

# Practical Computing

85p July 1984  
Volume 7 Issue 7

**The robots  
are coming**



**Man v Machine. How David Levy beat  
the World Champion chess computer**  
**Reviews – Epson PX-8, Apple IIc, Jane  
Open Access, Oric Atmos, CBM 64 games**

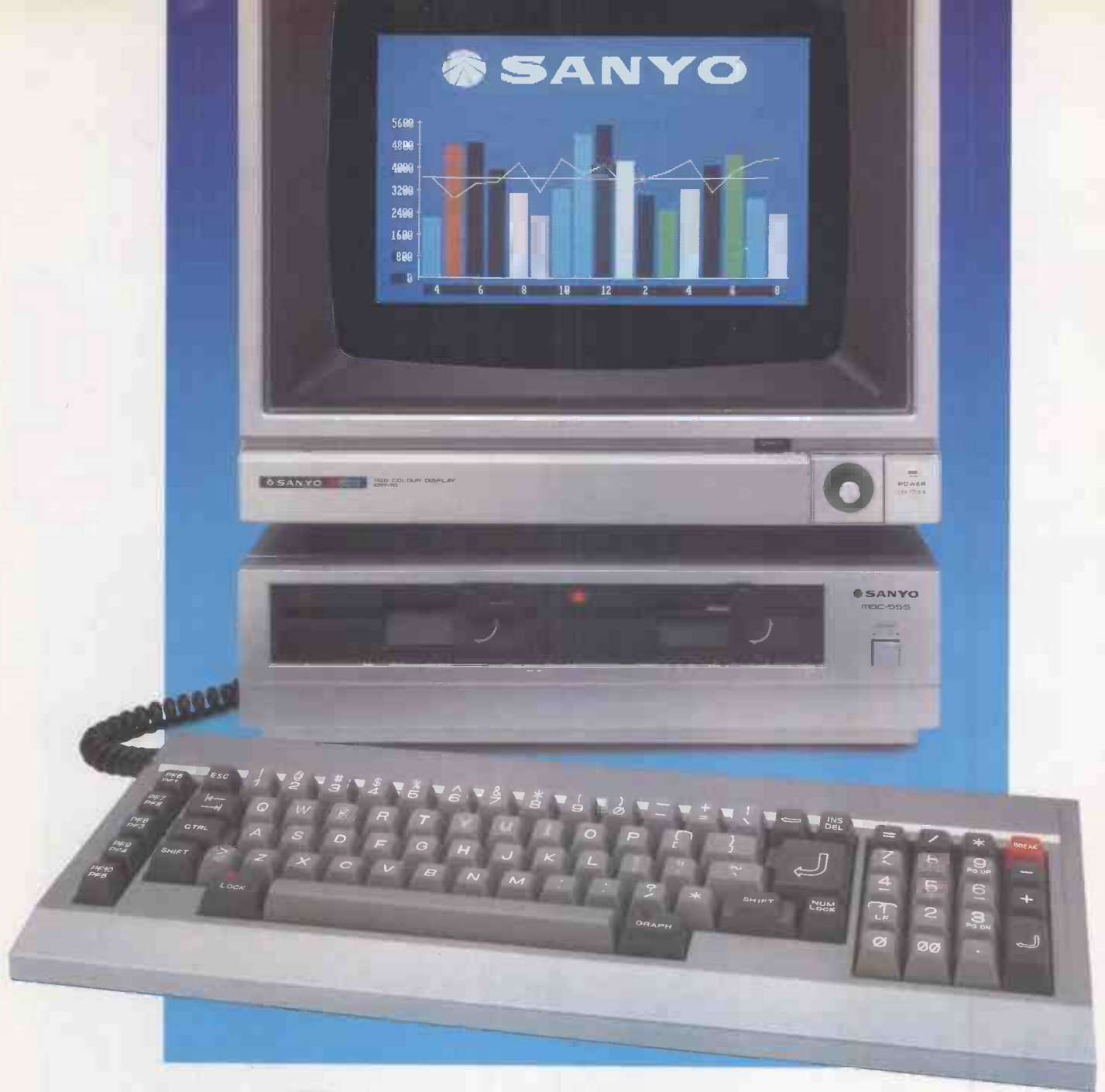

# BY NEXT YEAR, EVEN IBM MIGHT HAVE ONE.

This is the Sanyo MBC 555.

The first high performance business machine of its kind to offer the compatibility and versatility of a true 16-Bit business micro for less than £1,000 + VAT.\*

A revolutionary price for a revolutionary machine because with 128K RAM expandable to 256K RAM, both the twin drive MBC 555 and the single drive MBC 550 have an 8 colour graphics capability (640 x 200 dot resolution), an 8088 CPU for high-speed processing, a Centronics parallel printer interface and free bundled software.

Add to this the support of a compatible

range of peripheral equipment, a comprehensive selection of software and a price tag of less than £1,000 + VAT (MBC 550 £749 + VAT) and you'll probably understand why this package is so attractive.

But the real beauty of the MBC 555/550 series is that you don't have to wait until next year for them.

If you want to see these two innovative machines from Sanyo's proven range of Micros phone LOGITEK on 0257 426644 or STC on 0279 26777 or ICARUS on 01-485 5574 or clip the coupon and we'll show you how to stay one step ahead.

Name	_____
Company	_____
Position in Company	_____
Address	_____
	_____
Tel: no	_____ PC 2
Return to: Marketing Dept., Sanyo Marubeni (UK) Limited, Sanyo House, 8 Greycaine Road, Watford, Herts.	

\*EXCLUDING MONITOR.

2  
● Circle No. 101



SEE SANYO, THEN DECIDE  
**SANYO**

# LIST

PRACTICAL COMPUTING

JULY 1984



## >NEWS

- 13 HARDWARE NEWS**  
Commodore's back in business, Acorn's Z-80 box arrives, and more.
- 21 IBM PC NEWS**  
North Star enters the look-alike market, more micros and software.
- 29 SOFTWARE NEWS**  
Integration from Ashton-Tate, accounting software for the Apple Mac, Bible stories and insurance.

## >FEATURES

- 62 REVALUATION**  
How do the new Atmos, Amstrad and Tatung home micros look against what's already available?
- 82 CHESS — LEVY'S \$5,000 CHALLENGE**  
David Levy's own account of how he beat the World Computer Chess champion.
- 86 MASTERS OF LANGUAGE**  
John Backus, inventor of Fortran, meets Charles Moore, inventor of Forth.
- 90 PROGRAMMING THE BBC FUNCTION KEYS**  
John Dallman explains how they work, and supplies a listing in machine code.
- 96 HOME ACCOUNTS ON THE SPECTRUM**  
A program to sort out your budget, provided by Paul Cobb.
- 102 SCREEN COPIER FOR CP/M SYSTEMS**  
A machine-code utility for redirecting output, provided by Timothy and John Lee.
- 109 SURVEY — MICROS THAT CAN GROW**  
Glyn Moody picks eight of the best expandable systems.

**112 FICTION THE DUMB ORACLE**  
A day in the ideas factory, in Barrie Condon's story.

## >HERE COME THE ROBOTS

**116 AN INTRODUCTION TO ROBOTICS**  
Glyn Moody reviews the history of robots, and looks ahead to a burgeoning future.

**120 MAKING A MICROMOUSE**  
Leading mouser Alan Dibley explains the techniques.

**122 TURTLE TUSSLE**  
Christopher Roper looks at how turtles are taking over in schools.

**124 BORIS ALLAN MEETS HIS HERO**  
Our controversial contributor makes a mechanical friend.

**126 ROBOTS THAT WORK**  
Steven Sonsino surveys robot devices for the factory floor, or for linking to your micro.

**128 THE CRAFTSMAN ROBOT PROJECT**  
John Billingsley on the intelligent approach to automation.

## >REVIEWS

**55 HP GYPSY**  
Glyn Moody takes a look at Hewlett-Packard's true lap portable.

**58 ORIC ATMOS**  
Fin Fahey tries out the Oric with a new ROM, new case and disc drive.

**64 EPSON PX-8**  
The most powerful lap computer yet is tried and tested by Ian Stobie.

**68 APPLE IIc**  
Transportability comes to the IIc, along with a built-in disc drive — preview by Ian Stobie.

**70 PRODUCTS FOR THE APPLE II RANGE**  
Apple upgrades its operating system; Roger Cullis reports on the results.

**72 SEE JANE RUN**  
Integrated software hits the eight-bit micro: Apple now, Commodore 64 and Atari to follow.

**76 OPEN ACCESS**  
Paul Myerscough investigates an integrated program for the IBM PC.

**80 BRAINSTORM**  
Chris Bidmead reviews Caxton's "thought processor". Is it a breakthrough?

**136 COMMODORE 64 GAMES ROUND-UP**  
What's new? Dinky Doo — a palpable hit, plus old faithfuls from Atarisoft.

**173 SPECTRUM BOOKS**  
The volume keeps expanding. Bill Bennett checks out a selection.

## >REGULARS

**5 EDITORIAL**  
How will robots and communications change the way we work?

**7 FEEDBACK**  
Your letters — suggestions, corrections, pleas for help . . .

**37 CHIP-CHAT**  
Ray Coles looks at video display controllers.

**45 SOFTWARE WORKSHOP THE SHELL SORT**  
Mike Lewis helps sort out your sorting problems.

**145 OPEN FILE**  
Free programs for the Apple, BBC, Commodore 64, Sinclair, Atari and other popular micros.

**181 LAST WORD ON EDUCATION**  
Lorraine Boyce reports on a book which is making an impact among teachers.

Cover photography by Brad Guice; courtesy of American Craft Council, New York.

# The great letter race!



**Royal Mail**  
24 hour delivery

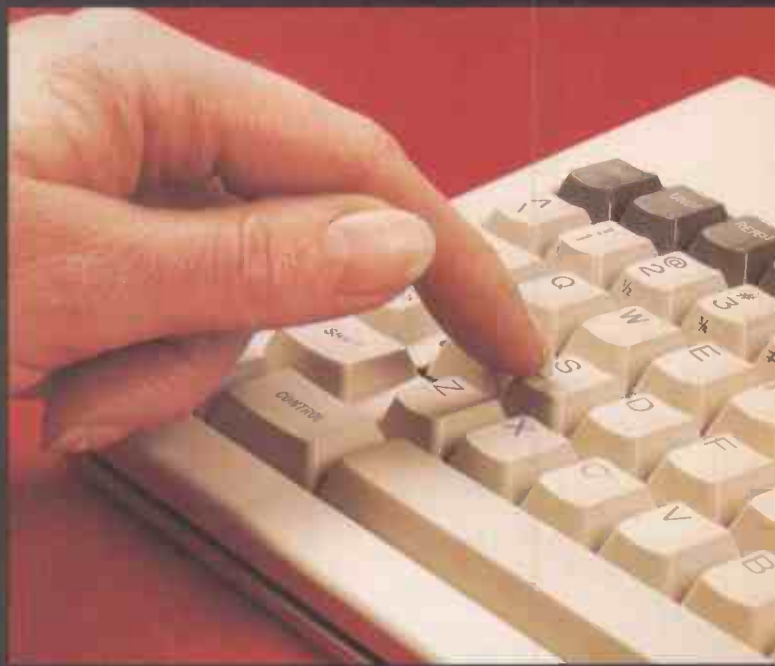

 **MICROMAIL**  
186,000 miles per second

In the great letter race ACT Micromail comes 1st every time. Micromail is an electronic mail system which sends letters, documents and files, both locally and internationally, at the speed of light. This rapid transmission enhances management information flow, giving you more time for important decisions.

Available on the ACT Sirius 1, Apricot and IBM PC Micromail is a fast and inexpensive alternative to Royal Mail. A letter of 400 words costs under 20 pence to transmit and copies can be sent simultaneously to 500 people at no additional cost. Micromail may also be used to send telex messages without the need for expensive terminals.

For Apricot users, the optional internal modem board can dial for you, so a telephone handset and acoustic coupler are unnecessary.

If you don't want to get left behind in the race fill in the coupon below.



**Applied Computer Techniques Limited**

ACT House,  
Telephone Avenue,  
Bristol, BS1 4BS  
Tel: 0272 211733



**MICROMAIL**

**1st every time**

Please return the coupon to The Micromail Sales Department, Applied Computer Techniques Ltd, ACT House, Telephone Avenue, Bristol BS1 4BS

• Circle No. 102

Name \_\_\_\_\_  
 Position \_\_\_\_\_  
 Company \_\_\_\_\_  
 Address \_\_\_\_\_  
 Tel. No. \_\_\_\_\_ PC 84

Working

EDITORIAL 01-661 3609

Editor Jack Schofield
Assistant Editors Ian Stobie Glyn Moody
Art Editor Stephen Miller
Production Editor John Liebmann

Sub-editor Carol Hammond
Editorial Secretary Sue Jordan
Consultants Chris Bidmead Peter Laurie

ADVERTISING 01-661 3612
Advertisement Manager Ian Carter 01-661 3021

Assistant Advertisement Manager Paul Braybrooke 01-661 8626
Advertisement Executives Lynne Brennan 01-661 8100 Mike Crimp 01-661 8425 Chris Markiewicz 01-661 3633 Janet Thorpe 01-661 3468 Advertisement Secretary Julie Darvill

Midlands office: David Harvett 021-356 4838
Northern office: Geoff Aikin 061-872 8861

Classified: Claire Notley 01-661 8163

PUBLISHING DIRECTOR Chris Hipwell

Published by Electrical Electronic Press, Quadrant House, The Quadrant, Sutton, Surrey SM25AS. Tel: 01-661 3500. Telexigrams 892084 BISPRS G.

Distributed by Business Press International Ltd, Quadrant House, The Quadrant, Sutton, Surrey SM2 5AS.

Subscriptions: U.K. £13 per annum; Overseas £19 per annum; selling price in Ire subject to currency exchange fluctuations and VAT. airmail rates available on application to Subscription Manager, Business Press International Ltd, Oakfield House, Perry Mount Road, Haywards Heath, Sussex RH16 3DH. Tel: 0444 459188.

Printed in Great Britain for the proprietors Business Press International Ltd by Eden Fisher (Southend) Ltd, Southend-on-Sea. Typeset by Centrepoint Typesetters, London EC1.

© Business Press International Ltd 1984

would-be authors are welcome to send articles to the Editor but PC cannot undertake to return them. Payment is at £35 per published page. Submissions should be typed or computer-printed and should include a tape or disc of any program. Hand-written material is liable to delay and error. Every effort is made to check articles and listings but PC cannot guarantee that programs will run and can accept no responsibility for any errors.

CURRENTLY many of us are wondering if, in the near future, we will be working from home. In fact, many of us are wondering if we will be working at all.

With robots taking over production, we could find ourselves in a similar position with manufactured goods as we are now in with agricultural products — able to produce embarrassingly more than we can consume.

This still leaves the question of what the displaced workers do, but the problem has been faced before. At the end of the agricultural age, for example, many were close to despair. What would people do if they did not work on the land? How would they earn a living? The idea that industry — making things — could be a vast and continuous employer of labour was grasped by very few.

The idea that industry will stop being a vast and continuous employer is equally hard to face, but its repercussions will be far reaching. The information economy will clearly lead to a different form of social organisation from the agricultural and industrial societies which have preceded it.

In agricultural times people had to live at their place of work, and the hours they kept were the hours of the sun and the seasons. In the industrial age people started to travel to work, and the hours were — and are — mechanistic. In factories people work in shifts; they clock on, take breaks and clock off at predetermined times.

In the information age, many people will be able to work anywhere and at any time. The workplace might be defined as any point where you can plug in a modem. Hours and jobs will become increasingly international because the information industry never sleeps.

We can see the beginnings of the breakdown of mechanistic ways of doing things all around us now. The Open University, with its tuition by television, is an example. It illustrates that everyone does not need to be in the same place at the same time to follow the same university course. Of course, the Open University is based on technology several decades old, and could

theoretically have been started in the 1940s. It wasn't, partly because there were not enough TV sets around.

Society's ideas were different, too. Centralised industries and large corporations were the favoured types of organisation. In computing terms this suited the all-powerful data-processing department running a mainframe. Today we are more aware of the power of distributed processing and networking.

It seems more than likely that a significant proportion of the population will have access to microcomputers and thus to the international information network. Not all the participants will have the same motivation, but there are enough possibilities to attract a wide audience. Information businesses are already putting regional offices, travelling salesmen and engineers on-line.

There are a number of companies selling network services as added value along with something else. Micros are already being built into some new houses, while through microcomputer-based controllers, cable-television operators can offer a variety of services along with their films and pop videos. Banks, stores, building societies — the Nottingham is already doing it with Homelink — and British Telecom also have opportunities.

It still seems likely that the lowly home computer will be what secures the largest market penetration, through offering the most fun for the least money, as did television. After all, the Open University became possible not because a few enlightened people wanted to make up for their missed educational opportunities, but because millions of people wanted to watch Coronation Street. In whatever guise the network of communicating micros comes about, there is no doubt it is on the way.

We will probably have to revise our idea of work. Certainly we will have to revise our idea of education. These things will change whether we approve or not. But whatever happens it is not enough just to fear the worst. We owe it to ourselves and our children to strive for our vision of the best.

Advertisement for Intel 8088 microprocessor. Features a graphic of the microchip, the text '5 Years ago ...', and technical information about the 8088 processor. Includes the headline 'Prepare for arrival of world's fastest eight-bit micro' and describes the 8088's 16-bit architecture and compatibility with 8086.

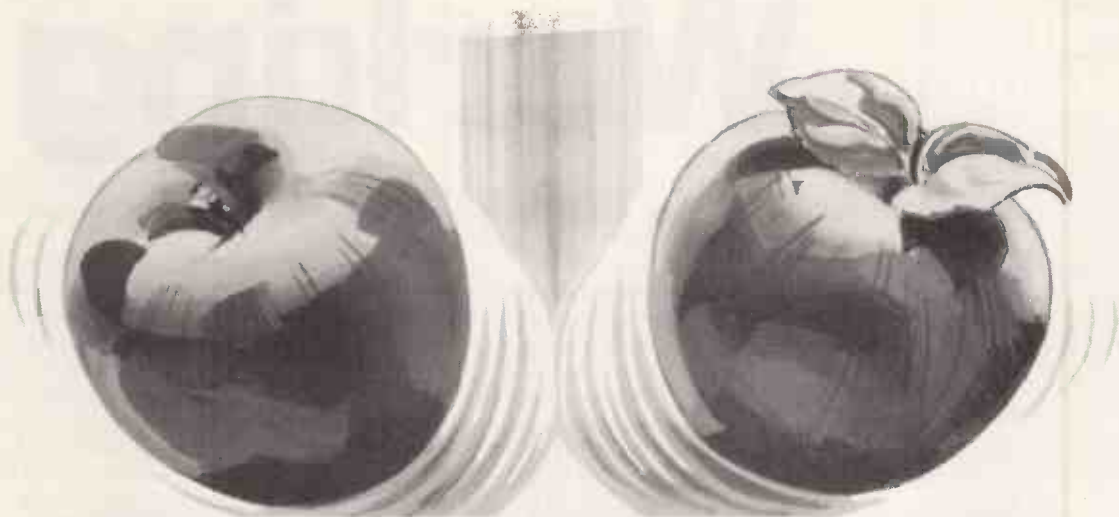

## TWICE THE SPEED

---

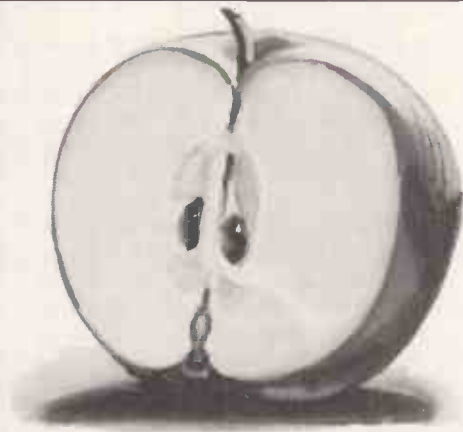

## HALF THE PRICE

---

### The new Practical Spreadsheet for Apple Computers

At twice the speed of Visicalc, and with a host of additional features unmatched by other programs, PractiCalc II just has to be the best spreadsheet for your Apple.

Not only does it have all the features you'd expect of a first class spreadsheet, it also acts as a database. It will automatically arrange information numerically or alphabetically and allows you to search for and retrieve information in seconds.

PractiCalc II also has an extensive word processing capability, enabling

you to create and justify text for letters or documents. In many cases, this eliminates the need for a dedicated word processor.



Add to this the higher speed at which it copes with all the usual mathematical and trig functions of the spreadsheet, (add, subtract, multiply, divide, square, root, logs and exponential), at a price far below that of any vaguely comparable program.

You'll soon see that PractiCalc II is destined to be the apple of every owner's eye. Pick one up for £69.95 at any Apple dealer or phone PractiCorp on 0473 462721.



## PRACTICORP

PractiCorp, Goddard Road, Whitehouse Industrial Estate, Ipswich IP1 5NP. Tel: 0473 462721.

● Circle No. 103

# RML Logo

I AM VERY UPSET by Boris Allan's ludicrous allegations about the version of Logo we wrote for Research Machines Limited. Does he really think that we would make the language difficult in order to force students to copy their teachers? That we are opposed to creative, experimental work and that we have tried to prevent it by making it too hard?

What nonsense! The reason you write

ADD 2 3

in Logo is that it is a closer approximation to "add 2 to 3", the normal English, than "2 + 3" is. Remember that the notation "2 + 3" took thousands of years to arise. Computer freaks may find infix easy; children don't.

There are various drawbacks to using infix with children. First, children can find it hard to understand priority. The expression

2 + 3/4

for instance, is likely to be misunderstood. Secondly, it introduces errors of syntax.

1 + FIRST [2 3]

is legal in Terrapin Logo, but

FIRST [2 3] + 1

is not. Thirdly, it is undemocratic: you cannot create new infix operators, though you can create new prefix ones. —

Our version of Logo has been under development for six years and it has been piloted on 200 children in all sorts of schools. This is a longer record than MIT Logo had when it was launched.

Over the past few months Boris Allan has made a number of attacks on this project's work. At no time has he ever asked anyone in this department for an account of the rationale that underlies Logo's design. I am afraid that I do not think this sort of ill-informed vilification ought to be published by a reputable journal.

Finally, the department runs courses for anyone with a special interest in Logo. Details in exchange for a stamped addressed envelope. These are one-week summer courses intended for teachers and others who use computers in schools.

**K R Johnson,**

**Department of Artificial Intelligence,  
University of Edinburgh.**

● **Boris Allan replies:** I had thought that my comments on the

drawbacks of RML Logo were sufficiently well-reasoned to be accounted sensible. Of course I do not think that the language was deliberately designed to be difficult to use, and I did not suggest so in my review. Mr Johnson has created a straw reviewer.

One of my examples was the different forms available for producing arithmetical assignments, using infix and prefix forms. Terrapin Logo uses infix only; RML Logo uses prefix only — with one strange, illogical exception; LCSi Logo allows the use of both forms.

I am an ordinary person and, like most ordinary persons, I have no difficulty with infix. I also have no difficulty with postfix notation, as used in Forth, and which is a more natural form than prefix. I find the concept of the "undemocratic" nature of infix strangely beguiling.

I have in the past — for example, in my book *Introducing Logo* — raised some queries regarding RML Logo. However, the idea that I have never looked into the rationale is incorrect. I have both questioned Mr Johnson personally, at the BLUG conference last September and participated in an RML Logo course run by a member of his department.

The philosophy of Edinburgh Logo is clear from the publications which emanate from the Edinburgh department. The objective is "to use Logo programming as a tool to teach specific curriculum concepts in a predetermined order. Children usually follow set courses of study instead of making up their own courses of study" — *The Hitch-Hiker's Guide to Logo* by Ken Johnson. This is why I consider Edinburgh Logo to be less child-orientated than most other versions.

● **The editor adds:** The quality and sheer power of Atari's LCSi Logo makes this one of the most important educational languages available today. The huge superiority of the Commodore 64 version of Terrapin Logo over the poor Commodore 64 Basic make it an almost mandatory buy. The quality of the Sinclair Spectrum version of LCSi Logo, and the huge number of Spectrums sold, make this an important introduction.

With similar MIT-inspired Logos appearing on the IBM PC and a dozen other machines, with combined sales running into several millions, it would seem that MIT Logo qualifies as the *de facto* standard. In spite of our admiration for work done in AI at Edinburgh, this version of Logo cannot now be more than an interesting backwater in the development of the language. Sad, but true.

Incidentally, as a matter of record, we choose our reviewers with care and we do not tell them what to write.

## Printers needed

I AGREE wholeheartedly with what Derek Trayler says in Feedback, May 1984, on the subject of word processors and printers. Manufacturers, software houses, suppliers and reviewers — none of them ever think to mention that you can do very little with a word processor without a decent printer.

My Easyscript, which was part of a good offer with a Commodore disc drive unit, is still in its box awaiting the time when I am able to purchase a suitable printer to go with it. And I would point out to Derek Trayler that having got your

micro and selected what you think might be a suitable printer, you still need to check up whether a further interface is needed.

I was glad to notice however that a little further on in the same issue the Software News item on music scores does state which printer is specifically needed to operate the package. You do at least know what you are letting yourself in for.

**Reginald A Mascal,**  
**Bristol.**

## Alive and booting

LATE YESTERDAY I purchased the May issue of *Practical Computing*. Since then I have only had the opportunity to

quickly read your article "Live and booting" but I have done so at least twice.

I want to take this early opportunity of congratulating Chris Naylor on an interesting and informative piece of work, made the more so by the many diagrams. Thank you also for the mention which you made of this company and our Scilabar Power Polishers. In passing I also mention that we have some refinements on the stocks to extend the range in the near future.

The captions "Transverse mode" and "Common mode" at the head of page 119 seem to have been reversed, but you may find consolation by reflecting that the Bible has been around for centuries and I understand that they have yet to produce one without a printing error.

**Alec Schofield,**  
**Scilab Ltd,**  
**Coalville,**  
**Leicestershire.**

(more letters on next page)

Our Feedback columns offer readers the opportunity of bringing their computing experience and problems to the attention of others, as well as to seek our advice or to make suggestions, which we are always happy to receive. Make sure you use Feedback — it is your chance to keep in touch.

## Anglo-Italian group

MICROMED produces a English-Italian bilingual newsletter devoted to all uses of microcomputers in medicine. The annual membership fee is £5 to cover printing and mailing costs, and submissions for publication are welcome. For more information please contact me at the address below.

**Francesco Di Girolamo,**  
vle della Rimembranza 25,  
66034 Lanciano,  
Italy.

## BBC users, phone Stockholm

WE WOULD like to inform you of the existence of our Swedish BBC users' group, BUG. The group was formed in October 1983 and we publish a monthly newsletter. Another service for the members is our own on-line database, devoted entirely to the BBC.

We very much want British BBC users with a modem to call our database, which can be used to send electronic mail, download or upload software, play games and lots of more. The phone number from Britain is Stockholm (010 46 8) 46 35 28.

**Anders Wickman,**  
BUG,  
Folkungagatan 58,  
116 22 Stockholm,  
Sweden.

## Tomorrow's Office

I NOTICE the word "contrasts" in your recent article concerning our product Tomorrow's Office, and Delta and Rescue. I

think it should be pointed out right at the outset that the primary contrast which must be seen above anything else is that Tomorrow's Office is a complete systems generator, designed specifically for that function, and the other two are single-level record-keeping systems. Once that is established, a number of the statements made in the article fall into context.

I would like to state for your readers' benefit that there are three versions of Tomorrow's Office: Tomorrow's Office Junior, which is the most comparable with Rescue and Delta, is £250, only needs 128K of RAM and comes on three discs; Tomorrow's Office (Mid Range) requires 256K of RAM and costs £495; and Tomorrow's Office Multifile, which requires 256K, costs £745 and is best on a Winchester.

**N D Hewitt,**  
Sosoft,  
Poole,  
Dorset.

## Micro medicine

WE ENJOYED your article "Health and efficiency". However, the article left out the main component: how the programs reviewed actually help in the health and wellbeing of the user, and how much information can be used efficiently in caring for the sick program owner. If the provider of medical care — that is, the doctor — is not incorporated in the decision-making authorised by the program, then the program is virtually useless.

The program information both in input and output must contain medically relevant facts. Most of the programs reviewed would not be helpful in the efficient delivery of health

care. Computer Medica Corporation has, in concert with a series of doctors conversant in computers, developed a series of programs to be used by patients and doctors alike to produce a patient medical report from a series of 247 questions. This patient history is filed on floppy disc by an Apple or IBM PC micro, and can be retrieved later by the doctor or hospital.

The idea that the physician will be replaced by an inanimate machine is as likely as having all the politicians so displaced.

**Derek M Enlander,**  
Computer Medica Corp.,  
Centre Moriches,  
NY 11934.

## Sinclair Logo

IN MY REVIEW of the four versions of Logo, I noted that the version for the ZX Spectrum had errors in the numerical routines. The errors arose because the Logo system uses the Spectrum Basic floating-point routines, and these routines have a bug in the way in which the numbers are stored.

I pointed out in my review that it would not be possible to put Logo on a separate ROM, because of the use of the Basic routines.

The system I was using was a prototype. Before the review appeared I communicated my findings to Sinclair Research, who corrected the Logo bug. The arithmetic does not now use Basic floating-point routines. Logo can now appear on ROM, and the arithmetic is correct.

The speed at which LCS1 and Sinclair corrected the error, once notified, is commendable, and Sinclair Logo is now working correctly in all respects I have tested.

**Boris Allan,**  
Bramhall,  
Cheshire.

## Budget business systems

In last month's Top Ten feature on budget business systems a production error led to the wrong For and Against comments being printed against the five machines on page 127. The comments as we intended them to appear are as follows:

- SANYO 555 For. Good bundled software. Colour display capability. Against. Limited expansion possibilities.
- WREN For. Good value. Fast processor. Built-in modem. Prestel capacity. Against. Keyboard not detachable.
- LYNX LAUREATE For. British. Low price. Against. Small keyboard. Long-term reliability and support unproven.
- MICRONIX MX-400 For. British. Industry-standard CP/M machine. Flexible range of disc options. Cheap. Against. Not much.
- MEMOTECH FDX For. British. Good disc options. Good keyboard. Well-made. Looks attractive. Against. Long-term reliability and support unproven.

## Work unit

AS A PART of my A-level design course I am designing a computer desk or work unit with the home user in mind. At the moment I am investigating what form one of these units should adopt, whether an expandable system or a solid single unit. I would be very grateful for any ideas from readers of *Practical Computing*.

**S Plenderleith,**  
Kirbie Kendal School,  
Lound Road,  
Kendal LA9 7EQ. ☐

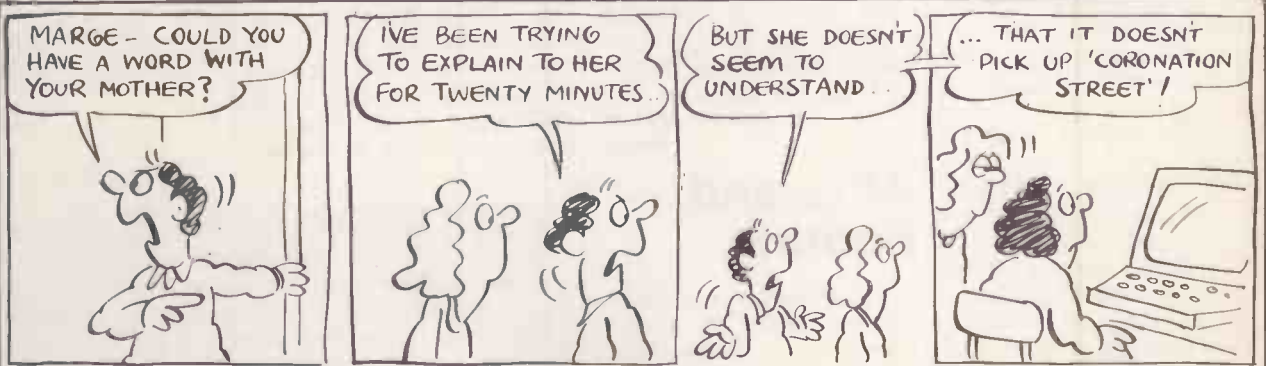

Hill



# Back up for the Future!

## THE INTEC HARD DISC RANGE FOR THE APPLE & BBC MICRO



- ▶ Full file handling and diagnostic software utilities.
- ▶ Full compatibility with all BBC & Apple Software.
- ▶ Easy and Fast back up routines.
- ▶ Data capacity from 5 Mb upwards.
- ▶ High Access Speeds
- ▶ UK Design and Manufacture

The INTEC range of Hard Disc Systems – capacity from 5-20 Mb and includes the revolutionary fixed and removable INTEC 5o5.

INTEC 5o5 – all benefits of a Winchester sub-system plus the ability to use a removable hard disk for a compact, secure and usable back-up or cartridge per application approach.

Why pay more for less – choose INTEC.

For full details complete and post the tear-off slip or phone **INTEC now – 01-761 5999**

**INTEC**  
41A-45 Knights Hill  
West Norwood, London SE27 0HS  
Telephone 01-761 5999, Telex 8813271 GECOMS G

INTERFACE TECHNOLOGY

# INTEC

Please Cut Out and Return  
The INTEC Hard Disc Range  
5-20 Mb Winchester and the fixed and removable 5o5.  
NAME \_\_\_\_\_  
ADDRESS \_\_\_\_\_  
BBC And APPLE \_\_\_\_\_ 9

# Will next year fit your new



If you're thinking of buying a personal computer for your business, you've plenty to choose from.

But, with most of the new programs being written for one computer system, the field narrows.

You obviously want a computer that will be compatible with the most popular system.

But, sadly, many of the so-called compatibles are not what they claim.

 The new XTRA from STC, however, can offer

the very highest level of compatibility so far achieved.

In other words, full operational compatibility with the IBM PC/XT.

So, it will run virtually all the same proven programs.

It accepts the same size floppy disks.

And it will link up with the same important add-ons.

Apart from the obvious advantages, the XTRA also has a smaller central processor than most. And, if you still find yourself cramped for desk-space,

# ar's software computer?



you can even turn it on its side.

The XTRA also boasts a friendlier keyboard and a screen that tilts and swivels for more comfortable viewing.

If you'd like more information simply dial 100 and ask the operator for Freefone XTRA.

Once you've discovered the XTRA, you'll wonder what the others are fit for.

## XTRA

Personal Computer.

STC BUSINESS SYSTEMS LTD., BUSINESS MICROCOMPUTERS, MAIDSTONE ROAD,  
FOOTS CRAY, SIDCUP, KENT DA14 5HT.

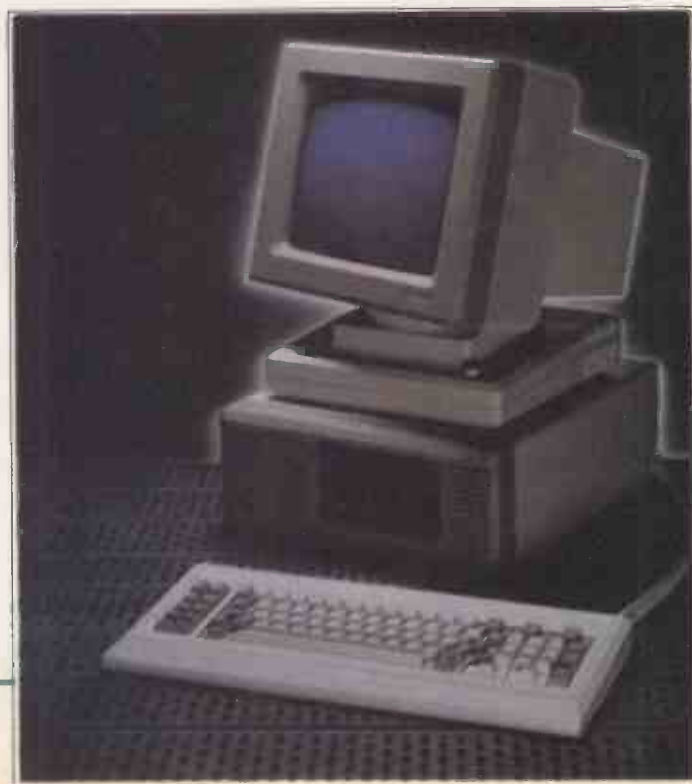

● Circle No. 105

NOW WITH 16-BIT MASTER PROCESSOR

## Mini's too expensive

For a multi-user business system expandable to 16 screens you used to need a sizeable mini, say from **DEC** or **Burroughs**, with a hefty price-tag for hardware and software, with long time-scales.

## Micro's too small

Micros, like **Altos**, **Sage** and **Rair**, 8-bit or 16-bit, are doomed by CPU degradation, being based on the time-sharing principle. PCs, like **IBM** and **Apricot/Sirius**, just aren't in this league at all, networked or otherwise.



## SuperStar<sup>+</sup> multi-user system...

...is just right

**SuperStar** is a multi-processor system in which up to sixteen 16-bit processors, each with up to 1Mb RAM, are integrated in an attractive desk-top unit. All users can work at full speed in genuine multi-user, multi-tasking mode with full file/record locking and spooling.

At half the price of a mini and a give-away price for the world's largest selection of software, **SuperStar** is just right for any multi-user application.

£5975 buys a complete 2-user high-performance system, with 10Mb winchester and VDUs. Additional users for £995 each, including VDU and processor.

Supports all **CP/M** and **MS-DOS** programs as well as the wide range of **BROMCOM** genuine multi-user software.

# BROMCOM

417-421 Bromley Road, Bromley, Kent BR1 4PJ  
Tel: 01-697 8933 Telex 896691 TLX1RG

OEM, Dealer and Overseas enquiries are welcomed.



SuperStar is a trade mark of Bromley Computer Consultancy. CP/M is a trade mark of Digital Research. MS-DOS is a trade mark of MICROSOFT.

SuperStar-16 has a 16-bit Master Processor which runs IMPOS (BROMCOM designed true 16-bit controlling operating system). IMPOS supports CP/M, MS-DOS and shortly Xenix in slave processors in any combination and it is fully upward compatible with ACTION DPC/OS, Televideo MimmOST and TurboDOS.

## NEW GENERATION MULTI- PROCESSING SYSTEM

IMPOS® (Intermixed Multi-processing Operating System) is upwards compatible with TurboDOS, Television MmmOST, Action DPC/OS and MP/M + CP/NET software but with a difference. It is written in the highly transportable language C which runs in 16-bit and 32-bit master processors with a much higher degree of performance and sophistication.

Further, while others offer only CP/M80 or CP/M86 compatibility, IMPOS® supports a much wider choice of the most popular operating systems for the slave processors i.e. CP/M80, CP/M Plus, CP/M86, Concurrent CP/M86, MS-DOS and XENIX all working simultaneously sharing common resources.

## GENUINE MULTI- USER ENVIRONMENT

Same generic operating system (i.e. Digital Research vs MicroSoft) within the same system have full genuine multi-user facilities e.g. record / file locking.

The fact that all previous generation multi-processing software written with the constraint of 8-bit instruction sets and, of course, a memory size of 64Kbyte of RAM makes them rate very poorly against IMPOS® which has been implemented with 16-bit and 32-bit instruction sets and 1Mbyte of memory space. Of course higher processing power is an added bonus. Wide area networking over Ethernet is also supported.

## SUPERSTAR 16™

BROMCOM® SuperStar 16™ is the first implementation of IMPOS®. Superstar™ is a desk top system with integral winchester of up to 80Mbyte and a tape streamer of 40Mbyte. Slave processors are Z80A with up to 128Kbytes or iAPX186 with up to 1Mbyte RAM. A total of 16 Slave processors can be accommodated in any combination while the current Master processor is an 8086 with up to 1Mbyte of RAM.

For more information ring 01-697 8933 and ask for Bob Bartlett.

## News: hardware

# Commodore models announced

JUDGING BY the recent spate of announcements and launches, Commodore seems to be adopting the blunderbuss approach to micros: throw anything and everything and something will prove a hit.

First, two new models in the 8000 series have been released in the U.K. The 8296 offers a 6502 with 128K RAM, integral screen and keyboard for £795. The 8296D is additionally equipped with an integrated 2Mbyte drive and costs £1,495. Both machines use Basic 4.0 and are software-compatible with the 8032 and 8096 computers that they supersede.

Other machines in the offing were announced at the Hanover Fair. The Commodore 16 is the new home micro, equipped with 16K RAM and a 32K ROM-based operating system with Basic interpreter. Though details have yet to be finalised

the basic design is similar to the trusty Commodore 64.

The Commodore Plus 4, designed for the no-man's-land between home and business, offers 64K RAM, a 32K ROM operating system, plus a maximum of 32K additional ROM for plug-in software. The home side of things is catered for by two tone generators, a cassette port and two joystick ports. Like the Commodore 16, the Plus 4 uses a domestic TV for its display but also possesses a monitor output. No prices have yet been announced for either machine.

Swallowing its corporate pride, Commodore has even announced its very own Commodore PC, complete with IBM PC compatibility. In addition to the bog-standard 8088 CPU a generous 256K RAM is provided as standard, with 160K of virtual disc

memory, two IBM-compatible 320K double-density dual-sided floppies, and serial and parallel interface ports. The machine is designed to be transportable, weighing in at a reasonable 21lb.; the screen size is currently 7in.

Finally Commodore has really taken the plunge with the announcement of a Z-8000 based machine. It is to be called the Commodore Z-8000, and will come with 256K of RAM supporting two terminals; enhancement to eight users is planned. Unix 7 is offered, along with assembler and C-compiler. There is a Centronics interface together with two programmable RS-232s. Plans to launch this brave-looking machine in the U.K. in June have now been shelved and, for all the Hanover machines, no prices have even been hinted at so far.

## Acorn growth

HARD ON THE HEELS of the 6502 second processor for the BBC Micro comes the long-awaited Z-80 add-on. As revealed in May's *Practical Computing*, the price is well below the £400 that was commonly being quoted — in fact the whole bundled deal costs £299 including VAT.

A generous quantity of systems and applications software is provided. From the Chang Laboratories comes the Plan series of Memoplan, Fileplan and Graphplan. There is a system generator called Nucleus, which won the 1984 RITA Software of the Year Award, and an integrated accounting system called Accountant.

Languages provided are CIS  
(continued on page 15)



A machine running a Z-80 at 2MHz with 16K RAM expandable to 48K may not sound earth-shattering, but the Radionics CNS computer is unusual in being geared toward control applications through the provision of six control and four sensing sockets. The same manufacturer also produces a mains switching unit for the control of electrical appliances. A project manual describes nine domestic projects varying from burglar alarms to a home-disco lights system. The micro possesses a full QWERTY keyboard, monitor and TV outputs, provision for an internally fitted disc controller board and a real-time clock. The CNS costs £200, and is available from Radionlc Microsystems Ltd, Avondale Workshops, Woodland Way, Bristol BS15 1QH. More information on (0272) 603871.

# KGB

## THE PRICEBREAKERS!

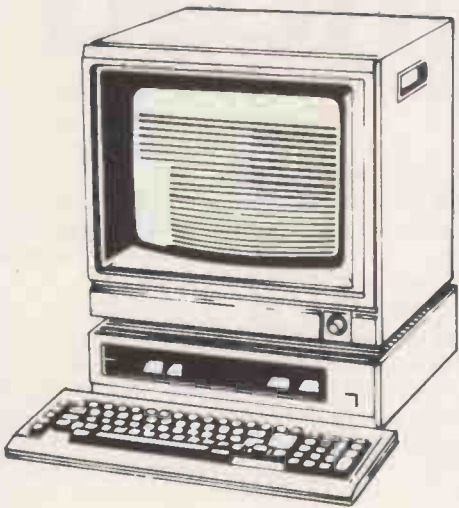

**NEW SANYO**  
**MBC 550**  
 16 Bit 128K RAM 1 x 160K Floppy, Screen, £876.00  
 MS DOS, Wordstar, Calcstar, Basic (EX-VAT)

**NEW SANYO**  
**MBC 555**  
 16 Bit 128K RAM 2 x 160K Floppies,  
 Screen, MS DOS, Wordstar, Calcstar, £1126.00  
 Infostar, Basic, Spellstar (EX-VAT)

### SIRIUS

**Sirius 1**  
 16 Bit 128K RAM 2 x 600K  
 Floppies, MS DOS, Graphics,  
 Screen, Basic £1795.00  
 (EX-VAT)

**SX**  
 as Sirius 1 but with superb  
 10MB Winchester and  
 1 x 1.2MB Floppy £3495.00  
 (EX-VAT)

**KGB'S SPECIAL  
 SUMMER OFFERS!**



### APRICOT

**Standard**  
 Full 16 Bit 8086 based Micro with 256K RAM, Mono  
 Screen, 2 x 315K Floppies, MS DOS, £1638.00  
 Supercalc, Basic, Superplanner (EX-VAT)

**KGB'S SPECIAL  
 SUMMER OFFERS!**

**NEW** Xi as standard Apricot but with 5MB £2425.50  
 Winchester in place of one Floppy Drive (EX-VAT)  
 with 10MB Winchester £2695.50  
 (EX-VAT)

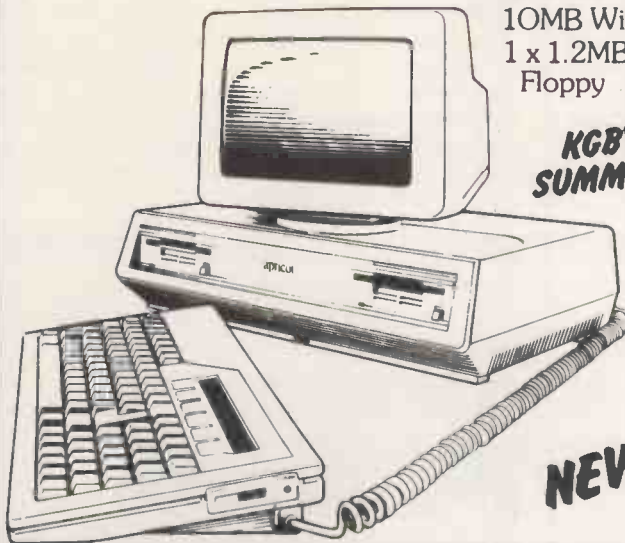

Join the **KGB Computer Club** free! Receive advance details of all new products and special offers plus informative KGB Newsletter.



106 St Leonards Road, Windsor,  
 Berkshire, SL4 3DD  
 Tel: Windsor (07535) 50111 Telex: 848521

Authorised  dealer Authorised **IBM** dealer  
 Specialists in Computer Aided Design

#### KGB COMPUTER CLUB

To: KGB Micros Ltd., 106 St. Leonards Road, Windsor, Berkshire SL4 3DD.  
 Please send me full details of the benefits I can enjoy  
 by joining the KGB Computer Club

Name

Position

Address

Tel:

PC7/84

● Circle No. 107

PRACTICAL COMPUTING July 1984

(continued from page 13)

Cobol, Z-80 BBC Basic — the Z-80 version of the standard Acorn dialect — and Professional Basic, a structured Basic, which was used in writing Accountant. CP/M 2.2 is supplied with the GSX Graphics System extension.

The Z-80B runs at 6MHz and comes with its own 64K of RAM. Under CP/M some 55K of this is available for applications programs. Communication is via the Tube, with the host 6502 processor handling I/O, screen graphics and all system routines.

Amid all this excitement Acorn has not been resting on its laurels. Not content with producing its own Z-80 unit it has now acquired Torch Computers, which has been selling micro systems for some time.

A slight different acquisition is Acorn's 25 percent stake in another Cambridge company, Torus Systems Ltd, whose first product, a graphics-controlled local area network for the IBM PC, is about to be launched with the suggestive name of Icon. Apart from fulfilling an obvious desire for a price of the IBM action, this deal gives Acorn access to skills in the fashionable areas of icons and communications.

## Two Tandys

TANDY has expanded its already extensive range of micros with two new machines. The Model 2000 offers an 8MHz 80186-based system running MSX-DOS, with 128K RAM expandable to 768K. Two versions are available, with double-sided double-density 720K floppies, or with one floppy and a 10Mbyte Winchester.

A 90-key QWERTY keyboard includes eight command keys and 12 function keys. Communications are provided by parallel and RS-232 serial ports. A high-resolution 12in. green or 14in. colour monitor displays 25 lines by 80 characters, with a pixel resolution of 640 by 400. System prices start at £1,999 plus VAT.

The Model 4P is a 261b. transportable. Its 4MHz Z-80A runs CP/M Plus as well as Tandy concoctions like TRS-DOS 6.0 and L-DOS. The 64K

RAM is expandable to 128K, and can be partitioned for use as a virtual disc. Two built-in 184K floppies are included as standard. The unit measures 16in. by 13in. by 9in. The cost is £1,303 plus VAT. Details from Tandy dealers.

## QLs arrive

AS REVEALED in last month's *Practical Computing*, the QL does exist. Some are even getting out to the public, but unfortunately the machines and software are rather wobbly.

One PC reader placed an

## Euromice at Birmingham

HOW DO YOU KEEP an audience in suspense about the outcome of a contest with only one mouse? Fullyautomatix was the only newcomer to make the pilgrimage to Birmingham for the novice contest at the Midland Computer Fair, although the open contest the following day had a full complement of eight mice. Alan Dibley brought a throng of Thezei, while David Woodfield brought Thumper and Knownaim.

The surprise winner was the veteran Thumper, finding its shortest route of 1 minute 23 seconds to the centre after 12 minutes of exploring. Knownaim found a route just two seconds shorter, but took 14 minutes to do it: under the new rules, Thumper scored 1 minute 35 seconds while Knownaim was second with 1 minute 36 seconds.

Alan Dibley's mice tried valiantly but failed to reach the centre of a very difficult maze with a somewhat lumpy base. Nevertheless he took second place, while the third prize was taken by Bill Urmenyi with Gonzales.

The great lesson for novices is: be proud of your mouse, however erratic its performance, and bring it along at all costs. There will be plenty of space at Earls Court to troubleshoot your mouse, or even to start building it from scratch.

order on January 12, and obtained the fabled machine on May 3. He reports that Easel failed to load on the second time of use, there were six cases of software failure from Microdrives and finally Abacus failed during a backup procedure.

Not unnaturally a little disgruntled at his bad luck, our reader high-mindedly decided to ask for a refund and sent the machine back on May 12. Which is rather impressive if you think of the hordes out there desperate to pay over the odds for a machine.

## Hawk attack

DIGICO has launched a range of British-built micros covering the field from first-time business users to eight-user office systems. The Hawk 200 is a Z-80 based machine with 64K RAM, two floppies holding 395K or 795K and a 12in. green screen. A hard-disc version is also available with a capacity of 6Mbyte. The cost is £1,495 plus VAT.

The Hawk 500 uses the 68000 CPU running at 8MHz under CP/M 68K, with Xenix as an optional extra. RAM starts at 128K and is expandable to 512K. There are four RS-232 ports and a choice of three keyboards, including one with WordStar-designated function keys. The disc options are the same as for the Hawk 200, with the additional possibility of a 12Mbyte Winchester. The price starts at £2,695 and goes up to £4,295.

The Hawk 600 also uses the 68000, has Xenix as standard and is aimed at the one- to eight-user market. Prices range from £7,000 for a 512K RAM 10Mbyte Winchester four-user system to £13,500 for a 1Mbyte RAM, 24Mbyte, eight-user system.

Top of the range is the Hawk 700, offering dual-processor architecture based on the 68000 and the 8088. Prices run from £5,500 to £15,000.

The assets of the old mini manufacturer Digico were acquired by Centreway Industries computer division which is now developing a range of micros. Details from Digico Computers Ltd, 32 York Road, Leeds LS9 8TD. Telephone: (0532) 486688.

## In brief

- Rair has launched two micros, based on the iAPX-286 and 287 respectively, which can use up to 2Mbyte of RAM and 100Mbyte of hard disc. Up to 16 users can be attached. Digital Research's Concurrent DOS and Unix V are both supported. Prices start at about £10,000. Details on 01-836 6921.

- The BBC Micro can now be made emulate the DEC VT-100 terminal using a £20 ROM chip from the Polytechnic of Central London. More information on 01-486 5811.

- Vector's VSX eight-bit and 16-bit dual-processor micro offers a Z-80B and 8086 with 128K RAM. Prices start at £3,800. More information on (07535) 69375.

- Hitachi has reduced the price of its PC by more than 20 percent, from £2,595 to £1,995. Details on 01-848 8787.

- Perkin-Elmer Data Systems has entered the U.K. micro market with a hefty 68000-based product offering 320K of RAM and a 15Mbyte hard disc as standard. The Perkin-Elmer is not cheap: £7,430 for the single-user work station. More on (0753) 77777.

- More PCs, this time from Zenith. Like just about everyone else's, Zenith's offering has an 8088, 128K RAM and one or two floppies. A dual disc-drive version starts the range at £1,995, which the 10Mbyte version costs £3,395. Details on (0452) 29451.

- A BBC Micro keypad extension has been produced by Extron. The unit costs £50 and offers numerals, arithmetic operators together with nine commonly used shifted characters. More on (02216) 2936.

- To complete the Apricot range, ACT has announced a 1.44Mbyte double-sided dual-disc machine. The micro will cost £2,095. More information on 021-454 8585.

*If you are thinking of buying more than one PC - think again about*

# Jarogate's MP5 the CP/M multiprocessor

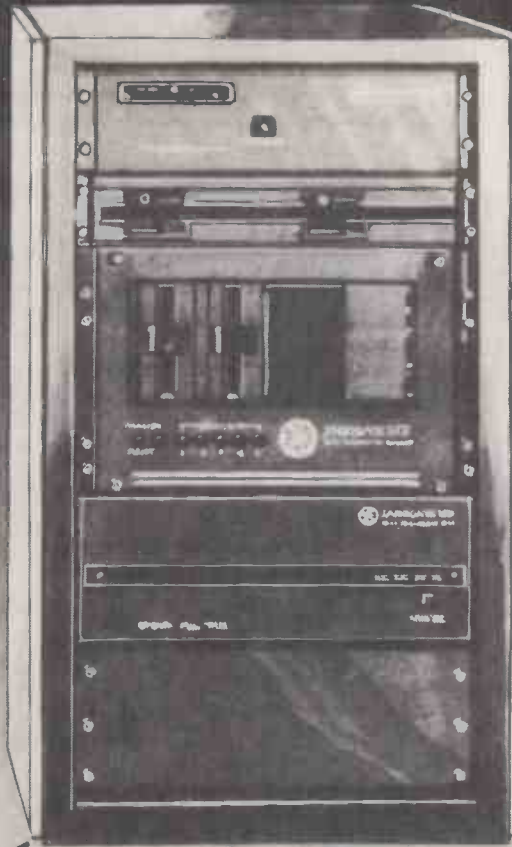

ICL/IBM  
& OTHER  
COMMUNICATIONS

CARTRIDGE & REEL  
TO REEL TAPE

PRESTEL

ETHERNET FOR  
MULTIPLE MP5  
CONFIGURATIONS

FROM 5 TO 600MB  
SHARED DISC  
STORAGE

MULTIUSER TELEX

PERPETUAL  
REAL TIME  
CLOCK/CALENDAR

UP TO 16 USERS  
EACH WITH 64K  
Z80B(6MHZ) & S100 BUS

SHARED PRINTERS  
AND PLOTTERS

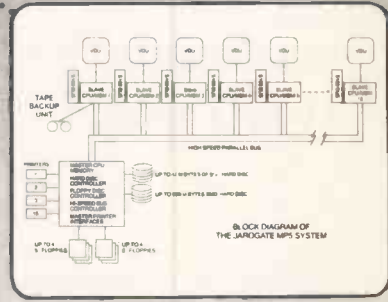

COLOUR GRAPHICS

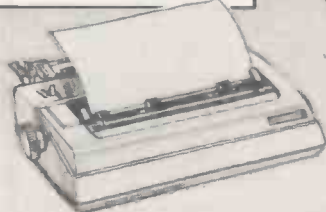

8 AND 5 1/4 FLOPPY DISC

Z80H (8MHZ) & LAPX 286 (16 BIT) PROCESSOR OPTIONS.  
WILL SUPPORT ANY CP/M OR MP/M APPLICATIONS SOFTWARE.

**YOU HAVE JUST THOUGHT  
ABOUT A BRITISH MADE, LOWER COST,  
HIGHER PERFORMANCE SOLUTION.**

FROM £1995.

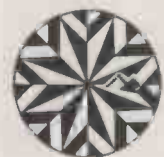

**JAROGATE LTD.**  
the microprocessor specialists

197-213 Lyham Rd., Brixton, London SW2 5PY Tel: 01-671 6321 Telex 8950094 JARO G

**NATIONWIDE  
MAINTENANCE  
SUPPORT**



# OKI Microline 92

## So fast - and NLQ



NLQ = Near Letter Quality.

It's just one of the many outstanding features which put the OKI Microline 92 matrix printer at the top of the 80 column league. Add to this standard print at 160 cps, high resolution graphics, downline-loadable character sets, subscript, superscript and underline capability, and you will see why the Microline 92 is an unbeatable price/performer.

The Microline 93 offers the same unrivalled specification to users requiring a full 136-column format.

And if all this is not enough, both machines are available with our unique IBM Plug 'n' Play Kit, ensuring full compatibility with the IBM PC.

An even more impressive feature list, including a print speed of 200 cps, defines the 136-column Microline 84. In addition to its increased throughput capability, the optional Automatic Cut Sheet Feeder permits maximum use of the near-letter-quality print mode.

Quality, reliability and unbeatable price/performance are of course hallmarks of the entire OKI Microline range, including the ever popular Microline 80, still a best-selling entry-level printer.

The range is completed by the Microline 82A (80 col) and the Microline 83A (136 col) which offer a print speed of 120 cps amongst a host of other features.

OKI Microlines - the unbeatable printer family!



# X-DATA

THE NAME BEHIND  
THE PRODUCTS IN FRONT

X-DATA LIMITED, 750 DEAL AVENUE, SLOUGH TRADING ESTATE, SLOUGH, BERKS SL1 4SH. TEL: SLOUGH (0753) 72331

a **Dyneer** company

● Circle No. 109

17

## ACCOUNTANTS

DESMET C COMPILER,  
MLH Technology,  
0606 891146  
INCOMPLETE RECORDS,  
IBIS Business Info Systems Ltd,  
061-860 7123  
FINAX TIMAX,  
Orchard Business Systems Ltd,  
0403 68461  
ACCSYS,  
The Data Processing Company Ltd,  
0303 41618  
AUDITOR,  
Trionic Software Ltd, 0482 867824  
WASP INCOMPLETE RECORDS  
SYSTEM,  
Wasp Software, 01-684 7979

## AGRICULTURE

FARMFAX CASH ACCOUNTS,  
Farmfax Services, 0703 66123  
DAISY—DAIRY INFORMATION  
SYSTEM,  
University of Reading, 0730 875123

## ARCHITECTS

DRAWINGS REGISTER SYSTEM,  
Abtex Software Limited, 0274 734838  
AJACS—ARCHITECTS JOB ANALYSIS,  
Mercator Computer Systems Ltd,  
0272 731079  
ARCOS—ARCHITECTS JOB COSTING,  
Insight Computer Systems Ltd,  
0602 470990

## AUCTIONEERS

AUCTION,  
Mercator Computer Systems Ltd,  
0272 731079

## BAKERY

BAKERY ACCOUNTS,  
View Data Torbay Ltd, 0626 60534

## BUILDING SERVICES

HEATSOFT 1, HEATSOFT 2,  
HEATSOFT 3, HEATSOFT 4,  
HEATSOFT 5,  
Contract Computer Software Ltd,  
01-659 4444  
CENTHEAT,  
Dual Business Systems, 0292 281776  
SPECWRITER,  
Hevacomp Ltd, 0742 661003

## CATERING

STORE CONTROL,  
Trionic Software Limited,  
0482 867824

## COMMUNICATIONS

SIRIUS/MICROWRITER COMMS,  
ABMS Computer Services,  
0273 24953  
BLAST BLOCKED ASYNCHRONOUS  
TRANS,  
Communications Research (UK) Ltd,  
0203 473015  
TELE-TERM TELETYPE TERMINAL,  
MCP Microsystems, 051-426 4178  
TANGO-LYNK,  
Network Designers Ltd, 0865 821177  
DRM 29 ICL/CO3 EMULATOR,  
VHA Computer Services,  
0532 737475  
DRM TELETYPE EMULATOR,  
VHA Computer Services,  
0532 732442

## CONSTRUCTION

CADS 3 ANALYSE, CADS 3: PORTAL-1,  
CADSSLIIP, CADSFOUL, CADSPAN,  
CADSTORM,  
Computer & Design Services Ltd,  
0202 697341  
E.M.S. PINS, E.M.S. PINS, E.M.S.  
FRAME 2 & FRAME 3, E.M.S. CBEAM,  
Davenport Computer Systems,  
021-359 0934  
STRAFE 1,  
H.W.D. Computing, 0272 741986  
FRAME-STRUCTURAL ANALYSIS,  
GRID-STRUCTURAL ANALYSIS,  
SLIP CIRCLE,  
Modray Ltd, 041-339 1203

SHEETPILE-2, SLIP CIRCLE-1,  
Pellon Ltd,  
04215 3768  
QUARRYMAN,  
Rural Computer Systems,  
0248 353782

## CONSTRUCTION

COMPUTER ESTIMATING,  
The Consultancy Consortium,  
04895 82103

## COSTING

SALES ORDER PROCESSING,  
Action File Software, 0608 41197  
BUILDER'S JOB COSTING,  
Aphros Software & Computers Ltd,  
0843 294699  
BOS/JOB COSTING,  
Barcellos Limited, 0533 541574  
MICROFACTS,  
Facts Software, 0234 218191  
EXECUTIVE JOB COSTING,  
Omicron Design Ltd, 0784 31809  
JOB/CONTRACT COSTING,  
SMB Computer Services Limited,  
0623 651651  
SYSTEMATICS JOB COSTING,  
Systematics Int Micro Sys Ltd,  
0440 61121

## DATABASE

OMNIS 1, OMNIS 3, ONMIS 2,  
Blyth Computers Ltd, 050270 371  
CARDBOX,  
Caxton Software Ltd, 01-379 6502

MANUFACTURING DESIGN CAE,  
Turnkey Comp Aided Engineering,  
0272 423704

## DISK UNITS

WINCHESTER DISK SUBSYSTEM,  
TAPE BACKUP SUBSYSTEM,  
Micro Memory Systems Ltd,  
0635 40405

## DRAUGHTING

DIGITMASTER,  
Jentech Services Ltd, 07462 61458  
MAEDOS, MAEVIS,  
Micro Aided Engineering Ltd, 0842 4041  
MLD, MLL,  
Mountford & Laxon Co. Ltd,  
021-354 5389

## EMPLOYMENT

PROFESSIONAL ACCOUNTING,  
A.P. Computer Consultants Ltd,  
0628 22428

## ESTATE AGENTS

ESTATE AGENTS,  
Action File Software, 0608 41197  
ASTROLABE ESTATES,  
Astral & Chambers Ltd, 0279 725812  
ESTAGENT,  
Mimex Business Systems,  
01-387 4599  
HOUSEAGENT,  
Spot On Software, 0934 32685  
THE ESTATE AGENTS PACKAGE,  
The Consultancy Consortium,  
04895 82103

## ESTIMATING

CURTAIN ESTIMATING SYSTEM,  
Aylesbury Computer Systems Ltd,  
0296 32591  
CODEWRITER,  
Dynatech Microsoftware Ltd,  
0481 20155  
MICROFIND,  
Intelligence (UK) Plc, 01-740 5758  
PROGEN PLUS,  
Limrose Software, 097 883 5555  
BOS AUTOINDEX—CARD INDEX,  
MicroProducts Software Ltd,  
01-831 8811  
TRENDISK/1,  
Microtrend U.K., 0423 711878  
AGENT, FILE 'N' FIND,  
Mimex Business Systems,  
01-387 4599  
SENSIBLE SOLUTION,  
Offshore Computing Limited,  
0707 44447  
BUSIFILE,  
Ormbeta Software, 0695 77043  
ORBETA SOFTWARE RANGE,  
Ormbeta Software, 0695 77043  
OPTIMUM,  
Professional Software Services,  
021-445 1039  
RESCUE,  
Qudos Systems Ltd, 01-253 3998  
NOTEBOOK,  
Raven Computers, 0274 309386  
TOMORROW'S OFFICE,  
TOMORROW'S OFFICE NETWORKING,  
TOMORROW'S OFFICE MULTI-FILE,  
SoSoft Ltd, 0202 735656  
SUPERFILE,  
Southdata Limited, 01-727 7564  
THE ADMINISTRATOR,  
Systematics Int Micro Sys Ltd,  
0440 61121  
KNOWLEDGE MAN,  
Tamsys Ltd, 07535 56747  
MDBS III,  
Tamsys Ltd, 07535 56747  
AQUILA EAGLE,  
The Data Processing Company Ltd,  
0303 41618

## EXPORT

ATLESS,  
B & D Computing Ltd, 0793 762449

## FILE TRANSFER

INTERCOMP,  
MCP Microsystems, 051-426 4178  
PET TO SIRIUS LINK,  
Robox (Office Equipment) Ltd,  
041-221 8413

## FINANCIAL PLANNING

FINAL,  
Datagro Ltd, 0628 20042  
VIPLAN,  
DMS Limited, 025 428419  
EASYSALC,  
Pearl Computers Ltd, 05432 22976  
FINANCIAL MODELLING,  
SMB Computer Services Limited,  
0623 651651  
SYSTEMATICS FINANCIAL  
PLANNING,  
Systematics Int Micro Sys Ltd,  
0440 61121

## FIXED ASSETS

BOS FIXED ASSETS,  
MicroProducts Software Ltd,  
01-831 8811  
FIXED ASSETS & PLANT REGISTER,  
Rowan Business Services Ltd,  
0482 860778  
FIXED ASSETS INC. C.C.A.,  
SMB Computer Services Limited,  
0623 651651

## FREIGHT FORWARDING

IMPEX,  
Vixon Computer Systems, 0472 58561

## GAMES

SOME GAMES FOR THINKERS,  
Fairs Ltd, 0632 617889  
ADVENTURE: ISLAND OF ARTMAN,  
KM-OTHELLO, MAZE-RUNNER,  
Kuma Computers Ltd, 07357 4335

AIR-RAID,  
R.J.L. Software Ltd, 0962 60738

## GOLF

BARON GOLF,  
Baron Systems, 0532 677736

## GRAPHICS

DESIGN-86,  
Blue Water Computer Services,  
01-731 0476  
GINO, TEKTRONIX 4010 EMULATION,  
Carrington Computer Consultants,  
01-247 8855  
CHARTMAKER,  
Computer Design, 01-609 1878  
PRIMA GRAPH,  
Desktop Services, 02812 3854  
MICRO SUPERGRAPH,  
Georgetown Computer Services,  
0235 817927  
GENERAL PLOTTING PACKAGE,  
Hydrotechnica, 0743 64939  
3-D SURFACE PLOTTER,  
GRAPHICS EDITOR,  
Magus Computer Systems Ltd,  
0225 60965  
MICROCHART,  
Praxis Business Systems, 0892 42267  
DOODLE,  
Triplex Ltd, 01-546 9670

## HARDWARE

SIRIUS-80 CARD,  
Small Systems Engineering Ltd,  
01-328 7145

## HARDWARE

INTERFACES  
MICROCACHE, SILICON DISK,  
Microcosm Research Ltd,  
01-226 9092

## HOTELS

HOTELIER,  
Rural Computer Systems, 0248 353782  
CHECK IN,  
AEC Business Systems, 0732 864829

## INCOMPLETE RECORDS

IRIS INCOMPLETE RECORDS  
SYSTEM,  
Transaction Technology, 07535 56789

## INSURANCE

CLASSIC POINT OF SALE UTILITY,  
Adam Hunter Associates,  
0993 830976  
PET TO SIRIUS LINK,  
Fairs Ltd, 0632 617889  
SILICON SALES MANAGER,  
Adam Hunter Associates,  
0993 830976  
POLICY MASTER,  
CSA Micro Systems, 0753 885389  
INSURANCE MANAGER,  
Fairs Ltd, 0632 617889  
THE PROSPECT,  
Imago Computers Ltd, 0272 213405  
INSURANCE BROKERS EXECUTIVE  
SYSTEM,  
Premium Broker Systems Ltd,  
0527 46867  
WASP INSURANCE BROKERS  
SYSTEM,  
Wasp Software, 01-684 7979

## INVESTMENT

FINANCIAL PORTFOLIO  
MANAGEMENT,  
Computer Design, 01-609 1878

## INVOICING

IBS-F ORDER ENTRY AND INVOICE,  
Graftcom Systems Ltd, 01-385 9422  
SALESKEEPER,  
Manco Softwares, 0624 832891  
MICROLEDGERS INVOICING,  
Mercator Computer Systems Ltd,  
0272 731079  
POS-IS, POS-PI,  
Micro Software Services,  
0384 288812  
BOS INVOICING,  
MicroProducts Software Ltd,  
01-831 8811

BUSY SALES INVOICING,  
Midland Acc & Comp Services Ltd,  
03272 71759

EXECUTIVE SALES INVOICING,  
Omicron Design Ltd, 0784 31809  
SALES/PRODUCT INVOICING,  
Ormbeta Software, 0695 77043  
PEGASUS INVOICING,  
Pegasus Software Ltd, 0536 522822  
SATELLITE INVOICING SYSTEM,  
Satellite Software, 0622 45697  
EASY ORDER ENTRY & INVOICING,  
Scorpion Computing Ltd,  
025126 3706  
INVOICING & SALES ANALYSIS,  
SMB Computer Services Limited,  
0623 651651  
INVOICING,  
Systematics Int Micro Sys Ltd,  
0440 61121

## LEDGERS

INTEGRATED ACCOUNT SYSTEM,  
Anagram Systems, 0403 59551  
ASTROLABE LEDGERS,  
Astral & Chambers Ltd, 0279 725812  
EXACT ACCOUNTING,  
Exact Business Systems Ltd,  
0743 241371  
FARMFAX MANAGEMENT ACCOUNTS,  
Farmfax Services, 0730 66123  
MICROLEDGERS-INTEGRATED  
ACCOUNTS,  
Mercator Computer Systems Ltd,  
0272 731079

SATELLITE NOMINAL LEDGER,  
Satellite Software, 0622 45697

EASY NOMINAL LEDGER,  
Scorpion Computing Ltd,  
025126 3706

## LEDGERS PURCHASE

EXACT PURCHASE & NOMINAL,  
Exact Business Systems Ltd,  
0743 241371  
IBS-F COMPANY PURCHASE  
SYSTEM,  
Graftcom Systems Ltd, 01-385 9422  
MICROLEDGERS—PURCHASE  
LEDGER,  
Mercator Computer Systems Ltd,  
0272 731079  
POS-PL,  
Micro Software Services,  
0384 288812  
BOS PURCHASE LEDGER,  
MicroProducts Software Ltd,  
01-831 8811  
BUSY PURCHASE LEDGER,  
Midland Acc & Comp Services Ltd,  
03272 71759  
EXECUTIVE PURCHASE LEDGER,  
Omicron Design Ltd, 0784 31809  
ORBETA PURCHASE LEDGER,  
Ormbeta Software, 0695 77043  
PEGASUS PURCHASE LEDGER,  
Pegasus Software Ltd, 0536 522822  
SATELLITE PURCHASE LEDGER,  
Satellite Software, 0622 45697

## EASY PURCHASE LEDGER

Scorpion Computing Ltd,  
025126 3706  
SYSTEMATICS PURCHASE LEDGER,  
Systematics Int Micro Sys Ltd,  
0440 61121

## LEDGER SALES

EXACT SALES LEDGER,  
Exact Business Systems Ltd,  
0743 241371  
IBS-F COMPANY SALES SYSTEM,  
Graftcom Systems Ltd, 01-385 9422  
MICROLEDGERS—SALES LEDGER,  
Mercator Computer Systems Ltd,  
0272 731079  
POS-SI,  
Micro Software Services, 0384 28881  
BOS SALES LEDGER,  
MicroProducts Software Ltd,  
01-831 8811  
BUSY SALES LEDGER,  
Midland Acc & Comp Services Ltd,  
03272 71759  
EXECUTIVE SALES LEDGER,  
Omicron Design Ltd, 0784 31809  
SATELLITE SALES LEDGER,  
Satellite Software, 0622 45697  
EASY SALES LEDGER,  
Scorpion Computing Ltd,  
025126 3706  
SYSTEMATICS SALES LEDGER,  
Systematics Int Micro Sys Ltd,  
0440 61121

## LEGAL

SERIATIM LEGAL ACCOUNTING,  
Chancery Data Ltd, 0474 814929  
LAWPAK,  
Solicitor Systems Ltd, 01-658 3937  
SUMMLAW (SOLICITORS  
ACCOUNTING),  
Sumlock Bondain Ltd, 01-250 0505  
WASP LEGAL ACCOUNTING & TIME  
RECORDING,  
Wasp Software, 01-684 7979

## MAILING

IBS-F NAME AND ADDRESS,  
Graftcom Systems Ltd, 01-385 9422  
EASYMAIL,  
Pearl Computers Ltd, 05432 22976  
MAILMASS,  
Vision Associates Ltd, 06284 75606

## MANUFACTURING

TAPEMASTER,  
Cambridge Numerical Control,  
0480 68639

# Have we got a p

IBM  
Micro Computer Systems,  
2 26678  
CAM,  
Aided Engineering Ltd,  
2 4041  
FACTURING PARAMETERISED

Key Comp Aided Engineering,  
423704  
PLOT, PATHTRACE, PATHTURN,  
Trace Ltd, 03727 42444

**MARKETING**  
MA—MARKETING ANALYSIS,  
Map Services, 02812 3854  
P—MARKET SURVEY ANALYSIS,  
icator Computer Systems Ltd,  
2 731079

**MEDICAL**  
ROMED ENDOSCOPY,  
ical Systems Ltd, 0494 361812

**MOTOR**  
VICE STATION,  
on File Software, 0608 41197  
M.T. VEHICLE REGISTER,  
cellos Ltd, 0533 541574  
TRONIC SALES & SERVICE,  
er-Parraat Group, 01-644 4355  
AS MOTOR QUOTES,  
pendent Systems Ltd,  
4 214993  
RENT,  
on Associates Ltd, 06284 75606

**PERSONNEL**  
THE PERSONNEL ASSISTANT,  
Missing Link Software, 01-349 4711

**PHARMACY**  
DRUGMASTER,  
Talkdata Ltd, 01-836 3230  
PLASMA,  
Vixon Computer Systems,  
0472 58561

**PRINTING**  
FANCY FONT,  
PCML Limited, 0372 67282  
CAXTON PRINT ESTIMATING  
SYSTEM,  
Printers Ass Business Systems,  
07535 56691  
PRO-PRINT,  
VHA Computer Services,  
0532 732442  
WASP PRINTERS COSTING SYSTEM,  
Wasp Software, 01-684 7979  
WASP PRINTERS ESTIMATING,  
Wasp Software, 01-684 7979

**PRODUCTION**  
BILL OF MATERIALS,  
Action File Software, 0608 41197  
COMAC ASSET REGISTER, COMAC  
CONDITION BASE, COMAC DEFECT  
ANALYSIS, COMAC III MAINTENANCE  
MANAGEMENT, COMAC PLANT  
HISTORY, COMAC RESOURCES,  
COMAC WORK IN PROGRESS,  
COMAC Systems plc, 0276 76118

DISKZAP-DISK UTILITY,  
BusiSoft, 01-381 4337  
COPYLOCK,  
Export Software International,  
031-556 3266  
GRAPHIX, JCODE, SIRIUS/PRINTER  
SCREEN DUMP,  
J. R. Ward Computers Ltd,  
0908 562850  
BOS AUTOCLERK—REPORT  
GENERATOR, BOS MICROBOL APF  
UTILITIES,  
MicroProducts Software Ltd,  
01-831 8811  
BUSY REPORT GENERATOR,  
Midland Acc & Comp Services Ltd,  
03272 71759  
MICRO-CIPHER,  
MLH Technology, 0606 891146  
IOSUBS,  
R.J.L. Software Ltd, 0962 60738  
PANEL,  
Roundhill Computer Systems Ltd,  
0672 54675  
AUTOCODE FOR dBASE II,  
Stemmos Ltd, 01-602 6242

**PROGRAMMING AIDS**  
VUWRITER—TEXT EDITOR,  
Vuman Ltd, 061-273 5315

**PROGRAMMING LANGUAGE**  
POLYFORTH,  
Computer Solutions Ltd, 09328 65292

**PROPERTY**  
ABMS (SZYGG) PROPERTY  
MANAGEMENT,  
ABMS Computer Services,  
0273 24953  
HOUSING ASSOCIATION SYSTEM,  
B & D Computing Ltd, 0793 762449  
DISCOVERY ESTATE MANAGEMENT,  
Mimex Business Systems,  
01-387 4599

**PURCHASE ORDERS**  
EASY PURCHASE ORDER TRACKING,  
Scorpion Computing Ltd,  
025126 3706  
PURCHASE ORDERING,  
SMB Computer Services Limited,  
0623 651651

**QUANTITY SURVEYOR**  
BOS QUANTITY SURVEYOR,  
Barcellos Ltd, 0533 541574  
SURVEYOR,  
Computer Design, 01-609 1878

**RETAIL**  
DATAROUND,  
B & D Computing Ltd, 0793 762449  
BAR STOCK CONTROL,  
Trionic Software Ltd, 0482 867824  
WESTERN RETAIL COUNTER,  
Western Computers Ltd, 0253 404676

**SALES LEDGER**  
ORMBETA SALES LEDGER,  
Ormbeta Software,  
0695 77043

ORMBETA STOCK CONTROL SYSTEM,  
Ormbeta Software, 0695 77043  
PEGASUS STOCK CONTROL,  
Pegasus Software Ltd, 0536 522822  
BARSTOCK,  
Rural Computer Systems,  
0248 353782  
SATELLITE STOCK SYSTEM,  
Satellite Software, 0622 45697  
EASY STOCK CONTROL,  
Scorpion Computing Ltd,  
025126 3706  
MBSS BAR STOCKTAKING SYSTEM,  
Silicon Chip Computers Ltd,  
0305 787592  
SYSTEMATICS STOCK CONTROL,  
Systematics Int Micro Sys Ltd,  
0440 61121  
STOCK CONTROL,  
SMB Computer Services Ltd,  
0623 651651

**TECHNICAL**  
MICROLINK IEEE-488 PROGRAM,  
Biodata Ltd,  
061-236 1283  
DIGITAL ANALYSIS LIBRARY,  
Computer Design, 01-609 1878  
AQUIFER TEST,  
Hydrotechnica, 0743 64939

**TELEX**  
MITELEX,  
Interdata (Computer Systems) Ltd,  
01-761 4135

**TRAVEL**  
TRAVEL PLAN II, TRAVEL PLAN I,  
Western Computers Ltd, 0253 404676

**VIDEO**  
VIDEO HIRE,  
Action File Software, 0608 41197  
VIDEOSTAR,  
Aphros Software & Computers Ltd,  
0843 294699  
M.C. VIDEO STAR,  
Georgetown Computer Services,  
0235 817927

**WHOLESALE**  
THE VINTNER,  
Philcomp Systems Ltd, 02403 22339

**WINDOWS**  
GLAZE,  
Capricorn Computer Systems,  
0905 26678  
SEALED UNITS, WINDOWS AND  
DOORS,  
Honeywood Computing Ltd,  
0935 71117  
WINDOWMAKER,  
Sixteen Bit Software Ltd,  
01-399 7156

**WORD PROCESSING**  
BUSIPOST—OFFICE MANAGEMENT,  
SPELLBINDER,  
BusiSoft, 01-381 4337  
WORDCRAFT,  
Dataview Wordcraft Ltd,  
0206 869414

# Program for you?

**NEWSAGENTS**  
WSHOP,  
on File Software, 0608 41197  
WSSHOP,  
on Software, 0934 32685  
NEWS SYSTEM,  
Microsystems, 0525 379229  
**OFFICE MANAGER**  
NDER,  
ri Computers Ltd, 05432 22976  
**ORDER ENTRY**  
DER ENTRY,  
B Computer Services Ltd,  
3 651651

**PAYROLL**  
ROLL SYSTEMS,  
on File Software, 0608 41197  
CT PAYROLL,  
ct Business Systems Ltd,  
3 241371  
S-F PAYROLL,  
ffcom Systems Ltd, 01-385 9422  
ROLL BUREAU SYSTEM,  
Business Info Systems Ltd,  
860 7123  
US,  
x Datalog Limited, 0642 781193  
PAYROLL,  
roProducts Software Ltd,  
31 8811  
CY COMPREHENSIVE PAYROLL,  
SY GROSS TO NET PAYROLL,  
land Acc & Comp Services Ltd,  
72 71759  
MBETA PAYROLL,  
beta Software,  
5 77043  
ASUS PAYROLL,  
asus Software Ltd, 0536 522822  
E PAYROLL,  
esoft Ltd, 0632 761669  
ROLL WEEKLY & MONTHLY,  
B Computer Services Ltd,  
3 651651  
TPAY,  
t On Software, 0934 32685  
TEMATICS PAYROLL,  
ematics Int Micro Sys Ltd,  
0 61121

**PENSIONS**  
SYS86—PENSION SOFTWARE,  
of London Computer Services,  
31 9566  
MICRO-PENSION SYSTEM,  
ro-Pension, 01-394 2049

DEWTEC FOUNDRY PRODUCTION  
CONTROL,  
Dewtec Computer Systems,  
021-643 8003  
PILOT,  
Diskwise Ltd, 0752 267000  
MICROSS MATERIAL CONTROL  
SYSTEM, MICROSS PRODUCTION  
CONTROL,  
Kewill Systems Ltd, 0932 248328  
TIMESTUDY—  
WORK MEASUREMENT,  
Mercator Computer Systems Ltd,  
0272 731079  
EASY PARTS EXPLOSION,  
Scorpion Computing Ltd, 025126 3706  
PRODUCTION MANAGEMENT,  
SMB Computer Services Limited,  
0623 651651  
PRODUCTION CONTROL,  
Stephen Hartley Computing Ltd,  
0203 24444  
TEL-TIME TIME STUDY SYSTEM,  
Telford Management Services,  
0902 771466  
TEL-SAMPLING ACTIVITY SAMPLING,  
Telford Management Services,  
0902 771466  
MULTI-LEVEL ASSEMBLIES,  
Top Business Systems Ltd,  
06076 729324  
PRODUCTION INTERACTIVITY  
MATERIAL CONTROL,  
PRODUCTION INTERACTIVITY  
PRODUCTION CONTROL,  
PRODUCTION SCHEDULING,  
Turnkey Comp Aided Engineering,  
0272 423704  
Q-COST IV, STAT-PACK,  
WM Management Services, 0926 28901

**PROFESSIONAL**  
TRS—TIME RECORDING SYSTEM,  
Graffcom Systems Ltd, 01-385 9422  
IBIS TIME RECORDING,  
IBIS Business Info Systems Ltd,  
061-860 7123  
MODTIME—MODULE 1,  
MODTIME—MODULE 2,  
MODTIME—MODULE 3  
Modray Ltd, 041-339 1203  
TIME & OFFICE COSTING,  
Trionic Software Ltd, 0482 867824

**PROGRAMMING AIDS**  
ASHSCREEN,  
Ashley's Computer Bureau,  
0902 21941

KUMA FORTH,  
Kuma Computers Ltd, 07357 4335  
OPTIMISING—C86 COMPILER,  
MCP Microsystems, 051-426 4178  
BOS MICROBOL,  
MicroProducts Software Ltd,  
01-831 8811

**PROJECTS**  
PLANTRAC,  
Computerline Limited, 0932 55757  
PERTMASTER,  
Abtex Software Ltd, 0274 734838  
PCC,  
Hevacomp Ltd, 0742 661003  
PROJECT ANAGRAM PROGRAM,  
Imago Computers Ltd, 0272 213405  
MICRO PLANNER,  
Micro Planning Services,  
0272 509417  
PROJECT COST CONTROL SYSTEM,  
The Consultancy Consortium,  
04895 82103  
PROJECTS CONTROL,  
Turnkey Comp Aided Engineering,  
0272 423704

**STATISTICS**  
REGRESSION ANALYSIS,  
Hydrotechnica, 0743 64939  
SAM-86,  
International Software, 07073 26633  
STATPAK,  
Raven Computers, 0274 309386

**STOCK**  
EXACT STOCK & INVOICING,  
Exact Business Systems Ltd,  
0743 241371  
ISBS-F STOCK CONTROL,  
Graffcom Systems Ltd, 01-385 9422  
STOREKEEPER,  
Manco Softwares, 0624 832891  
POS-SL,  
Micro Software Services, 0384 288812  
BOS INVENTORY CONTROL,  
MicroProducts Software Ltd,  
01-831 8811  
BUSY STOCK & INVOICING,  
Midland Acc & Comp Services Ltd,  
03272 71759  
EXECUTIVE STOCK CONTROL,  
Omicron Design Ltd, 0784 31809

**TRAINING**  
TOUCH 'N' GO,  
Caxton Software Ltd, 01-379 6502  
EASY L CITS,  
Davy Computing Ltd, 0742 71201  
IANKEY CRASH COURSE,  
Iansyst Ltd, 01-607 5844  
SNOWBALL KEYBOARD TRAINING,  
MicroGuide Limited, 0602 585282  
SNOWBALL WORDSTAR TRAINING  
TO RS,  
MicroGuide Limited, 0602 585282

**TRANSPORT**  
VEHICLE FLEET CONTROL,  
Capricorn Computer Systems,  
0905 26678  
COACH OPERATORS,  
Distinctive Systems Ltd, 0937 845735  
TRANSPORT,  
Halcrow Fox & Associates, 01-741 8421  
AUTO-FOS CHART READER, FLEET  
MGMT ANALYSIS SYSTEM,  
QUICK-FOS CHART READER,  
Lucas Kienzle Instruments Ltd,  
021-328 5533

OMAN, WP2020,  
Graffcom Systems Limited,  
01-385 9422  
BOS AUTOWRITER,  
MicroProducts Software Ltd,  
01-831 8811  
TRENDTEXT/2,  
Microtrend U.K.,  
0423 711878  
PRO-FORMER, MICROTYPE,  
TEXTCHECKER,  
MLH Technology, 0606 891146  
EASYWORD,  
Pearl Computers Ltd, 05432 22976  
BOOK MACHINE,  
Prefis Ltd,  
01-904 1309  
WORD PROCESSING  
Systematics Int Micro Sys Ltd,  
0440 61121  
SILICON OFFICE,  
The Bristol Software Factory,  
0272 735022  
BRITISH SPELLGUARD,  
Vision Associates Ltd, 06284 75606



Before you buy a computer, make sure you can get the software you need. This advertisement shows recognised software programs which can run on ACT Apricot or Sirius 16-bit business micros. For details, ring the publishers on the phone numbers listed. For the latest packages now available, ring Freefone Apricot. There isn't a bigger published range in Britain.

# HOW TO IMPROVE YOUR IBM PC AND XT



## AMERICA'S MOST POPULAR ENHANCEMENTS FOR IBM PC AND XT

### MAKE YOUR COMPUTER WORK HARDER FOR YOU

If you have purchased the IBM PC or XT then you are the owner of a very fine computer.

But like everything else it can be improved to work harder for you. It took a company like Qubie' to do it.

Qubie' can supply either the SixShooter or the QPlus II to up-grade your IBM PC or XT. Both are engineered to match the IBM quality stamp.

While only occupying one slot in your computer these

two boards boost your PC or XT's capability with a selection of essential features.

### SIXSHOOTER - IDEAL FOR PC OR XT

For most customers the SixShooter offers all that you require from a multifunction board. 64K of Ram (socketed up to 384K), a serial port, a parallel port, automatic clock/calendar with battery back up are all standard. An IBM compatible games port adaptor is optional.

### QPLUS II - MORE OPTIONS

Corporate customers and those with special needs will appreciate the ability of the Q plus II. Ram is expandable from 64K all the way to 512K. Add two serial ports, a parallel port clock/calendar and a games port to give 4 I/O connections from one slot.

IBM is the registered trademark of International Business Machines.

### QUBIE' PAK SOFTWARE SPEEDS THINGS UP

Free with each board are the custom-made Qubie' drive™ and Qubie' spool™ programmes.

Qubie' drive™ disk emulation software allows you to create up to three "electronic disk drives" in memory which access your programmes at the speed of RAM memory.

Qubie' spool™ is a

programme which allows you to assign a portion of memory to act as a print spooler.

### QUALITY BACKED BY WARRANTY

Both boards are backed by our one year parts and labour warranty.

Visit your local dealer and pick up a brochure with the full details. If he does not have the information contact us.

It's the best way to improve your PC.

# QUBIE'

---

## DISTRIBUTING LTD.

20 QUBIE' - IMPROVING WHERE OTHERS STOP.

Qubie' Distributing Ltd.  
Tempo House, 15 Falcon Road,  
London SW11.  
(01) 223-4569/7662.  
Telex: 8956035. G.

Qubie' Distributing Ltd.  
4809 Calle Alto, Camarillo,  
CA 93010, USA.  
805-987-9741.

● Circle No. 111

# North Star's Dimension

AFTER SIX YEARS of successfully making single-user micros like the Horizon and the Advantage — reviewed here in April 1979 and June 1982 respectively — North Star has launched a networking system which aims to replace two or more IBM PCs.

The new system, called the Dimension, comprises an 80186-based file server with 256K of cache memory, one floppy and a 15Mbyte or 30Mbyte hard disc, plus two 8088-based work stations. The file server has a 13-slot IBM-compatible bus, which allows up to 10 more work stations to be added.

The advantages are the built-in electronic mail and shared access to discs, printers and

other peripherals. And as each user has a dedicated 8088-2 board and 128K of RAM, performance does not degrade as with multi-user systems.

The main disadvantage is that the system is too expensive for a single user, so the minimum configuration includes two work stations. It costs £5,375 plus VAT, which is cheaper than buying an IBM PC/XT, an IBM PC and a network.

Cost savings become more

significant when further work stations are added at a cost of £1,275 plus VAT each. A 12-user system is claimed to be 30 percent cheaper than a network of IBM PCs.

North Star is a Californian Company with a manufacturing subsidiary in Cork in Ireland — just like Apple. Contact North Star Computers, Alton, Kitsbury Road, Berkhamsted, Hertfordshire HP4 1BR. Tel: (04427) 75577.

## Pete & Pam imports

10-Base is a new database from Fox Research of Dayton, Ohio. It is based on the so-called "fourth-generation" English-like language Sequel, SQL, used on IBM mainframes. The database interfaces with other products via ASCII and Dif file formats. A 10-Net LAN version is also available. At least 128K is required by 10-Base. It costs £415 plus VAT.

Prokey and Smartkey II are keyboard utilities. Prokey provides the facility to redefine keys or add macros, so one key or key combination calls up a whole string of commands. It costs £80 plus VAT. Smartkey II seems to be the same thing with knobs on. More than 3,000 characters can be assigned to a single key, while the Supershift function allows each key to have up to four meanings. Smartkey II costs £69 plus VAT.

Multigraph is a new card from Profit systems, designed to replace both the monochrome screen driver and the IBM colour-graphics adaptor. Thus it allows programs written for use with a colour monitor to be run on the green screen. An extra facility is a 720- by 350-pixel high-resolution mode — 90 columns by 40 lines — which is compatible with Lotus 1-2-3. Multigraph costs £375 plus VAT.

Sideways from Funk Software of Cambridge, Mass., just turns your spreadsheet at right-angles during printing. It works with the major spreadsheet programs and most word processors. It costs £49.49 plus VAT.

Set-FX from Softstyle of Honolulu is also a printer utility. It provides a number of utilities for exploiting the capabilities of the Epson FX printers. It costs £45 plus VAT.

● Pete & Pam Computers is at New Hall Hey Road, Rossendale, Lancashire BB4 6JG. Telephone: (0706) 212321/227011.

## What's in store

THE MODEL 600 is a store computer, aimed at the retail trade.

With the Retail Comm interface, the 600 communicates with DTS-500 and DTS-2100 point-of-sale terminals. A food-service system is also available; and yes, it does have menu-driven software.

Contact National Semiconductor Datachecker/DTS, Belvue Road, Northolt, Middlesex UB5 5HY. Tel: 01-841 6141.

Smaller shops and cafés could decide on a Rapi-Serv system instead. It consists of an IBM PCjr modified into a point-of-sale terminal. It comes complete with monitor, receipt printer and cash drawer. Prices for the Rapi-Serv start at \$3,900.

Contact Application Innovations, 1550 Old W. Henderson Road, Columbus, Ohio 43220. Telephone: (U.S. area code 614) 451-7835.

## PC to GPIB

AN IEEE-4888 interface is now available on a short card for the IBM PC or XT. Software support includes operation under PC-DOS 2, a diagnostic program and a stand-alone driver for other operating systems. The price is quoted as "from £439", which includes a 259-page manual.

Contact Amplicon Elec-

tronics, Richmond Road, Brighton, Sussex BN2 2RL. Telephone: (0273) 608331.

## Venix/86

IBM may promise Unix as PC/IX, but Cambridge Micro Computers can now deliver Unix as Venix/86. CMC already supplies this licensed implementation of Unix from Venturcom on the Codata

68000 and DEC minicomputers.

Venix/86 includes the Office Menu Tool to assist with shell construction plus UUCP and CU for communications. Hardware requirement is an IBM PC XT with 128K minimum for multi-tasking operation, or 256K for multi-user operation.

Contact Cambridge Micro Computers, Science Park, Milton Road, Cambridge CB4 4BN. Telephone: (0223) 314666.

Corporate Data Sciences 的新式电子计算机终端器  
 和有关软件提供了第一-部中文; 程序系统其构造简单且能  
 精确地理解并能打印出个汉字  
 使用者通过程序详细说明了在荧光屏上每个按钮  
 都标有基本结构中打出该字的那其他组成部分的  
 总数及汉语拼音功能能在电子计算机的记忆系统中找出  
 该字  
 实际上此技术可用与任何组合使用所选择的程序当  
 语; 程序工作时荧光屏上能显示出操作者的选择  
 对的用汉字的国家我们还将提供台式电子计算机  
 它具有最少比" 大结的功能它伴随着我们的电子计算  
 机终端器 起出  
 请写或电 182 Santa Clara  
 H. P. 182  
 电话: 916 938 7242 Telex: 7253 AOS OITEC  
 电报  
 电报名称

The Video Scroller Terminal is an add-on unit for the IBM PC XT providing word processing in Chinese. All 7,310 Chinese characters are stored on the XT's hard disc, and are accessed via a digitised pad. The Video Scroller has a 17in. screen with a resolution of 1,024 by 1,024 pixels, and can draw at a rate of 39.6 million pixels per second, so non-Chinese writers might also find exciting uses for it. The U.S. price is \$5,995, including VText software. Contact Corporate Data Sciences, Suite 102, 3560 Mission College Blvd, (U.S. area code 408) 980-9747.

## Olivetti, again

PRICES have now been announced on the new IBM PC-compatible Olivetti M-24 desktop micros. They are low, and are backed by a very aggressive dealer discount structure. The M-24, with 128K of RAM, one floppy-disc drive, monochrome graphics display, serial and printer ports plus MS-DOS costs £1,595 plus VAT.

A twin-floppy model with 256K of RAM, as reviewed in *Practical Computing*, May 1984 costs £2,078 plus VAT. Numerous other options are available as detailed in Olivetti's price list.

Since we reviewed the prototype M-24 we have received an updated ROM and a new DOS disc. The M-24 now runs all our IBM software, with the exception of IBM's DOS 2 diagnostics disc.

Contact British Olivetti Ltd,

(continued on page 24)

# Consider our s professional

If you ever have to bring work home from the office you can now tackle it in a fraction of the time, thanks to our range of software.

With these inexpensive new programs you can turn a Commodore 64 personal computer into a fully-fledged business tool to improve the smooth operation of your calculations, filing and ordering or information storage.

All the programs are easy to learn and use, and all cost less than £50.

There's no more cost effective way to turn your home computer to practical use.

## Practicalc 64. The complete spreadsheet for Commodore 64.

With this program your cashflow will do just that.

Flow.

Practicalc 64 accepts both numerical and alphabetical entries and allows you to work out sales forecasts, long-term budgets, sales models or long term cash plans.

All in a fraction of the time they normally take.

Practicalc 64 has 2000 cells, more than 20 mathematical functions, (including logarithms and roots), can insert or delete rows or columns, can 'SORT' information alpha-numerically and has a 'SEEK' function to search for specific information.

It can even display the information in graph form to allow a quick visual appraisal of the situation. Disc £44.50 (Tape £39.95).

Over 20 mathematical functions.  
Column width up to 38 characters  
2000 cells.  
Graph function.

MONTHLY	YEARLY	YEARLY %
INCOME	10000.00	10000.00
EXPENSE	4000.00	8000.00
PROFIT	6000.00	60.00%
TOTAL	10000.00	100.00%
MONTHLY	1000.00	1000.00
EXPENSE	400.00	400.00
PROFIT	600.00	60.00%
TOTAL	1000.00	100.00%
DISPOSABLE	4000.00	11000.00

Sorts files by number or letter in less than one second. Fully compatible with Practicalc 64.

**FILE MENU**  
VIEW DIRECTORY  
DIRECT FILE MAINTENANCE  
BATCH ENTRY  
GAIL LABELS  
REPORT WRITER  
CREATE SEQ FILE  
LOAD FROM SEQ FILE  
ALPHABETICAL REORDERING  
FILE CALCULATIONS  
RETURN TO DISK MENU

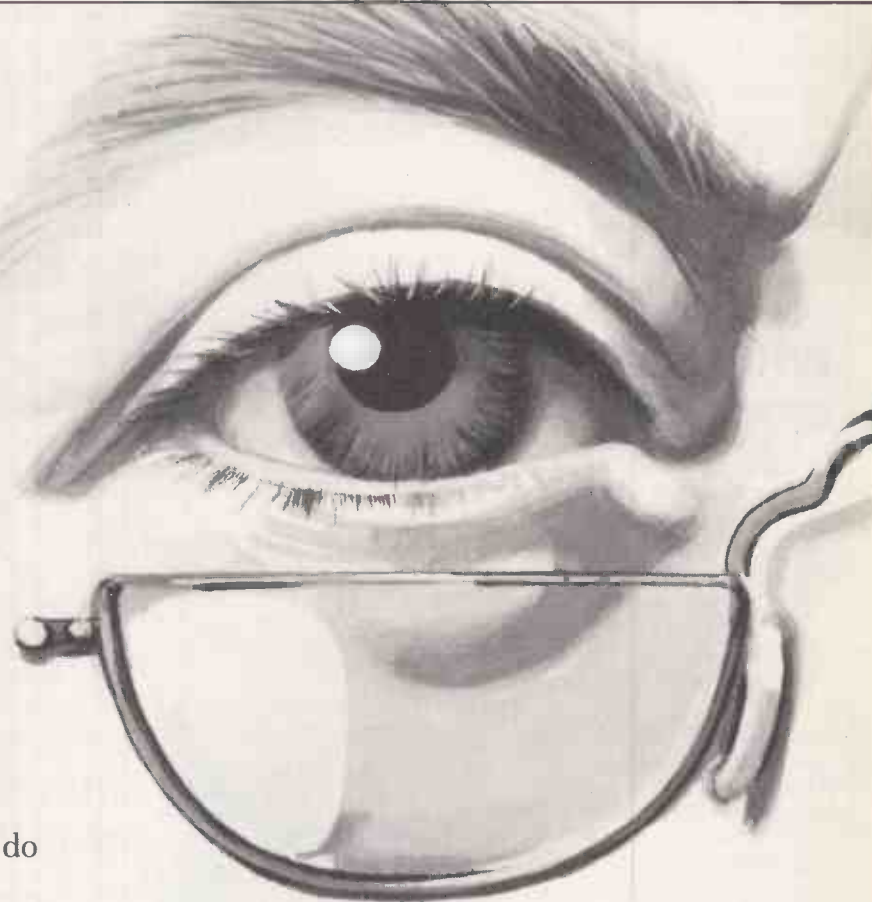

## Practifile 64. The database for Commodore 64.

Practifile means an end to bulky and time-consuming storage of files, client or patient information or names and addresses.

And it means you'll no longer have to spend minutes or hours searching through piles of paper for a specific piece of information.

Each file on the program is able to handle 3,800 record entries, and Practifile can sort the files it contains by number or letter in less than a second.

The system is so flexible that you can add, subtract, multiply or divide within individual files, which its use with a word-processing system means that you

# Software from a point of view.



location, stock, year-to-date sales, re-order date, minimum quantity, vendor, list price and other important facts.

From this information your personal computer, with the help of Inventory 64, will be able to collate and assess the major points of an efficient system and be able to present you with a complete and instantaneous view of current stock situations.

And ensure that stock control problems really are a thing of the past.

Pretty good value at just £29.95.

You'll find our superb range of Commodore 64 software for professional and business use in all good computer stores including selected branches of Boots, W.H. Smith, Menzies and Laskys.

If you'd like more information about our software or require any technical help fill in the coupon or phone us on 0473 462721.

can have instant 'hard-copies' in a matter of minutes.

While Practifile means instant access to mailing lists.

At just £44.50 you won't find a more versatile, flexible and professionally useful data-base.

## Inventory 64. The quick, reliable inventory system.

With its capacity of 650 items, Inventory 64 is ideal for the average small business, and means a vast improvement in the efficiency of good stock control.

All you have to do is to enter each item, followed by the information which the program will prompt.

That means things like part number, description,

Handles up to  
650 parts.  
The quick answer  
to stock control  
problems.

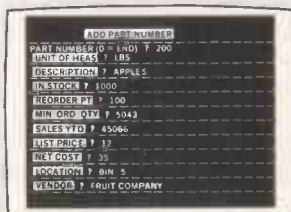

Name \_\_\_\_\_

Address \_\_\_\_\_  
\_\_\_\_\_  
\_\_\_\_\_

PC/84



# PRACTICORP

**IF YOU DO  
BUSINESS ABROAD  
YOU NEED TO THINK  
ABOUT**



Tick-Tack includes floppy discs, detailed users' guides, and an operating manual.

£150 incl. VAT

## A SOFTWARE PACKAGE TO REVOLUTIONIZE YOUR BUSINESS COMMUNICATIONS

**in ENGLISH · FRENCH  
GERMAN · SPANISH**  
Devised by David Sephton

the software that enables your business to communicate in a foreign language.

composes business letters in your language using a wide range of standard sentences which can be automatically converted into any of the languages shown above.

collates and edits letters, then prints them out using a standard word processing program.

is the instant correspondence kit for anyone in business.

Write or phone for your free leaflet to:

Polly Scott on (0279) 34622  
Longman Group, Longman House,  
Burnt Mill, Harlow, Essex CM20 2JE

**Longman**

**APPLE II/IIe/III  
SIRIUS  
IBM PC**

● Circle No. 113

(continued from page 21)

Olivetti House, 86 Upper Richmond Road, London SW15 2UR. Telephone: 01-785 6666.

## Welcom Superdos

WELCOM sells a 10-user Z-80 based system bought in from Integrated Business Computers of Chatsworth, California. It runs under Superdos.

Now a new version of Superdos has been launched for the IBM PC. It comes with a communications/RAM/clock card, and Welcom will also sell you a Tallgrass hard disc, if you should happen to want to hang 10 dumb terminals on the end of your PC.

Contact Welcom Business Systems, 17 Victoria Avenue, Harrogate, North Yorkshire HG1 5RD. Telephone: (0423) 60322.

## Santa Clara, Egham

SANTA CLARA SYSTEMS' low-cost intelligent terminal for the IBM PC, announced in our April issue, is now being distributed in the U.K. by Ferrari Software of Egham, Surrey. Other Santa Clara products also being handled are the PC Net low-cost local area network, a 6Mbyte 3.9in. hard disc and 3.9in. removable cartridge.

Contact Ferrari Software, Ferrari House, Station Road, Egham, Surrey TW20 9LB. Telephone: (0784) 38811.

## Integrated PC from Direct

THE DIRECT PC is a straightforward IBM PC look-alike with an 8088, 128K of RAM, two 360K half-height floppies, two serial ports, a Centronics parallel port and clock/calendar. It costs £2,335 plus VAT. An XT look-alike is also available, with 256K of RAM and a 10Mbyte hard disc, for £3,735.

What makes the Direct slightly different is that the

company can offer terminal emulation for IBM and Hewlett-Packard mainframes, with DEC emulation to follow.

Direct manufactures in Santa Clara, California. Contact Direct Technology in the U.K. by telephoning (0925) 814072.

## Rating IBM word processors

A NEW MONTHLY magazine has set itself the task of rating software for the IBM PC. For its first issue, January 1984, the *Software Digest Ratings Newsletter* spent \$100,000 and took two months to review word processors. The magazine gave each of 10 reviewers 30 word-processing packages, and asked for ratings in eight categories. They ranged from ease of start-up to value for money. Finally the programs were arranged in order and given from nought to five stars.

That sounds thorough, but it does not mean *Practical Computing* agrees with the results, which even the *Software Digest* describes as surprising.

The top four programs, receiving four stars each, were PFS:Write, Volkswriter Deluxe, Office Writer and Visiword Plus — none of which we have used, so we can hardly criticise.

However, the ratings of Multimate with three stars, Wordplus PC and Microsoft Word with one star each, and WordStar with no stars, hardly match our own findings. Nor would we have placed Spellbinder, Perfect Writer and Final word — again, no stars each — in places 27 to 29 of the 30 programs tested.

If it is any consolation to those who like these programs, WordStar and Wordplus-PC are two of the three best-selling programs on the IBM PC, according to *Softalk* magazine. PFS:Write is at number 15 in *Softalk's* top 30, and the other three four-star programs are nowhere.

The *Software Digest Ratings Newsletter* costs \$135 per year or \$14.95 per issue. Contact address is 1 Wynnewood Road, Wynnewood, Pa 19096, U.S.A.



# DASH-80

## SOFTWARE INCLUDED

CP/M 80<sup>1</sup>  
 CP/M utilities  
 System utilities  
 WORDSTAR<sup>2</sup>  
 CALCSTAR<sup>2</sup>  
 PERSONAL PEARL<sup>3</sup>  
 On line HELP file

## HARDWARE DESCRIPTION

6MHz Z80B processor  
 128k RAM  
 Ultra fast 'cache' disks  
 One/two 5 1/4" disk drives  
 Up to 1568k disk storage  
 Two RS232 serial ports  
 Parallel printer port



The DASH-80, designed and assembled in Great Britain to exploit the vast range of CP/M based application software, provides a processor performance that exceeds that of most current 16-bit systems and floppy disk access times as fast as those of many hard disks.

The DASH-80 comes complete with a selection of powerful software tools including:

- WORDSTAR, the world's most popular word processor software,
- CALCSTAR, wordstar compatible electronic spreadsheet,
- PERSONAL PEARL, a powerful data base application generator.

DASH-80 processor prices (Inclusive of software) start at — £1084.00 (RRP, excl VAT),  
 DASH-10 terminal shown above — £ 560.00 (RRP, excl VAT).

For further information on the system, and for details and listings of disk and processor benchmarks, telephone or write to the address shown below:

### PROCESSOR BENCHMARKS

	BM1	BM2	BM3	BM4	BM5	BM6	BM7	BM8
DASH-80	.73	2.4	6.6	6.5	7.0	12.7	20.2	34.3
IBM PC	1.2	4.8	11.7	12.2	13.4	23.3	37.4	30.0
APRICOT	1.5	4.8	10.4	10.8	12.2	22.8	35.5	34.0
SIRIUS	1.7	5.4	11.1	11.5	13.6	26.2	40.1	29.0

### DISK BENCHMARKS

	DBM1	DBM2	DBM3	DBM4	DBM5
DASH-80	0.6	4.3	4.2	3.8	3.7
IBM PC	3.8	21.2	20.8	12.7	10.4
APRICOT	3.0	9.5	14.0	8.0	7.5
SIRIUS	2.5	37.0	37.0	12.0	12.0

**aculab** LTD.

Unit A,  
 Station Approach,  
 Leighton Buzzard,  
 Beds. LU7 7LY

25

Trademarks: (1) Digital Research, (2) Micropro, (3) Relational Systems.

# A year ago software was nothing like

1984 marks the advent of the new age of database software. The kind of software that executives can really work with – to get the right information at the right time.

Your staff will really enjoy using DELTA. They'll be able to create their own records, for any one of a thousand myriad uses. Imagine having ALL the vital information about your business stored on disk – from contracts to car fleet records, club records to currency exchanges, customer records to course bookings. Data on file can be added to or amended in seconds, and files searched and sorted at lightning speed. You'll really be able to respond quickly and efficiently to changes in the business world, AND take positive action to maximise on whatever situation develops.

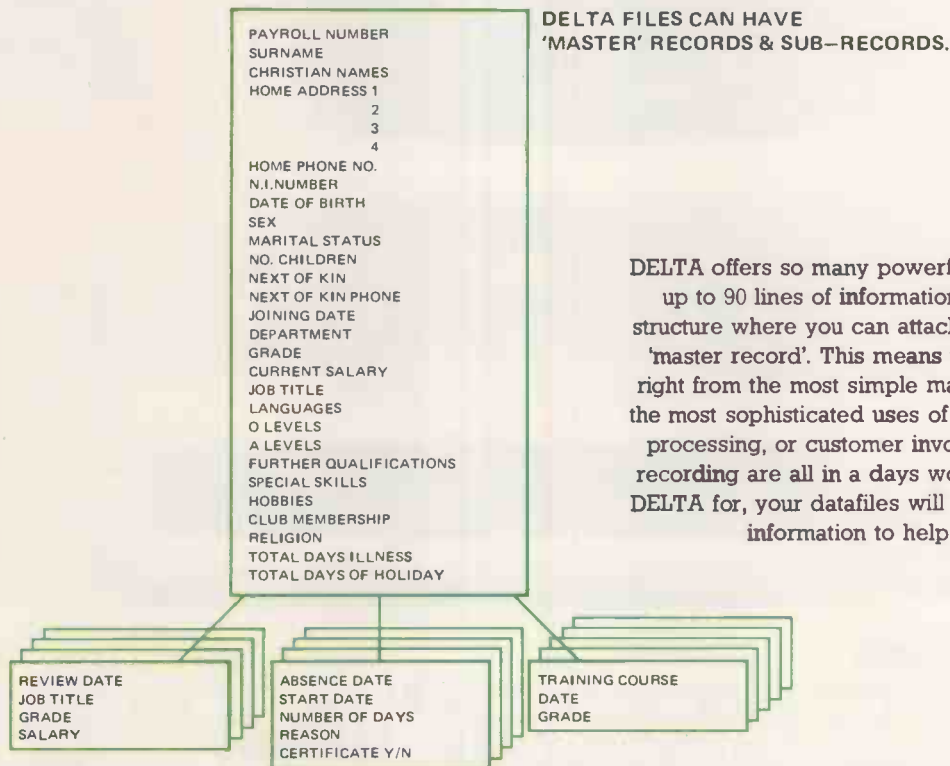

DELTA offers so many powerful functions. Each record can hold up to 90 lines of information, and DELTA has a special file structure where you can attach up to 32,000 sub-records to each 'master record'. This means that DELTA can grow with you – right from the most simple mailing or record system through to the most sophisticated uses of microcomputers. Stock with order processing, or customer invoicing, or personnel and absence recording are all in a days work for DELTA. Whatever you use DELTA for, your datafiles will become an endless source of vital information to help you run your business.

DELTA is available for most microcomputers with the PC DOS, MSDOS or CP/M operating systems, including the IBM PC, SIRIUS, APRICOT, DEC RAINBOW, HP 150, EPSON QX 10, XEROX, etc, etc. DELTA is available in 8 European languages and is also distributed by IBM, DEC and HP.

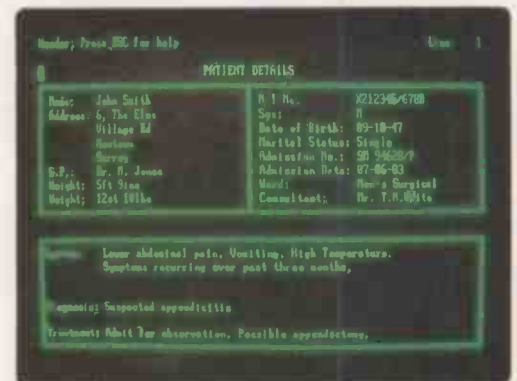

his..

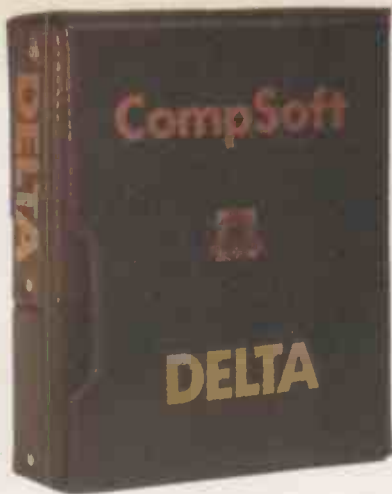

DELTA is truly user friendly. It is designed for busy executives and DP professionals who need to get the job done quickly. DELTA offers powerful sorting and selection capabilities, its own calculation program, PLUS its own report generator to print lists, reports, mailing labels and even personalised letters. DELTA also links with LOTUS 123, Multiplan, Wordstar, and Pegasus. It's the perfect way to make the most of your data.



DELTA PRINTS ALL TYPES OF REPORTS, LISTS, LABELS & PERSONALISED LETTERS.

Unlike any ordinary database, DELTA can be ready to use on the same day that it arrives on your desk. Simply use the question and answer routines to tell DELTA what you want to do - later on you can even write your own menu of options, and hand DELTA over as a complete 'dedicated' system for the job it has to do. DELTA is the modern way to store data - you can confidently regard DELTA as the most comprehensive and sophisticated database on the market today.



COMPSOFT HEADQUARTERS & TRAINING CENTRE.

If you haven't already looked at DELTA now is the time to do so. You can either see it at Compssoft's headquarters near Guildford, or we'll recommend the best local supplier in your area.

Training courses, a Users Club and 'Hotline' service provide a totally professional after-sales backup service

Ring us or return the clip coupon to receive a superb 12 page full colour guide to database software, and a technical summary of DELTA'S main functions. Or chat on the phone to one of our consultants about your own business application. Whatever you do, don't stay in the dark ages about database software - DELTA is your key to success.



Compssoft Limited, Hallams Court  
Shamley Green, Nr Guildford, Surrey  
England GU4 8QZ.  
Telephone: Guildford (0483) 898545  
Telex: 859210

Please send me further details

Company .....

Contact .....

Address .....

Tel .....



# Get the Connection?



## ACT Pulsar 'File Transfer'

It's easy to get the impression that the differences between micros are there to tie you down. How do you upgrade from 8-bit Apple to today's 16-bit micros, or copy files between different 16-bit machines, without hours or even days of laborious data re-entry – and all the dangers that entails?

The answer is Pulsar File Transfer. It puts Apple, Sirius, Apricot and IBM straight onto the same wavelength, transferring file type, text, binary or graphic information directly at up to 9,600 bits per second.

With the correct combination of Pulsar File Transfer packages you have access to complete software freedom between IBM-PC, Sirius and Apricot and instant transfer of data from Apple. Multiple files can be sent or received with a single command, while an in-built error-checking facility guarantees absolute accuracy.

For more information on the Pulsar connection just return the coupon. Vive la difference!



**ACT (Pulsar) Ltd.**

FREEPOST Birmingham B16 1BR or call 021-455 7000

**PULSAR**  
SOFTWARE

Please send me further details on the Pulsar File Transfer:

NAME

POSITION

COMPANY

ADDRESS

TELEPHONE

# Integration from Ashton-Tate

ASHTON-TATE has introduced an integrated package to complement its dBase II and Friday databases. Framework combines word processor, spreadsheet, business graphics and database management. Aimed principally at business professionals it is intended to be easy to use, and features the now familiar paraphernalia of user-friendliness, with multiple on-screen windows, pull-down menus and desk-top metaphor.

Running initially on the IBM PC, Framework is scheduled for availability in July, at a price of £494. We used Framework at its press launch, and compared to its rivals it appears to be unusually quick.

The package is very fully

integrated: all word-processing functions are still accessible in the spreadsheet, for instance. In the spreadsheet you are allowed up to 32K in each cell, and 140 different spreadsheet functions are provided. Graphs and spreadsheets can be linked so that when you change the figures in a spreadsheet the graph changes too; both can be on screen at the same time so you can watch the graph changing.

The database section of Framework imposes no limit on record sizes, and includes powerful search and sort facilities. You can pull in data from existing dBase II files, specifying selection criteria if you like, and also from WordStar and standard ASCII files.

A complete data manipulation language called Fred is included in Framework. Ashton-Tate is not making

much fuss about Fred, preferring to push Framework as an easy system suitable for use by the non computer-literate business professional. But system developers may be interested in the flexibility offered by Fred, which is similar to the language used in dBase II.

For more details, contact: Ashton-Tate (U.K.) Ltd, Cofferridge Close, Stony Stratford, MK11 1BY. Telephone: (0908) 568866.

## Mac accounting

PEACHTREE is bringing out two accounting packages for the Apple Macintosh. The Cash Book system costs £175 and the combined Sales and Purchase Ledger costs £275. Both packages make full use of the Macintosh mouse and graphics, and should be available now.

Details from Peachtree Software International Ltd, 99 King Street, Maidenhead, Berkshire SL6 1YF. Telephone: (0628) 32711.

Peachcash's cashbook-like display for data entry.

created the best selling Zork. Set in the same universe, Sorcerer players use magical powers to overcome obstacles on the way to their goal. The game recognises a vocabulary of over 1,000 words, and the Zork/Sorcerer universe has a detailed history and geography.

Sorcerer costs £35.95 and



Sorcerer from Infocom.

## Bible games book

AN AMERICAN-WRITTEN book called *Bible Basic* contains listings of 20 games with a biblical connection. They have names like David and Goliath and People who met Christ and are mostly fairly simple text-orientated games.

The Basic contains few machine specific features, although some listings contain Vic-20 graphics commands.

The book costs £6.95 in the U.K. Details from Harper and Row, 28 Tavistock Street, London WC2E 7PN. Telephone: 01-836 4635.

## Magical powers

SORCERER is the new Fantasy game from Infocom, who

runs on disc-based Apple II, Commodore 64, IBM PC and Atari systems. For details contact: Softsel Computer Products, Softsel House, Central Way, Feltham, Middlesex TW14 0QX. Telephone: 01-844 2040.

## Commodore spreadsheet

PSS FROM Practicorp is a programmable spreadsheet for the Commodore 64. It works like a normal spreadsheet program but comes with 10 Basic modules. You can load them separately or incorporate them in your own Basic programs to handle tasks like accepting data entry or sorting spreadsheet data.

PS costs £64.95 on tape or £69.95 on disc, including VAT. Contact Practicorp, Goddard

Road, Whitehouse Industrial Estate, Ipswich, Suffolk IP1 5NP. Telephone: (0473) 462721.

## Computer insurance

AS AN ALTERNATIVE to taking out a maintenance contract, some business computer users are taking out specially tailored insurance contracts. One such scheme is offered by James Beresford Associates. Maint-Insure offers on-site repair with a 24-hour response in addition to insurance cover of fire, theft, loss of data and other computer hazards.

The cost is about 9.5 percent of your system's retail price. Details from James Beresford Associates, Meadows End House, Chapel Lane, Curdridge, Hampshire SO3 2BB. Telephone: Botley (04892) 87984.

## Golden oldie

PSS has relaunched Gauntlet, one of its old best selling games for the ZX-81. According to PSS, demand for ZX-81 games has picked up heavily recently. The company puts this down to younger brothers and sisters inheriting machines from their elder siblings.

Details from PSS, 452 Stoney Stanton Road, Coventry CV6 5DG. Telephone: (0203) 667556.

# Software for the IBM PC/XT

## A Buyer's Guide

### Start Here

First, ask yourself a few simple questions:

1. Do you want one of the best selections of software for the IBM at your disposal?
2. Do you wish to take advantage of some of the lowest prices available?
3. Do you need help, advice or technical support?

If you answer YES to any of the above, then move on.

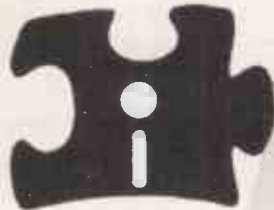

When choosing the right software package to fit into your micro environment, you may require guidance. You need to contact a company with extensive experience of microcomputers and software.



Alternatively, you may know exactly what your requirements are and simply wish to take advantage of some of the lowest prices around, making that already over-stretched budget go just a little further.

### Choice



Look at a few of the many software packages available for the IBM.

**Word:** Designed to be easy enough for a first time user, but still one of the most powerful word processing packages available. With optional Mouse.

**Lotus 1-2-3:** Information management, spreadsheet and graphics facilities in one fast, cost-effective package.

**Friday:** Aimed at the novice user, Friday is a pre-structured menu-driven information management system.

**Open Access:** A six-in-one package combining spreadsheet, 3-D graphics, word processor, scheduler, telecommunications and information manager.

**SuperCalc 3:** An advanced spreadsheet with full graphics facilities.

**The EasyWriter I System** for quick efficient word processing and the **EasyWriter II System** for more sophisticated text processing needs. **EasyFiler** data handler and **EasyPlanner** financial modeller complete the Easy family of software.

We stock a comprehensive range of software for a number of different applications, including established packages such as WordStar and dBase II, as well as the best of the latest releases.

### The Next Step



Dial 01-879 1888 and speak to Interam Computer Systems Ltd.

We'll offer advice and help in choosing the right software for your application. We also provide installation and training. Our prices are some of the lowest around.

In addition, preferential discounts are available for all educational users.

For further details or to arrange a free product demonstration. We'll also send you a free catalogue, detailing our products.

62 Weir Road, Wimbledon  
London SW19 8UG  
Tel: 01-879 1888  
Telex: 8954072

**INTEDAM**  
MICROCOMPUTER SPECIALISTS

# Microware announces a new concept in IBM sales: The immediately available PC.

If you've wasted a lot of time lately ringing IBM dealers only to find they cannot give you a delivery date, try us!

We will:

- Provide the widest range of software support.
- Offer comprehensive maintenance contracts.
- Take pride in our unparalleled after-sales service.
- Analyse and identify your requirements.
- Advise on your system needs.
- Supply and install your equipment.

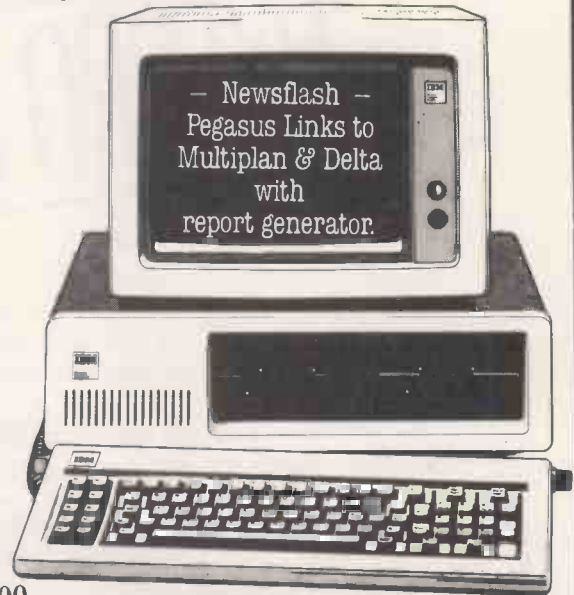

## SOFTWARE

### MULTI-USER PEGASUS £295.00

- Sales Ledger
- Purchase Ledger
- Nominal Ledger
- Invoicing
- Order Processing
- Stock Control
- Payroll
- Job Costing

### ● Auditman - £1500.00

### ● Minuteman - £750.00

### OPEN ACCESS - LOTUS EATER

### ● Only £475.00

- Database
- Spreadsheet
- 3-D Graphics
- Word Processor
- Appointments Diary
- Communications

### LOTUS 123 - £375.00

- Database
- Spreadsheet
- Graphics

### VARIOUS SELECTION

- PC Tutor 2.0 - £41.00
- CBasic - £140.00
- Pascal/MT+ £420.00
- Microsoft 'C' £384.00
- Chess - £61.00
- Norton Utilities - £56.00
- Backgammon - £35.00
- Electronic Disk - £50.00
- Copy II pc - £29.00

## DATABASE PACKAGES

- dBASE II - £375.00
- DMS - £195.00
- Delta - £495.00
- Everyman - £475.00
- Knowledge Man - £350.00

## WORD PROCESSORS

- WordStar - £245.00
- Microsoft Word/Mouse - £340.00
- Multimate - £340.00
- Wordcraft - £340.00
- Word Perfect - £425.00

- Send telexes from IBM PC - £1750.00

## APPLE LINK

- Quadlink turns PC into Apple - £495.00

## ARABIC IBM PC

- Conversion to Arabic - £590.00
- Arab Word Processor - £595.00

## PRINTERS FROM £250.00

- Epson FX-80/FX-100/LQ1500
- Brother HR15/HR25
- NEC Spinwriter
- Sheet Feeders Available
- Typeface Catalogue Available
- Acoustic Hoods from £295.00

## THE PROFESSIONALS

- Full training provided
- Free 12 months warranty
- Leasing deals arranged
- Highly competitive quotations
- Long and short term rentals

## HARDWARE

### BASIC SYSTEM

- IBM Personal Computer  
64K RAM, Single sided Disk Drive  
Keyboard, Screen - £1567.00

- IBM Personal Computer  
128K RAM, Twin 360K Drives  
Keyboard, Screen - £2087.00

### BUSINESS SYSTEM

- IBM Personal Computer  
256K RAM, Twin 360K Drives,  
Keyboard, Screen - £2299.00

### HARD DISK SYSTEM

- IBM Personal Computer  
128K RAM, 10Mbyte Hard Disk,  
Single 360K Floppy Drive  
Keyboard, Screen - £4078.00

### HERCULES GRAPHICS CARD

- Additional Cost only £185.00

### COLOUR SYSTEMS

- Additional Cost only £405.00

IBM

Personal  
Computer

IBM Authorised Dealer

# MICROWARE

## BUSINESS SYSTEMS

637 Holloway Road London N19 5SS 01-263 1124 Telex 297598  
14 Charles Street Hanley Stoke-on-Trent 269 883

**STOP PLAYING AROUND  
GO TO**

**22 VIRGIN GAMES CENTRE 01-6377911**

**OXFORD STREET LONDON W1.**

for the widest range of software for the ZX Spectrum, Commodore 64, VIC 20, and Atari plus many titles for the Dragon, Apple, BBC and Electron.

New titles are stocked within hours of release - call our friendly knowledgeable staff for details.

**VIRGIN GAMES CENTRE, 22 OXFORD ST., LONDON W1. 01-6377911**

● Circle No. 119

# PICK UP THE PHONE FOR THE BEST PORTABLE PACKAGE.

**(0280) 816087**



**APRICOT**  
from  
**£1495**



**OSBORNE**  
from  
**£945**



**SANYO**  
from  
**£749**



**EPSON**  
QX10 **£1735**  
PX8 **£798**

**FREE WITH EVERY SYSTEM:-**  
Bundled software including Word Processing, Spreadsheet, BASIC and Operating System.

- Impartial advice from trained consultants.
- On site training.
- On site servicing & fully equipped workshops.
- Complete After Sales telephone support.

**THIS MONTH'S SPECIAL OFFER**  
**APRICOT & PRINTER**





**FRASER**  
Associates Limited

1 Bristle Hill, Buckingham MK18 1EZ Telephone (0280) 816087

● Circle No. 120



# Look over the Rainbow with Microware.

We offer you:

- Free 12 months on-site warranty.
- 4-hour on-site response at modest cost.
- Computer-based instructions.
- Free Digital training vouchers.
- Generous trade-in allowances.



## SOFTWARE

### LOTUS 123

- only £375
- Database
- Spreadsheet
- Graphics

### PEGASUS

- only £295 each
- Sales Ledger
- Purchase Ledger
- Nominal Ledger
- Invoicing Ledger
- Order Processing
- Stock Control
- Payroll
- Job Costing

### INCOMPLETE RECORDS

- Ideal for Accountants
- Auditman - £1500
- Minuteman - £750

### DEC GP

- Practice and Patient Records
- Health Service information to FPC
- Reduces Clerical and Professional Workloads
- Produces repeat prescriptions
- Analysis of practice data
- Secure against unauthorised access
- Totally Integrated System

### VARIOUS SELECTION

- Multiplan
- TK! Solver
- Select Wordprocessor
- WordStar Mailmerge
- Wordcraft
- dBASE II

### THE PROFESSIONALS

- Full training provided
- Leasing deals arranged
- Long or short term rentals
- Highly competitive quotations
- Book your demonstration now!

## HARDWARE

### RAINBOW 100B

- 128K RAM, Twin 400K Drives
- Amber or Green Monitor
- Keyboard, MS DOS, CPM 80 86
- Self teach disk, Stand and Customer Services Package - £2767

### RAINBOW 100B + LA50 PRINTER

- As above but with LA50 - £3276

### RAINBOW 100B + LA100 PRINTER

- As above but with LA100 - £4017

### RAINBOW 100B + LQPO2 PRINTER

- As above but with LQPO2 - £4755

### RAINBOW 100 + HARD DISK

- 128K RAM, Twin 400K Drives
- 10 Mbyte Hard Disk,
- Choice of Screens
- Keyboard, CPM 80 86, MS DOS,
- Self teach disk, stand and Customer Services Package - £4200

### COLOUR SYSTEMS AVAILABLE

- Additional cost only £820

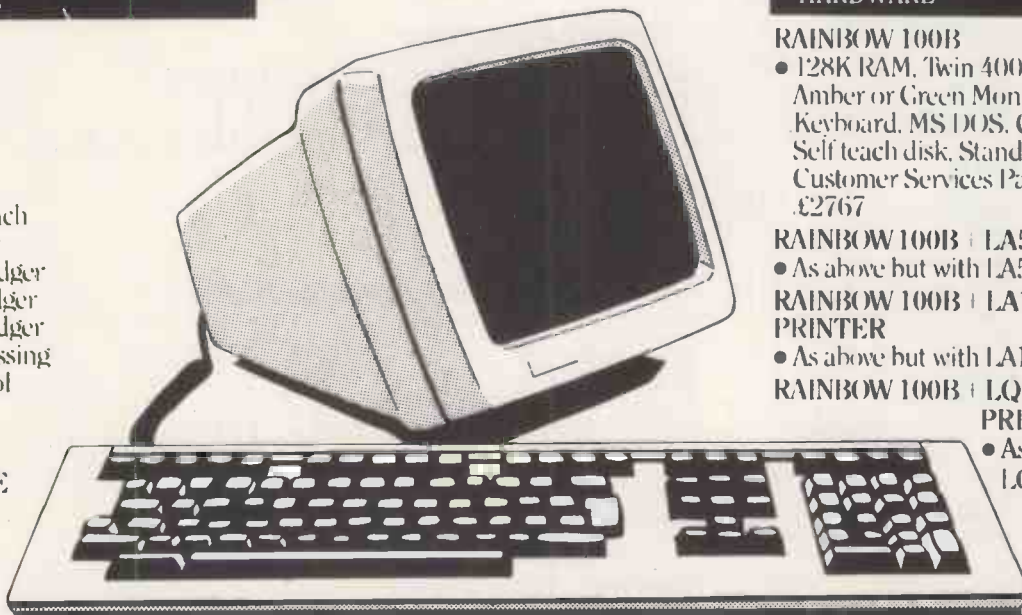

14 Charles Street, Hanley, Stoke-on-Trent 269 883

# MICROWARE

BUSINESS SYSTEMS

637 HOLLOWAY ROAD, LONDON N19 5SS

TELEPHONE 01-263 1124 TELEX 297598

● Circle No. 121



# You can now buy these



COMPUTER PRINTER FORMS  
FOR DATA LISTING  
9½" wide (241mm) x 11" deep  
1 part Continuous – Green Ruled

# as easily as you can buy these



At last. Top quality plain Kleen Edge letterhead style or green ruled Computer Stationery for your microcomputer or word processing system in easy-to-carry boxes of 500 forms. Blue Chip-produced by Moore Paragon the UK's leading computer stationery manufacturer-is available from leading stationers and computer dealers. For details of your local stockist and samples ring 045 55 57191.



● Circle No. 123

# EVERYMAN™

## The Database

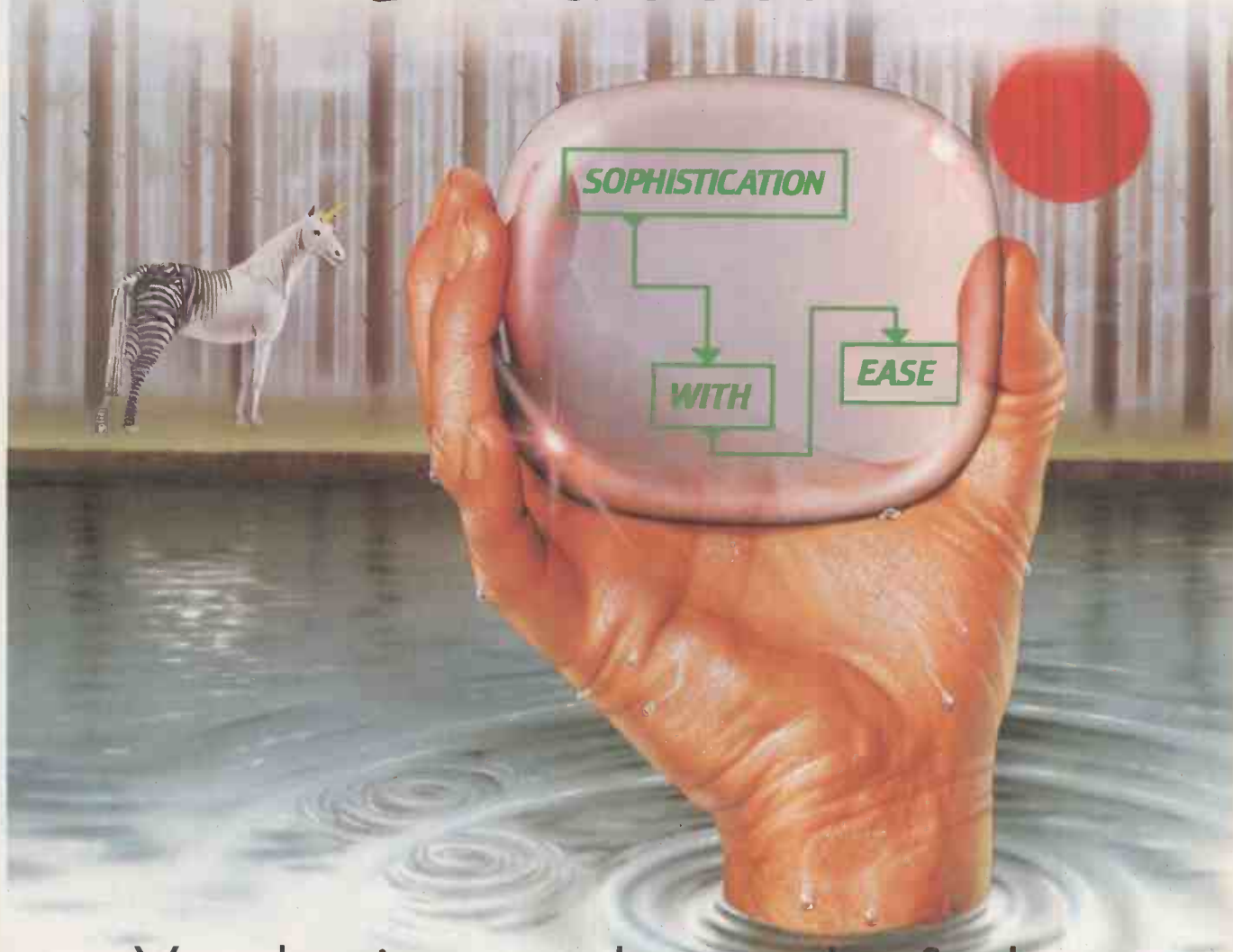

## Your business at the touch of a key.

EVERYMAN is the information system designed to turn your 16 bit micro into a business tool more powerful and more flexible than you dreamed possible.

Using a revolutionary new visual concept that requires no programming and offers no language barrier, EVERYMAN allows you to paint solutions to problems, however complex, directly on the screen. It's so easy to understand you'll be an expert from day one – an expert with easy access to multiple files and (thanks to EVERYMAN'S window functions) able to cross reference and view your data any way you like. Within minutes you can model solutions to your own 'real world'

problems – solutions that can be recalled at the touch of a key at any time, while EVERYMAN maintains the logic and database integrity for you.

EVERYMAN is supported by full documentation including a tutorial that allows you to run like an expert in around 3 hours (with a little aid from EVERYMAN'S help screens if you need it). The whole package is backed by a comprehensive 12 month guarantee that includes upgrades to all registered users.

Talk to your dealer today about EVERYMAN – it'll put you generations ahead!

# EVERYMAN™

**vector**  
international

...THE RIGHT DIRECTION

Vector House, 6a Lower Teddington Road, Hampton Wick, Kingston-upon-Thames, Surrey KT1 4ER. Tel: 01-943 1257/8/9/0.

● Circle No. 124



# The latest picture show

Despite the fantasies of film producers it will be a good few years before home micros can provide ultra high-resolution graphics.

TREMENDOUS ADVANCES have been made in microcomputer graphics and display processing during the last few years. Yet there can be little argument that there is still a very long way indeed to go before your pet home machine can even come close to providing the level of performance so eagerly predicted by science fiction films and television advertisements.

The unfortunate truth is that when TV and film directors need some impressive-looking computer graphics for *Hitch-Hikers Guide to the Galaxy*, *Star Wars*, and the like, they are more likely to turn to the tedious Mickey Mouse animation of the rostrum camera than they are to use a real microcomputer. The reason, of course, is that compared with the sort of graphics that will one day be available on every home micro, today's reality seems about as far advanced as a Lascaux cave painting.

## Frustration

Even more frustrating is that the required range of colours and the picture-resolution potential is available now from our domestic television. It is the micro itself which lets the side down by being slow, inflexible, and damned hard to program to do anything really useful.

The fact that all the best animated computer games are written mainly in machine code says it all. Writing a complex game from scratch in assembly language has to be strictly for computer freaks with nothing much else to do with their time. Attempts to write animated games programs in Basic may teach you a lot about computing, but only show the results of your labours to your very best and most understanding friends if you don't want to be laughed at.

To take more advantage of the display potential offered by a standard 625-line colour TV or monitor, big improvements are needed in two vital areas. The speed at which pictures can be created and modified must be substantially increased, and it must become much easier to program the system to display exactly what you want to see on the screen. Another requirement is access to a high-resolution screen-refresh memory, containing perhaps one quarter of a

megabyte of memory to allow eight bits of intensity and colour information per pixel in a 512-by-512 format display, but this will soon be available when the new generation of 256Kbit dynamic-RAM chips arrive on stockists' shelves.

To achieve faster, easier to program display control with existing microprocessor chips requires a new type of video-display processing peripheral. It will have to provide high-level graphics functions directly in hardware, unloading many of these time-consuming chores from the processor and leaving it free to concentrate on the higher strategy of the game or simulation under way. A software graphics operating system will also be required, of course, but if many of the high-level functions are being performed directly in hardware this should be a straightforward matter.

Before too long these needs will be satisfied, and our video processing capabilities will be hauled out of the stone age and into the 20th century, thanks to a couple of new chips from Motorola and a similar one-chip system from Texas Instruments. The Motorola pair consists of the MC-6847 raster memory controller or RMC, and the MC-68486 raster memory interface or RMI. They are known collectively as the RMS or raster memory system. Texas calls its single chip the AVDP, or advanced video display processor.

## Two technologies

Motorola has opted for separate chips so that different semiconductor fabrication technologies can be used for the two functionally separate circuit blocks. The RMC, containing most of the fancy control logic, is made using the medium-speed high-density HCMOS technology. The RMI, which controls much of the video and memory timing logic, uses the very high-speed oxide isolated bi-polar technology, called Mosaic by Motorola.

This functional optimisation makes it possible for Motorola to be very ambitious with the RMS specification, providing a graphics resolution of up to 500 lines with up to 640 pixels per line, or up to 80

characters per line in text mode. A colour capability of 32 simultaneous hues from a palette of 4,096 is also provided, as is bus compatibility with most Motorola microprocessors, including the 6809, 68000 and the 68008.

One of the main objectives of the Motorola design team was to achieve compatibility with the American videotext format known as NAPLPS, a less than memorable acronym which stands for North American presentation level protocol syntax. But flexibility is the keynote, and the RMS can handle most other display requirements with ease. The new chip set can address up to a megabyte of video memory and also provides the useful facility of roving scroll, in which the actual display screen area is defined independently of a larger virtual image memory area.

## NMOS compromise

The Texas AVDP addresses the same display needs as the Motorola RMS, and promises to grace a wide range of future low-cost consumer applications. It uses the compromise NMOS technology, which may explain the reduced graphics resolution available of 256 by 210 pixels. Both the RMS and AVDP uses on-chip registers for control and communication with a microprocessor host, and both provide a variety of high-level video functions directly in hardware. Such functions have hitherto required considerable software gymnastics.

One of the most useful functions for games designers is the ability to handle discrete display blobs — called true objects by Motorola and sprites by Texas — which could be used to represent spaceships, frogs or whatever. In current games software, a lot of processing time is wasted in checking for collisions between sprites. In the new chips, numerous multi-colour objects can be tracked simultaneously by the hardware, and all collisions reported immediately via a single-data byte. With technology like this now becoming available, look out for stunning new video capabilities on even the cheapest systems in a year or two. ■

# Why you should buy a computer you've never heard of, when you know you want an IBM PC.

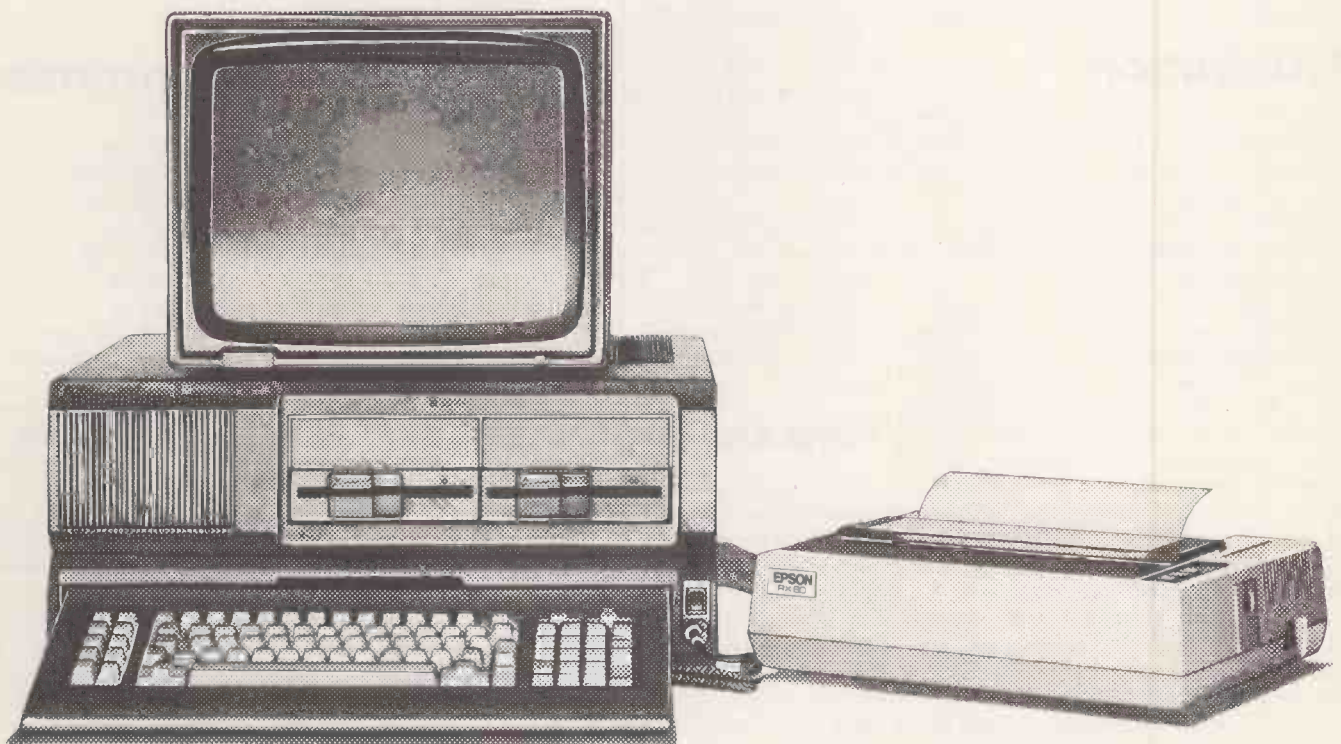

Advance 86b specification. Intel 8086 CPU. MS DOS operating system. Twin-disk drives. 128K RAM expandable to 640K. Interfaces for light pen, printer/plotter, joystick, monitor and RS232C. Capacity for 4 expansion boards, plus a further 2 true 16 bit slots. Graphics - 16 colours, 80/40 columns x 25 row text, 640 x 200 pixels. Package illustrated Epson RX80 F/T Printer (£325 inc. VAT) and Microvix monitor (£249 inc. VAT).

 \* Excluding N. Ireland. Subject to availability. Prices correct at time of going to press. 

**Y**ou've probably never heard of the Ferranti Advance 86b. But then, once upon a time you'd probably never heard of the Sinclair ZX81 either.

In 1981, we became the exclusive stockists of this computer, which has since gone on to become the best selling personal computer ever.

In 1982, we were the first High Street retailer to make the Sinclair Spectrum available to the general public. Again, most people at first knew nothing of its existence, and again we've sold thousands.

In 1983, we were the first national High Street retailer to stock Acorn's domestic version of the highly successful BBC Micro, the Electron. And now, in 1984, we're continuing the story by stocking a new, advanced, business computer.

The Advance 86b Personal Computer, made by Ferranti.

So far, of course, few people have heard of it. The Advance 86b, based on a true 16-bit micro-processor, has a user memory of up to 640k, and dual 360k disk drives. It runs IBM software, and runs it faster than any equivalent IBM PC. Simply because the microchip it uses is more advanced.

The Advance 86b costs £1,499 (inc. VAT) and comes complete with four free software programs – spreadsheet, wordchecker, word processor and database.

The package shown includes a monitor and printer and at £2,073 (inc. VAT) costs less than half of the equivalent IBM PC package.

What's more, your Advance 86b will be backed up by a full 12 month warranty.

Which means that, should it develop a fault it will be serviced free of charge, anywhere in the U.K.\*

Of course, it goes without saying that such a computer is exclusive to us at W. H. Smith.

# WHSMITH



Birmingham, Bradford (Broadway), Bristol, Cambridge, Cardiff, Edinburgh, Exeter, Glasgow, Kingston-upon-Hull, Leeds, Leicester, Liverpool, London: Brent Cross, Bromley, Croydon, Ealing, Hammersmith, Heathrow Airport, Holborn Circus, Kensington High Street, Kingston-upon-Thames, Sloane Square, Wood Green, Manchester, Newcastle-upon-Tyne, Northampton, Nottingham, Plymouth, Reading, Sheffield, Southampton, Swansea, Wolverhampton.

● Circle No. 233

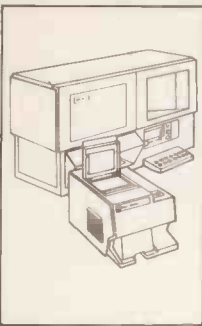

### Updatable information system

The Microx System from Bell & Howell is a microfiche information-processing machine. You can add, annotate, erase or replace information more easily than with a paper-filing system. In fact, the Microx records, files, processes, retrieves — and prints, all in a matter of minutes and can be locked after use. The Microx records images on photo-plastic film masters — hard wearing and easily handled in normal light. Each master holds up to 98 documents and a grid reference allows easy identification. I have full details.

378 on enquiry card

### Shredders for computer print-out

The increasing use of word processors, printers and computer installations means that Business Aids' electronic Scimitar Data Shredders are in greater demand than ever. The Compact Data 1001 is ideal for the smaller computer user; models 2001 and 2002 accept 25 sheets or eight streams of continuous stationery, while the high-security 2002XC converts paper into illegible 2 x 15mm chips. Data 4001 is a wide-throated console model; the heavy duty Data 5000 and 6000 have a 30-sheet capacity and process up to 20 streams of print-out simultaneously. Contact me now.

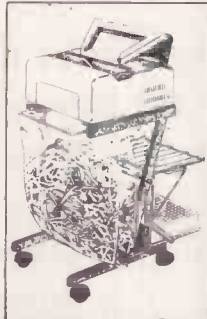

379 on enquiry card

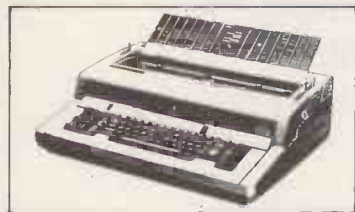

### The Trend 930 printer means business

The latest addition to Trend's successful 900 series of high speed printers is the 930 printer. This versatile machine gives dual mode printing. When your letters need to create the best impression select the Executive Quality 80 characters per second, with the daisywheel look-alike finish. For office memos, etc, choose the Draft Mode with its quick 200 cps speed. The 930 will handle cut sheets and multi-part fanfold forms. Optional sheet feeder available. Contact me now for more details of this superior WP printer.

381 on enquiry card

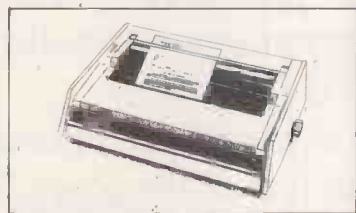

### A typewriter to remember

The latest edition from Silver Reed is the Intelligent EX66 Electronic Memory Typewriter. Featuring a 20 character, liquid crystal display, a 32 character key buffer and 2-line 512 character correcting memory, it makes the typist's job so much easier. Simultaneous text typing and storage are possible, thanks to a built-in 8K text/phase/format memory that can be expanded by another 8K to a maximum of 16K. Upgradability is further enhanced by the optional interface. In the automatic printing mode bi-directional printing is standard and to make your secretary even happier, it comes with a host of sophisticated hardcopy and editing features. A super machine, let me send you full details.

380 on enquiry card



### A new range of acoustic printer covers

Noise reduces efficiency in offices. Twinlock now introduce a new range of five Acoustic Printer Covers and make it possible for printers to be the work-and-time savers they were designed to be. The flame retardant acoustic foam lining reduces printer noise by up to 90%. A clear acrylic lid for observation, double-hinged with gas-struts for easy access, also acts as a dust protector. A quiet, long-life fan keeps the printer cool, and a unique two-way plug (British Standard) caters for the fan and printer together. Twinlock can assist you in finding the correct model for your machine. Simply contact me.

40 382 on enquiry card

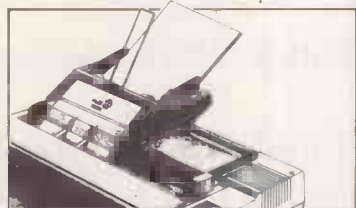

### Low cost sheet feeder

The Easifeed 230 sheet feeder is specifically designed for the new generation of low cost matrix and daisy-wheel printers such as the Epson, OKI, Juki, Uchida, Daisy Step 2000, Star, Silver Reed, Towa and Qume 12/20 ranges. The unit is fully mechanical and can be fitted in a few minutes enabling faster throughput of mail shots and reports onto letterheads, forms or standard A4 paper. The 230 is very reasonably priced and comes complete with installation and operating instructions. WBM Business Supplies, UK distributors, also market the larger 235 sheet feeder suitable for Qume, Diablo, Ricoh, NEC, etc. Find out more about the efficient sheet feeders. Just circle this number.

383 on enquiry card

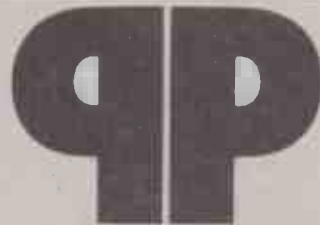

PAGE PLUS Computers

COMPILED BY-

*Mr Sula Hewitt*

Maple House, Heath Drive,  
Walton-on-the-Hill, Surrey. KT20 7QJ  
Tadworth (073781) 4139



### Why does this man look so bored?

Quite simply because he's waiting for his microcomputer colour printer to deliver twenty colour prints. You see, he understands the value of printing in colour but doesn't know how to go about it quickly. Now if he'd only thought to visit his local Xerox Copy Centre, he'd have all the quality colour prints he wanted — and in a fraction of the time. Ah! you say. But colour prints cost money. Well yes they do. But at the Xerox Copy Centre, far less than you'd think. Just £1\* a copy, in fact. And if you contact me now you'll receive three £1 money-off vouchers!\*

\*exc VAT 384 on enquiry card

### A free Microwriter course

250 business people have been very enthusiastic with the free Microwriter self-teach course that was offered here in January. Microwriter are now repeating the offer to another 250 business or professional people who circle the number below. This is your chance to find out for yourself how easily you can touch-type with the Microwriter within minutes. Thousands of business people all over the world are using the Microwriter portable word processor daily for correspondence, reports, notes and any other written work. The remarkably simplified five-finger keyboard can produce the entire alpha/numeric range and other functions.

385 on enquiry card

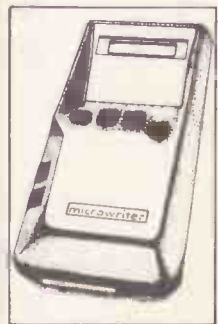

### Xerox telecopier

Send a document across the world in just two minutes with a Xerox facsimile terminal. It speeds up business and means important decisions can be made immediately. And there's a model to suit your exact need. The Xerox Telecopier 455 sits conveniently by your telephone. The 485 can handle up to 30 originals and receive up to 300 pages at a time. For bulk transmission the 495 can transmit an A4 letter in under a minute; its auto dial facility can make calls and transmit documents 24 hours a day. British Telecom Approved. I have full details. Just circle this number.

386 on enquiry card



### Pick-up. Speak-up. Hang-up.

That's how simple it is to use the new Dictaphone Thought Tank recorder — a direct-to-secretary dictation/communication system. To get your words on paper fast — or just leave a message — pick-up the handset and start talking. No cassettes to handle or mislay. No time wasting. The 1925 is instantly available for round-the-clock recording — with a special top priority hot-line feature. It copes with more than one user, so your secretary can make more effective use of her time. It's fast, adaptable and at £7.99 per week it seems ideally affordable for small work groups/companies/individuals. I can send you full details.

387 on enquiry card



### Time recording — automatically

Hengstler, world leaders in the field of time recording, brings you a unique system, the Datamod 8020. It can handle up to 25 different work patterns simultaneously and the software can be tailored to meet your specific requirements. Whatever schedule you operate — shiftwork, fixed or flexible hours — the Datamod will deal with it efficiently. In addition the system has the facility to automate the collation of personnel statistics, including lateness, sick leave and holidays. Hengstler has a full range of time recording equipment. Let me put you in touch.

388 on enquiry card

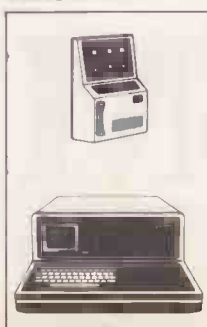



# Now There's a Choice



## New The RAIR Business Computers

Now there's a choice of RAIR Business Computers, from an entry level floppy disk system, through a high-capacity hard disk system, to our established high-performance multi-user system, all fully compatible and upgradeable.

Our new RAIR Business Computers incorporate a host of advanced features, including new high speed dual 16-bit and 8-bit processors for high performance and software compatibility, colour displays for increased legibility, and multiple printers for user convenience. And our new software catalogue offers the best in business

packages, including the latest Peachtree Business Management System, dBase II database manager, WordStar Professional word processor, SuperCalc II spreadsheet, and many more, all implemented for full 16-bit multi-user operation in colour.

So when you're choosing a new computer for your business, the choice is obvious – a new RAIR Business Computer.

For full details of the new RAIR Business Computers phone Teledata on 01-200 0200, or write to RAIR Limited, 6-9 Upper St Martins Lane, London WC2H 9PS.

# RAIR

Peachtree is a trademark of M.S.A. dBase is a trademark of Ashton Tate WordStar is a trademark of Micropro Supercalc is a trademark of Sorcim

# New from Casio that fit your

Two new portable micros from Casio. The **PB700** and the **FP200**. Both sophisticated, reliable and compact.

Casio have a worldwide reputation for high quality workmanship, coupled with value for money prices; it's a reputation that was first established in the calculator

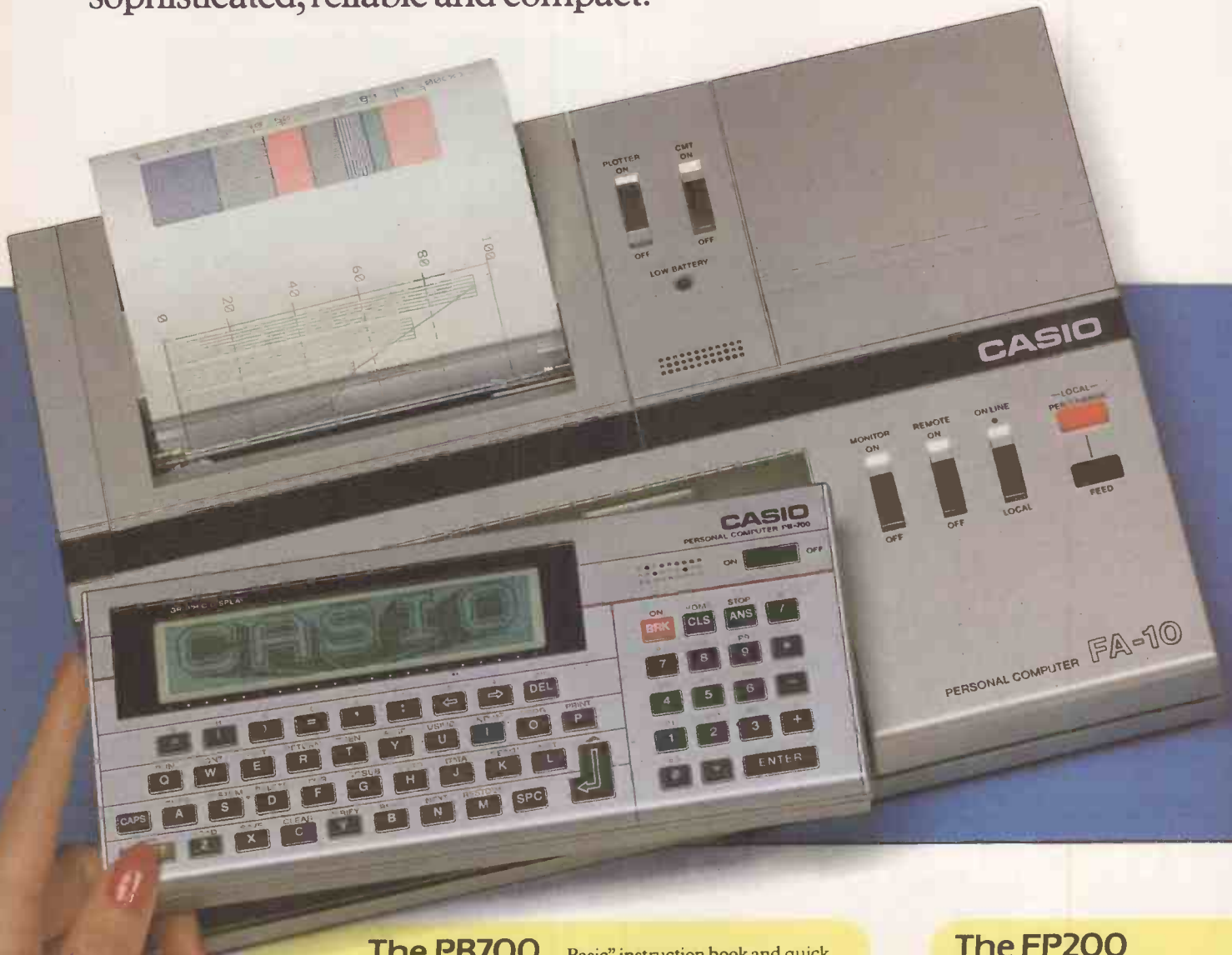

## The PB700

● Powerful pocket micro with extensive graphic capabilities and the potential for system expandability.

### Memory

- 4K RAM expandable to 16K with OR4, 4K RAM modules.
- 25K ROM.
- 20 character x 4 line display with 160 x 32 dot graphics.
- FOR-NEXT loops to 6 levels, 12 levels of sub-routines.
- Power source: 4AA size batteries plus lithium cell for RAM back-up.
- Complete with "Easy Trip to

Basic" instruction book and quick reference guide.

### Optional Accessories

- FA10 — with 4 colour 115mm wide paper plotter, external cassette with interface; cassette remote control; mains adaptor.
- FA4 — with centronics standard, 8 bit parallel interface; external cassette interface; cassette remote control; mains adaptor (optional).
- CM1 — built-in micro cassette module (optional).
- OR4 — 4K RAM modules.

## The FP200

● Compact portable computer with versatile spreadsheet programme, based on Casio's Easy Table Language (CETL).  
● Programmable in BASIC and CETL.

### Memory

- 8K RAM expandable up to 32K RAM with FP201, 8K RAM modules.
- 32K ROM expandable to 40K with FP205 8K ROM module.
- 20 character x 8 line display with 160 x 64 dot graphics.

# CASIO

# -mighty micros briefcase

market, moved into watches and electronic musical keyboards and is now advancing into the world of micro computers.

Advanced technology. Painstaking quality control. Modern design. They all play their part.

Just some of the reasons why you should check out the new Casio portable micros.

## The Casio Portable Micros

The two new portable micros featured here, both offer that famous Casio reliability. They both offer the user a compact micro, that is already supported by a range of programmes from some of the U.K.'s leading software houses, as well as Casio themselves.

And Casio micros are designed to grow with your needs. You can add to the memory, and there is a range of options available.

There's also Casio's comprehensive range of instruction books to help you get the most from your micro. So however fast you expand, Casio will help you keep pace.

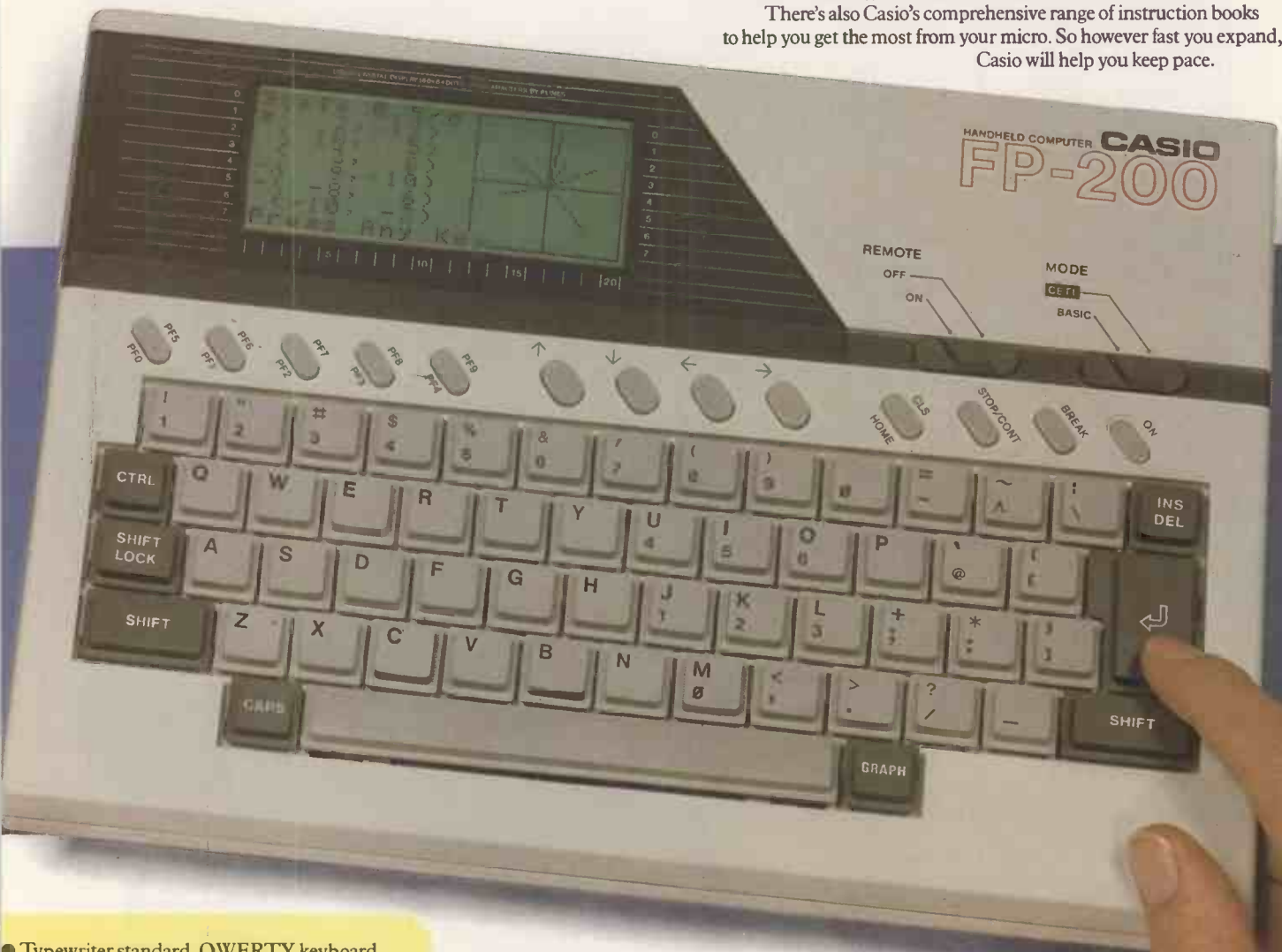

- Typewriter standard, QWERTY keyboard.
- 3 extensive instruction and reference manuals.
- Centronics parallel, RS232 serial and cassette interface built in.
- Power source: 4AA size batteries with 2AA size for memory back-up.
- Dimensions - 310mm x 270mm x 55.5mm.

### Optional Accessories:

- FP1011PL - 4 colour printer plotter.
- AD4180 - mains adaptor.
- FP201 - 8K RAM.
- FP205 - 8K ROM.

### Casio approved software available from:

Kuma Computers Limited. Telephone No. Pangbourne (07357) 4335.  
 Micros for Managers. Telephone No. 01-370 5125.  
 Casio Electronics Company Limited. Telephone No. 01-450 9131.

For further information please write to: Mr A Manton,  
 Product Manager Computers, Casio Electronics Co Ltd,  
 Unit 6, 1000 North Circular Road, London NW2 7JD.

Please send complete details on PB700/FP200\* PC7/84

NAME \_\_\_\_\_ (BLOCK CAPITALS)

COMPANY \_\_\_\_\_

ADDRESS \_\_\_\_\_

POST CODE \_\_\_\_\_ TEL. NO. \_\_\_\_\_ AGE \_\_\_\_\_

\*Delete as applicable. Circle No. 246 Dealer Enquiry Yes/No **47**

# MAGIC!

# Is the writing on the wall for other printers?



Looking for the perfect printer for your micro? Look no further than Dataproducts - the world's biggest independent printer maker, and 'own label' supplier to most of the major computer manufacturers.

Now that same quality is available direct to you at competitive prices from your nearest dealer. Whether you want it for letters, reports, bar-charts or spread sheets. Feature for feature, we knock spots off the competition.

Like the new 80-column 8010 shown here, or the 8020 132-column version, both near letter-quality dot matrix printers with three printing speeds for data or word processing. That handle multi-part forms and single sheets as easily as continuous stationery. That mix text and graphics in a single line; that are ideal for office or home use.

(They've got combined serial and parallel interfaces on the one card, too, as well as IBM PC-compatible 8011 and 8021 versions.)

Or the P132 colour printer, that again outperforms the competition. Whatever your micro, whatever your printer requirements, you'll find our Paper Tigers exactly right for the job.

Take a look at them at your local dealer and find out how you could be one of the lucky winners of a two-week African Photo Safari, plus valuable runner up prizes.

Paper Tigers from Dataproducts. Bite for bite, the best!

Dataproducts Limited, Retail Division,  
136/138 High Street, Egham, Surrey TW20 9HL.  
Tel: (0784) 38733. Telex 298562.

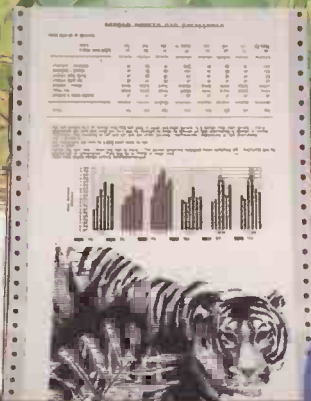

**Dealers:  
Send for  
support  
pack!**

## Dataproducts

Nobody puts ideas on paper so many ways.

## Paper Tiger

● Circle No. 132

PRACTICAL COMPUTING July 1984



# A jolly good sort

How to get the best from the Shell sort — with listings in C and Basic.

YOU CANNOT TRAVEL far in the world of programming before you come up against the problem of sorting. Choosing the best method of putting a list or table into sequence is a major preoccupation of software writers. All sorting techniques are a compromise between time, space and effort; if you choose the wrong one there could be a disastrous effect on your program's efficiency.

At one end of the scale is the exchange-pair class of sorts. They are very easy to write but take forever to run. At the other extreme there are sorts based on binary trees and recursion. They are highly efficient but require fairly complex coding. As a general rule, the faster the sort the more RAM it needs for storing pointers or stack-dwelling variables.

If pressed to name a good all-round sort suitable for everyday use by the average programmer I would opt for the sorting

method invented by D L Shell and which bears his name. The Shell sort is only slightly harder to program than the simple exchange sorts, yet it requires no additional memory and it runs an order of magnitude faster. If you ranked all the well-known sorts in order of efficiency, Shell would appear around about halfway along the list.

To obtain comparative timings a table of random 32-bit floating-point numbers was sorted using the Shell and exchange-pair sorts. The sorts were written without Rems in interpreted Microsoft Basic, and run on an 8085-based system.

Table size	Shell sort	Exchange sort
250	37s.	3min.
500	1min.15s.	12min.10s.
1,000	3min.25s.	49min.30s.

Table 1. Comparison of sorting speeds.

A Shell sort is very similar to an exchange sort except that it starts by comparing far-apart elements. The exchange sort, by contrast, always compares adjacent entries, in effect sorting each successive pair in turn until the table is finally in sequence. In bad cases — for example, where many of the early values in the table belong high up in the sequence — the exchange sort might need an entire pass merely to move one entry to its rightful place.

The Shell sort runs faster because it needs fewer passes of the table. Suppose you wish to sort a table of 100 values. The Shell might start by comparing, and exchanging if necessary, the values at locations 1 and 51, then 2 and 52, and so on. On the second pass the distance between the compared elements is halved. So now it is sorting elements at locations 1,26 and 51, then 2, 27 and 52 and so on.

(continued on next page)

## Superior software from CPMUGUK

IF YOU ARE on the lookout for high-quality software at very low prices you ought to find out if there is a user group for your computer, operating system or programming language. Many of these groups run program libraries or software exchange schemes, and you can often lay your hands on some very useful programs for next to nothing.

Leader in the field is the CP/M User Group for the United Kingdom, CPMUGUK which publishes 14 volumes of contributions from its own members — nearly 500 separate programs — and which also distributes the libraries of its opposite numbers in the U.S. and Australia. CPMUGUK makes no charge for the software; you pay only for disc copying and postage.

VFile is, according to R G Taylor its author, "designed to let the user browse through a file at leisure". You can use it with either text or binary files, the data being displayed in ASCII, hex or both at the same time. Its nearest equivalent is probably DDT, but VFile is much easier to use and its display is far better — although, unlike DDT, you cannot use it to alter a file.

As well as allowing the user to scroll

in all four directions, VFile has a random-access feature, permitting you to go straight to any specified record, which may be either a line of text or a block of binary data. You can switch between text and binary or alter the record length at will. In the three months that I have had it, I have found VFile invaluable.

Another invaluable program is Sweep, contributed by Robert Fisher. Sweep sets out to provide many of the file and directory functions that Gary Kildall should have put into CP/M but didn't. Once you get the hang of it you will use it time and again in preference to Pip, Era, Ren and Type.

Sweep works by displaying each file name in turn, either in an entire directory or within a specified user area, then prompting for a user action. At this stage you can copy the file to another disc or user area, delete it, rename it or view it. You can also tag the file for subsequent bulk operations such as bulk copy or bulk erase.

Bulk copy provides a very convenient way of copying a list of files with unrelated file names, such as a group of text files or all the Com and overlay

files that make up a specific package. Because Sweep resets the disc system after each bulk copy you can change the receiving disc and repeat the copying any number of times. It is ideal for those who wish to distribute files among several users or machines.

With bulk erase you can delete all tagged files, or all files except those that are tagged. I find this very useful for cleaning up directories that have become full of test data, demonstration files and the like. Finally, there is a batch rename feature, which is something I often wished was included in CP/M itself. It provides a form of Find and Replace within the directory. To give a simple example, you can use it to locate all files whose names are in the form \*.Com and to change the extension of each one to CMD.

Sweep and VFile are just two of the gems in the CPMUGUK library. Not unreasonably, the programs are available to members only, but the subscription is modest. Members also receive the group's excellent journal, which is full of programming tips. CPMUGUK's address is 72 Mill Road, Dartford, Kent.



```
shell(v,n) /* sorts the table v[0]...v[n-1]
            based on the routine on page 58 of
            Kernighan & Ritchie's book "The C Programming
            Language"
*/
int v[],n;
{
    int gap, i, j, temp;

    for (gap=n/2; gap>0; gap/=2)
        for (i=gap; i<n; i++)
            for (j=i-gap; j>0 && v[j]>v[j+gap]; j--gap) {
                temp=v[j];
                v[j]=v[j+gap];
                v[j+gap]=temp;
            }
}
```

Listing 1. Kernighan and Ritchie Shell sort in C.

```
3500 SHELL SORT
3510 THIS ROUTINE SORTS THE TABLE KEY$( ), THE NUMBER
      OF ENTRIES OF WHICH IS CONTAINED IN THE VARIABLE
      KCOUNTZ (1000 IN THIS EXAMPLE). THE FIRST ENTRY IS
      AT LOCATION ONE, NOT ZERO.

3520 GAPZ=511
3530 WHILE GAPZ>0:
      FOR JZ=1 TO KCOUNTZ-GAPZ
3540     FOR JZ=JZ TO 1 STEP -GAPZ:
          IF KEY$(JZ)>KEY$(JZ+GAPZ) THEN
              SWAP KEY$(JZ), KEY$(JZ+GAPZ)
          ELSE
              3560
3550     NEXT JZ
3560     NEXT JZ:
          GAPZ=GAPZ\2
3580 WEND
3590 TABLE IS NOW IN SEQUENCE
```

Listing 2. Basic version.

(continued from previous page)

The process repeats, with the gap halving each time. When the gap finally reaches 1 the Shell sort becomes, in effect, an exchange sort. Because the earlier passes were able to put most of the values near their eventual locations, the final pass has very little work to do.

Although Shell has been around for many years, it was Kernighan and Ritchie who brought it to a wider audience by using it as an example in their book *The C Programming Language*. K & R's version of the Shell sort, coded in C, is shown in listing 1.

It is worth thinking carefully about the initial distance between elements, represented by the variable Gap in the listing. K & R simply set it to halve the table

size, which will work perfectly well. But the sort will be more efficient if the initial gap is between N and N/2, where N is the table size, and also if it is chosen in such a way that all subsequent values are odd.

A value for the gap that meets the second of these conditions is a number of the form  $2^n - 1$ , where n is a positive integer. The first condition can be met by setting n to the base-2 logarithm of the table size. This can easily be done in, say, Basic with an instruction such as

$$\text{GAP\%} = \text{INT}(\text{LOG}(N)/\text{LOG}(2)) - 1$$

So if the table contains 1,000 entries the gap would be 511. These are the values used in listing 2, which shows the same routine coded in Microsoft Basic.

What improvements in efficiency can be

expected from the Shell sort? With an exchange sort, the run time increases quadratically with the table size. If it takes eight seconds to sort 100 items, it will take 32 seconds to sort 200, and over two minutes to sort 400. In a Shell sort the run time appears to increase by a factor of about 2.2.

Of course, the actual sort time depends on the hardware and programming language used and on the type and size of the data to be sorted. To get a rough idea of the comparative times involved I ran a test of an exchange and a Shell sort on identical data, with table sizes varying between 250 and 1,000. The results of this test, shown in table 1, indicate at a glance how very much faster the Shell sort runs. It is well worth the extra effort needed to program it.

## microFAST LATEST PRICE BREAKTHROUGH

### Colour Monitors

Microvitec 1431	£197.00
Microvitec 1451	£297.00
Fidelity CM14	£209.00

### Monochrome Monitors

Sanyo DM2112	£75.00
Sanyo DM8112CX	£99.00
Teco Zcom	£105.00

### Combined TV/Monitors

ITT RL2301	£280.00
------------	---------

### Acorn Products

BBC Model B	£399.00
BBC Model B with fitted disc interface	£469.00
Electron	£199.00
DFS Kit	£97.00
Data Recorder	£32.00

### Torch Products

ZEP 100	£299.00
Z80 DP2	£699.00

### BBC Disk Interfaces

Kenda Mighty Oak	£90.00
Kenda Professional (Double Density)	£130.00

**ALL PRICES SHOWN INCLUDE V.A.T.**

These prices are for cash and carry sales

### Dot Matrix Printers

Star Gemini 10X	£224.00
Star Delta 10	£365.00
KDC FT-5001	£259.00
Epson RX80	£249.00
Epson RX80 F/T	£279.00
Epson FX80	£379.00

### Serial Interface Conversions

8143 - Epson	£30.00
8148 - Epson (2K buffer, XON/XOFF protocol)	£65.00
Juki	£55.00

### Daisywheel Printers

Juki 6100	£375.00
Silver Reed	£315.00
Daisy Step 2000	£289.00

### Daisywheel add-ons

Juki Sheet feeder	£239.00
Juki Tractor feed	£109.00

Product range constantly expanding. phone for latest details

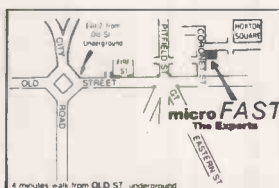

### Single Disc Drives

100K(200K) Single-Sided	
40 Track	£150.00
200K(400K) Double-Sided	
40 Track 3-inch	£190.00
400K(800K) Double-Sided	
80 Track	£219.00
80/40 Track	£248.00

### Double Disc Drives

400K(800K) Double-Sided	
40 Track 3-inch	£374.00
800K(1.6M) Double-Sided	
80 Track	£409.00
80/40 Track	£489.00

### Floppy Disks

S/S D/D 40T	£1.80
D/S D/D 40T	£2.10
D/S D/D 80T	£2.90
3"	£4.50
Library Case (free library case with every 10 disks sold)	£2.00
70 Disk Cabinet	£22.00

## microFAST

57 HOXTON SQUARE, LONDON N1

OPEN FOR PERSONAL CALLERS FROM MONDAY TO SATURDAY, 9AM TO 6PM.

MAIL ORDER OR OTHER ENQUIRIES **01-729 1778** SAE for comprehensive Price List

### Computer Concepts ROMs

Disc Doctor	£32.00
Termi	£32.00
Graphics Rom	£32.00
Print Master	£32.00
Wordwise	£42.00

### Acorn Roms

View	£52.00
------	--------

### BBC Roms

Ultracalc	£65.00
-----------	--------

Full range of Software from A&F, Program Power, Computer Concepts, Level 9, Acornsoft always available at discount prices

### Supplies etc

Printer Cables	£12.00
- Extra quality	£15.00
Monitor Cables	£5.00
- CM14	£8.00
Ribbons	£
- Epson	£4.50
- KDC 2-shot	£7.00
- Daisystep	£4.00
- Juki	£2.00
Paper - 2000 sheets	£12.00

### Mail Order

Software/Firmware	FREE
Hardware	£10.00

# MAILING FLOPPY DISKS?

The Swan Disc Pack combines great strength with simplicity of use. Made from rigid white corrugated, it is a self assembly package providing high postal security at economical rates.

Free sample ring us on 01-607 9938



sizes:  
6 x 6;  
8.75 x 8.75

● Circle No. 134

## DISKS DISKS DISKS

\*\*\* LOWEST PRICES - FAST DELIVERY \*\*\*  
PRICE PROMISE

We will Better any lower delivered price advertised in the current issue of PC Please Telephone

### 5.25" DISKS - BOXES OF 10

	Prices per Box (£)			QTY	AMOUNT
	1-4	5-9	10-49		
DYSAN					
104/1 S/Slide S Dens 48tpi 40Tr	18.00	17.00	16.00		
104/1D S/Slide D Dens 48tpi 40Tr	20.00	19.00	18.00		
104/2D D/Slide D Dens 48tpi 40Tr	25.00	27.00	26.00		
204/1D S/Slide Q Dens 96tpi 80Tr	28.00	27.00	26.00		
204/2D D/Slide Q Dens 96tpi 80Tr	34.00	33.00	32.00		
VERBATIM DATALIFE (Five year warranty)					
MD525-01-HR S/Slide S or D Dens 48tpi 40Tr	15.25	15.00	14.50		
MD550-01-HR D/Slide S or D Dens 48tpi 40Tr	21.50	20.75	19.50		
MD577-01-HR S/Slide D or Q Dens 96tpi 77/80Tr	22.00	21.25	20.00		
MD557-01-HR D/Slide D or Q Dens 96tpi 77/80Tr	28.00	27.50	26.00		
10 or 16 hard sectors at same price. Add £1.00 for Plastic Case. Free Hi/CleanKit worth £6.40 with every box "Soft Sector" while stocks last					
VERBATIM VEREX (One year warranty)	14.25	13.75	13.25		
MD200-01 Soft Sector uninitialised					
MEMOREX	14.50	14.25	13.75		
3431-HR S/Slide S Dens 48tpi 40Tr	14.80	14.50	14.00		
3431-HR S/Slide D Dens 48tpi 40Tr	20.50	19.75	19.00		
3431-HR D/Slide D Dens 48tpi 40Tr	23.00	22.25	21.50		
3504-HR S/Slide Q Dens 96tpi 80Tr	25.00	24.25	23.25		
3501-HR D/Slide Q Dens 96tpi 80Tr					
BASF (Qualimetric) - Special Offer					
1X S/Slide S Dens 48tpi 40Tr	14.60	14.20	13.80		
1D S/Slide D Dens 48tpi 40Tr	18.30	17.75	17.20		
2D D/Slide D Dens 48tpi 40Tr	21.50	20.75	19.50		
ACCESSORIES	14.90	14.50	14.00		
HCK5 head Clean Kit with Fluid	1.90	1.80	1.70		
LCS 5.25 Library cases ECLY	13.50	13.00	12.50		
LB85-5 Lockable Box 40 Cap inc Disk Pen	16.50	16.00	15.50		
VCR-5 Verbatim 5 in head clean kit	6.40	6.20	6.00		
VCD-5 Verbatim 5 in H/c disks (per 10)	12.80	12.30	12.10		
LB20-5 Compact Ring binder 20 Cap	4.25	4.00	3.75		
SONY 3.5" DISKS	37.00	36.00	36.00		

### 8" DISKS - BOXES OF 10

Phone for Most Competitive Prices for Verbatim, Basf, Memorex and Accessories.

POSTAGE/PACKING (UK)

5.25 Disks/Clean Kit £1/Box\* (75p/Box 5+, 50p/Box 10+)

Library Case £2.50/Box (£2/Box 5+, £1/Box 10+)

Lockable Box \*Add 30p/Box for 1st Class

Please contact us for Quantity Discounts (50+ Boxes) and Trade Accounts. Official orders accepted from Government and Educational Establishments.

Name ..... Tel. No. ....

Address .....

Access/Barclaycard/Cheque No. ....

If you do not wish to cut out form send order separately

34 Cannonbury Avenue, Pinner, Middx HA5 1TS  
Telephone orders any time - we do the rest - 01-868 9548



Pinner Wordpro



● Circle No. 135

# HEALTHCARE FOR YOUR HARDWARE

When your Commodore 64 seems distinctly unwell it's hard to know what to do.

Which is why you need 64 Doctor.

This special program will find the fault by a series of short diagnostic tests. And tell you exactly where the problem lies.

Included are tests for RAM, keyboard, disc-



drive, joysticks, datacassette, printer, audio and video displays.

So as well as saving you pounds in having someone check through the whole system for a fault, 64 Doctor will give you peace of mind.

You can give your system a check-up by visiting any good computer store including selected branches of Laskys, W.H. Smith and Boots.



PRACTICORP

64 Doctor. Tape £17.95 inc. VAT. Disc £19.95 inc. VAT

Practicorp, Goddard Road, Whitehouse Industrial Estate, Ipswich IP1 5NP. Tel: 0473 462721

● Circle No. 136

# Isn't it time you stopped running your computer at printer speed?

*In ten seconds, your computer can output enough print data to keep your printer busy for five minutes, or longer.*

*Instead of waiting around for the printer, you could install a print buffer, and free your computer for its next task in seconds.*

*Print buffers take care of the printing — and the waiting. And the more you print, the more time a buffer will save.*

*Buffers for any combination of micro and printer/plotter. Internal buffers for Epson printers; Apple Computers. 'In-line' buffers for IBM PC, Sirius, Commodore 20/40/80 series, Super Brain, BBC, Tandy, etc.*

*Data transfer in RS232c serial, Centronics-parallel, IEEE-488 formats. Protocol conversion. RAM sizes from 2K to 256K.*

## A-Line Computer Systems

1 Church Farm Lane,  
Willoughby Waterleys,  
Leicestershire LE8 3UD.

Telephone:  
Peatling Magna (053 758) 486

**Talk to the specialists.  
We have the answers.**

● Circle No. 137

## Smooth, Cool & In Control

**The APPLE User's INSURANCE...**  
Protect your software investment and take steps to prevent costly, time-consuming errors NOW!

Your Apple is vulnerable to internal overheating and external mains-borne interference — either can induce malfunctions in the Apple's operating software, capable of wrecking data files and programs, losing days or even weeks of work.

Power-Core is your positive move to eliminate such problems. Designed to aesthetically complement and fit snugly on top of your Apple, Power-Core features:

- Mains Filtering for the Micro-Processor.
- High Air-Flow Cooling Fan.
- Additional Power Distribution.

(up to 6 Peripherals)

**ONLY  
£149.50  
INC P&P**

**Power-Core** is supplied complete with fitting instructions and all necessary plugs and cables.

A.S.C. products are fully Guaranteed for one year and covered by the A.S.C. money back if not satisfied offer. Return goods within 7 days post paid.

**\*NEW\***  
**MICRO NEAT**  
**ONLY £149.50 INC P&P**

A hi-spec Power Filtering & Distribution Unit, for use with ANY Micro system.

The heart of the Micro Neat is a sophisticated high performance line filter, designed for applications demanding maximum protection from local or remote mains borne interference. As well as high energy spikes. Achieved by combining a high performance broadband filter with transformer broad band filter circuit. Micro Neat is capable of delivering 2 (two) 10A/150 Can handle several critical systems assuring maximum protection to your local computer networks.

Features:

1. C.P.U. outlet switched separately.
2. Printer output switched separately.
3. Four auxiliary outlets operative when system switched on.
4. Security Mains Key Switch.

For the technically minded:  
Input 240v current 10A  
Operating temperature 25°C to +55°C  
Interference Attenuation  
= 100dB better than -50dB  
= 100dB better than -40dB  
= 100dB reduction from voltage transient reduction from voltage  
= 100dB better than -100dB

### ORDERING

Send your order, enclosing cheque P.O. for the total amount due, made payable to A.S.C. Ltd.

To pay by Access, send your Access No. and Cardholder details with order.



Allow 28 days for delivery

Address All Order to

**ASC**

Dept PCS 100111  
4a King Street, Mortimer,  
READING RG7 3RS, UK  
Telephone: (0734) 333100

● Circle No. 138

## SUSS BOX

The DUPLEX SUSS-BOX and DUPLEX SUSS-ADAPTOR have been designed to enable the less skilled computer user to have a better understanding of the correct working connection between a computer and a peripheral, such as a printer. This is achieved by using the commonly used signals (wires) of the RS232C serial data cable specification, a matrix block and special connector pins. By inserting the connector pins into the SUSS-BOX's matrix block at the axis of two incoming signals the user can quickly establish a firm connection. The signals are routed into the SUSS-BOX by two 25 way D type connectors, 1 x female, 1 x male. The SUSS-BOX also provides a lamp for each signal to show its condition when connected in-line, ie High or Low.

**£49.95  
+ £1.25 p&p  
+ VAT**

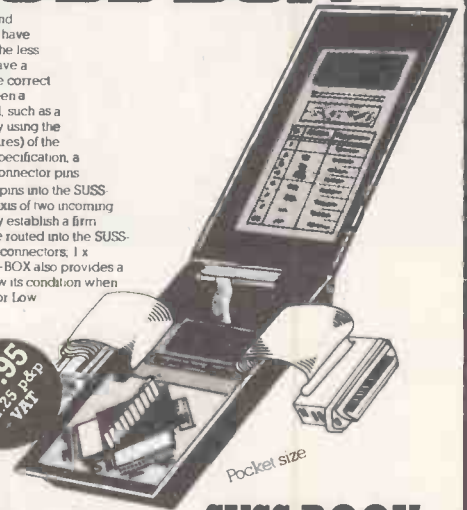

### SUSS-ADAPTOR

When the user has achieved the correct 'Pin out' between a micro computer and a printer the DUPLEX SUSS-ADAPTOR should be used as a permanent means of connection. This is done by 'transposing' the correct matrix block pin layout already established with the SUSS-BOX onto the matrix block of the SUSS-ADAPTOR, and then installing the SUSS-ADAPTOR in between the computer and printer.

**£29.95  
+ £1.00 p&p  
+ VAT**

**DUPLEX**  
Communications  
*The Interface People*

South - 52 High Street, Stock, Essex CM4 9BW, Tel 0277 841011

Midlands/North - 2 Leira Lane, Duxton Bassett, Nr. Lutterworth, Leicestershire LE17 5JP, Tel 0455 284398

All prices are based on cash-with-order terms

## SUSS BOOK

2nd edition

If the user specifically wishes to connect a microcomputer to the OCTET or HERMIT typewriter/printer then refer to DUPLEX'S SUSS-BOOK for details on various microcomputer cable Pin-outs.

**£6.95  
+ £0.65  
+ p&p**

● Circle No. 139



# The SV-328 just goes on growing...



With sophisticated 3-channel ADSR sound, high resolution sprite graphics and a rapidly expanding library of software, the Spectravideo SV 328 is all you'd expect in a great games machine.

A slick word processor-style keyboard, CP/M\* compatibility and massive RAM (expandable to full 144K) puts it in the business league.

And for keen programmers, the easy-to-use and space saving extended BASIC gives total control of all standard functions.

There's room to grow too – with a complete range of peripherals already available, including some of the best joysticks in the business.

At £262 the SV328 is great value for money!

**Spectravideo SV 328:** Memory – 32K ROM expandable to 96K, 80K on board RAM expandable to 144K; Keyboard – full word processor type, 87 keys, 10 function keys, built in cursor control; Graphics – 16 colours, 256x192 high resolution graphics, 32 sprites; Sound – 3 channels, 8 octaves per channel; CP/M\* compatibility – to over 3000 existing software packages; Storage – cassette drive, 256K disk drive capacity. Suggested retail price – £262.

**Spectravideo SV 318:** Suggested retail price – £186.

**Spectravideo Peripherals:** Cassette Drive; Disk Drive – single; Disk Drive – double; Disk Drive – full Business Pack; Mini Expander; Super Expander; Monitor; Printer with Interface Card; Centronics Interface; RS 232 Interface; 16K RAM Pack; 64K RAM Pack; 80 Column Card; Coleco Adaptor; Quick Shot Joysticks.

Fill in the coupon today and we'll mail you a full technical brochure and latest test reports of the amazing Spectravideo range, or see it for yourself at DG Leisure Centres and most leading computer stockists.

\*CP/M is a registered trade mark of Digital Research Inc.



Tomorrows Computers – Today

Spectravideo Ltd, 165 Garth Road, Morden, Surrey SM4 4LH  
Telephone: 01-330 0101. Telex: 28704 MMH VANG

To: Spectravideo Ltd, 165 Garth Road, Morden, Surrey SM4 4LH

I am interested in Spectravideo computers and peripherals. Please send me the latest reports together with a full technical specification brochure.

Name: \_\_\_\_\_

Address: \_\_\_\_\_

Tel. No.: \_\_\_\_\_ STD Code: \_\_\_\_\_

PC7/84

● Circle No. 237

# DISK GAMES FOR THE COMMODORE



If you've got a 1541, you don't want to spend ages waiting for cassette games to load. Freed from the restraints of loading times, Audiogenic Disk Games can give you typically around 30K of machine code! More code means better games, better graphics and sound, more variation, and those little extra touches that you will come to expect from a game.

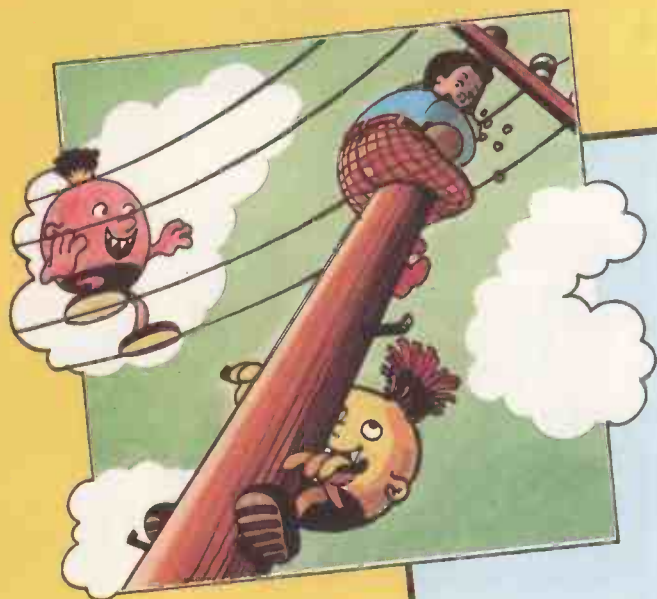

## FRANTIC FREDDIE

Frantic Freddie is fun all the way! Played to an unbelievable soundtrack of brilliantly arranged tunes, Frantic Freddie contains all the ingredients that make a game into a classic! Freddie is a telephone line engineer who has to climb up and down the telegraph poles, picking up pots of gold and avoiding the dreaded Greeblies. The Greeblies take on a different form with every new screen, but one thing's for sure - they may look cute, but they show no mercy! Frantic Freddie also features wacky messages, funny interludes and silly bonuses. Frantic Freddie - a game with a sense of humour!



SS016

## PEGASIS

SS017

Pegasus takes us back to the mythical age when the battle between Good and Evil was fought by heroes on winged steeds. As the champion of the forces of Good, you must topple the evil Black Warriors from their jet black flying horses by swooping down on them from above, then land and finish them off before they can remount. In order to keep airborne, you must keep your wings flapping with the joystick Fire button, and control direction with the stick. The brilliant programming of Pegasus gives you stunning graphics, bonus creatures, great wing flapping sound effects, an incredible simulation of flying horse aerodynamics, plus - two players can play at the same time!



AT YOUR DEALER NOW £12.95

LOOK OUT TOO FOR THESE AMAZING TITLES ON DISK -  
**FORBIDDEN FOREST, AZTEC CHALLENGE and SLINKY!**

Audiogenic LTD

# DON'T DEAL WITH THE REST, DEAL WITH THE BEST

# ATA The market leaders!...

Call for the very latest prices!

01-833 0044

Apple IIe .....	£499.00
Apple IIc .....	£899
Apple Macintosh .....	£1750
Apple III .....	£1890

### ATA IS EXPANDING!

Geographically and our product range. We can supply the complete range of hardware and software for Apple, Apricot, Sirius, Hewlett-Packard and IBM peripherals.

Do you sell micros successfully? If so we would like to talk to you. Ring Ann Rossi (0727) 34361 Export specialists — ring or telex for details!

Export specialists — ring or telex for details

## ...with recognised professional support



### Apple Hardware

Apple IIe .....	499
Apple IIc .....	899
Macintosh .....	1750
Apple III .....	1890
Disk Drive IIe + Controller .....	250
Disk Drive IIc - Controller .....	199
Disk Drive IIc .....	219
Disk Drive Macintosh .....	339
Apple Monitor IIe .....	130
Apple Monitor IIc .....	130
12" Hi-Res Green Display .....	99

### Printers

Imagewriter 10" carriage .....	345
Imagewriter 15" carriage .....	495
Imagewriter Accessory Kit IIe .....	36
Apple Daisy Wheel Printer .....	1170
Epson RX80 100 Cps .....	245
Epson RX80 FT .....	282
Epson RX100 .....	399
Epson FX80 160 Cps .....	349
Epson FX100 160 Cps .....	499
Ricoh 1300 Flow Writer .....	1150
Ricoh RP1600 .....	1499

### Plotters

Hewlett-Packard HP7470 .....	750
Hewlett-Packard HP7475 .....	1399

### Accessories

Apple 80 Col Card .....	75
Apple 80 Col Card Extended .....	175
IEEE — 488 Interface card .....	325
Parallel Interface Card .....	95
Super Serial Card .....	105
Joystick IIc .....	39
Numeric Keypad IIe .....	85
Apple Mouse II .....	120
Microsoft Card (280 CP/m) .....	219
Keyzone Parallel Card .....	54
Keyzone Serial Card .....	82
Keyzone 80 Col Card IIe .....	45
Keyzone 80 Col Card Ext IIe .....	79
Keyzone Fan with Antisurge .....	38
Accelerator Card .....	289
Grappler + .....	105

Whole range of other products available!

PRICES EXCLUSIVE OF VAT AND CURRENT AT TIME OF PRINTING.

### Apricot Memory Boards

640k ram board upgradable from 256k .....	
Simon Card 256k Memory .....	249
Simon Card 512k Memory .....	925
Simon Card 640k Memory .....	999
Ms-Dos Ram disk Software .....	45

### Sirius/Vector Memory Boards

All Boards expandable to 384k .....	
Simon Card 256k Memory .....	185
Simon Card 512k Memory .....	269
Simon Card 640k Memory .....	329
Ms-Dos Ram disk Software .....	45

### IBM PC/XT Memory Boards

Ram boards with asynchronous serial port .....	
All boards expandable to 256k .....	
Simon 64K+ .....	169
Simon 128k+ .....	199
Simon 192k+ .....	249
Simon 256k+ .....	289

### Macintosh

Macintosh the ultimate business machine.  
32-bit MC68000 microprocessor  
400 kilobyte 3 1/2 inch disk  
The Mouse Replaces typed-in computer commands with a form of communication you already understand: pointing  
Nine-inch high-resolution (512 x 342-pixel) bit-mapped display  
RAM 128 kilobytes  
ROM 64 kilobytes  
Completely portable

**PRICE £1750**

### IBM Peripherals & Software

Wordstar .....	270
Multimate .....	299
Select .....	320
QBase .....	105
dBase II .....	350
Friday .....	160
Cardbox .....	175
PFS .....	85
PFS Report .....	85
PFS Write .....	80
Lotus 1-2-3 .....	355
Tkl Solver .....	205
Supercalc I .....	125
Supercalc II .....	185
Supercalc III .....	259
Visicalc .....	159
CPM/86 .....	39
Personal Basic .....	95

### BARGAIN BOX

We have a selection of demonstration hardware and software for sale.

HP-125 Personal Office Computer .....	1508
HP-86A .....	1340
HP-87 .....	2300
HP-87/XM .....	2343

**25% OFF ABOVE PRICES**

WE ALSO STOCK APPLE, HEWLETT PACKARD AND APRICOT

### TERMS AND CONDITIONS

For delivery please add  
£0-£199 + £5, £200-£1499 + £13,  
£1500 + 1 1/2%.

ATA — WALES Cwrt-Y-Gaer, Wolvesnewton, Gwent, NP6 6PR, Wales, 02915-374

ATA — SCOTLAND 4 Ruthersford Square, Brucefield Industrial Park, Livingston, Scotland EH54 9BV, 0506 417277

ATA — LONDON 4 Albion Hse, 1 Back Hill, London EC1. 01-833 0044 Telex 25102 CHACOM G

ATA — ST ALBANS Adelaide House, 9 Adelaide St, St Albans, Herts AL3 5BE. (0727) 34361

ATA — SHEFFIELD 72 Eldon Street, Sheffield, S1 4GT. (0742) 700802

FREEPOST SHEFFIELD S1 1AY

### CHEQUES WITH ORDERS

Please allow 10 days for clearance. PLC's, public sector etc 30 days credit available on official orders, subject to 5% credit charge.



Order your  
**Macintosh™**  
NOW TO ENSURE DELIVERY



# PICK A CARD ...ANY CARD

Every card's a winner. The versatile 80-Bus system can be used for a host of applications: Process Control, Batch Counting, Robotics, Colour Graphic Displays, CAD/CAM, CNC; In Manufacturing, Telecommunications, Instrumentation, Laboratory Testing, Security Systems, Plant Control, Data Collection and Distribution.

Also, in smaller companies it can handle Accounts, Payroll, Wordprocessing, Stock Control, Program Compilation and Data Base Management... whilst still being able to run specialist applications.

And because there is no wasted capacity with a Gemini, a system can cost a good deal less than you might think.

With Gemini you can buy a complete system, upgrade your existing 80-Bus system, or build your own.

So when you've had a look at the pack of cards below, plug yourself into our dealer network to discover how opening a new pack of cards with Gemini will help you pick a winner.



These represent just a small selection from the range of over 25 cards.

**GM813 CPU/64K RAM BOARD** - This card provides system 4 MHz, Z80 CPU, 64K user RAM and both serial and parallel I/O.

**GM811 CPU BOARD** - An industrial standard 4 MHz, Z80 controller board with parallel and serial I/O together with a variable Byte-wide memory capacity.

**GM888 CPU BOARD** - A new card featuring the Intel 8088 processor to provide a dual processor system.

**GM832 SVC BOARD** - Provides conventional 80 x 25 or 40 x 25 screen format together with graphics capability. Includes full keyboard support and overseas character sets.

**GM862 256K RAM BOARD** - Supports both page mode and extended addressing facilities and can be used with all of the Gemini CPU cards.

**GM833 512K RAM-DISK BOARD** - Provides 'pseudo disk' facility in a MultiBoard system.

**GM829 FDC/SASI BOARD** - Combines floppy disk controller and SASI board supports up to four floppy disk drives plus Winchester controller cards.

**GM837 COLOUR GRAPHICS BOARD** - 256 X 256 sixteen colour graphics display. Output to either PAL UHF or RGB.

**GM816 MULTI I/O BOARD** - Provides three Z80A PIO devices plus CTC and battery backed Real Time Clock.

**GM848 SERIAL I/O BOARD** - Utilises two Z80A SIO chips providing four synchronous/asynchronous serial channels with software selectable baud rates.

**GM836 NETWORK INTERFACE BOARD** - Provides RS422 communication protocol for networking CPU boards.



Gemini Microcomputers

**The dealer's choice**

Gemini Microcomputers Ltd., 18 Woodside Road, Amersham, Bucks, England HP6 0BH. Tel: (02403) 28321. Telex: 837788

● Circle No. 142

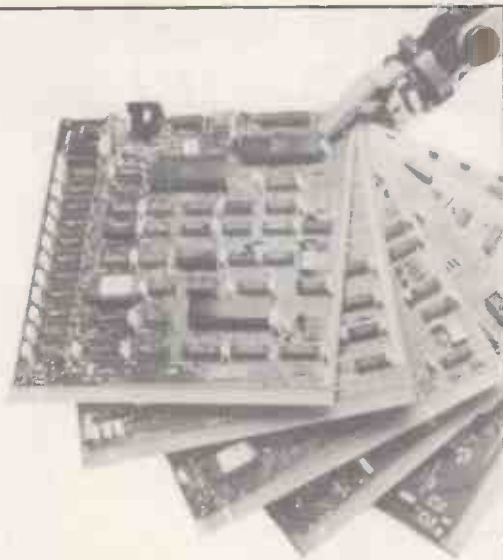

The Microvalue Group dealers shown below represent part of the Gemini network.

For expert advice and full details on the Gemini System, contact your nearest dealer today.

**AMERSHAM COMPUTER CENTRE LTD**  
18 Woodside Road, Amersham, Bucks HP7 0BH  
Tel: 02403 22307 Telex: 837788

**BUSINESS & LEISURE LTD**  
16 The Square, Kenilworth, Warwickshire CV8 1ED  
Tel: 0926 512127

**CENTIFLEX MICROSYSTEMS LTD**  
Unit 6, Perry Road, Staple Tye, Harlow, Essex CM18 7NW  
Tel: 0279 442233

**ELECTROVALUE LTD**  
28 St. Judes Road, Englefield Green, Egham, Surrey TW20 0HB  
Tel: 07843 3603 Telex: 264475

**E.V. COMPUTING**  
700 Burnage Lane, Manchester M19 1NA  
Tel: 061-431 4866

**HENRYS RADIO**  
404 Edgware Road, London W2  
Tel: 01-402 6822

**LEEDS COMPUTER CENTRE**  
55 Wade Lane, Merrion Centre, Leeds LS2 8NG  
Tel: 0532 458877

**OFF RECORDS LTD**  
Computer House, 58 Battersea Rise, Clapham Junction, London SW11 1HH  
Tel: 01-223 7730

**PARKSTONE ELECTRONICS LTD**  
18 Station Road, Lower Parkstone, Poole, Dorset BH14 8UB  
Tel: 0202 746555

**SKYTRONICS LTD**  
357 Derby Road, Nottingham NG7 2DZ  
Tel: 0602 781742

**TARGET ELECTRONICS LTD**  
16 Cherry Lane, Bristol BS1 3BG  
Tel: 0272 421196

**NEWBURN ELECTRONICS LTD**  
58 Manse Road, Ballycarry, Carrickfergus, N. Ireland BT38 9LF  
Tel: 09603 78330



**INTO-TOUCH LIMITED<sup>TM</sup>**  
**ANNOUNCES NEW LOW COST**  
**TOUCH TECHNOLOGY**

**CAN BE APPLIED TO:**

- **Personal Computer Monitors**
- **Public Information Systems**
- **Point of Sale Devices**
- **Flat Screen Displays**
- **Keyboard-Less Control Panels**
- **Educational Systems etc.**

**The technology is tough, reliable and offers 100 × 100 continuous co-ordinate resolution.**

**Does not use capacitance, infra red or plastic panel overlays.**

**Get "INTO-TOUCH" on**  
**01-940 4910**

# LONDON COMPUTER CENTRE



## olivetti M24

Compatible & faster than IBM PC  
2 Drive System 128K **£1,939**  
10Mb Hard Disk (XT) **£3,899**  
\*Built-in Graphics & Colour  
\*Runs Flight Simulator, Lotus 1-2-3 on mono or colour  
\*7 IBM slots  
\*8 Mhz 8086 true 16 bit

## NEC

16 bit 8086 128K RAM  
2.4 Mb Disk storage  
CP/M86 or MSDOS  
Green Screen  
Colour Display



**£1,985**  
**£2,595**



## apricot

5/10Mb Hard Disk **£2,695/£2,995**  
Standard Floppy Version  
from **£1,495**

## siurus 1

1.2 Mb Disk storage **£2,195**  
2.4 Mb Disk storage **£2,895**  
10 Mb Disk storage **£3,995**



## SANYO

IBM COMPATIBLE  
16 bit  
runs most non-graphic software

8088 CPU. 128K RAM (expandable to 256K) MSDOS  
550 1 Drive 160K **£749**  
\*550/2 2 Drives 160K ea. **£875**  
555 2 Drives 160K ea. **£900**  
\*550/2D. 2 Drives 360K ea. **£999**  
\*555/2D. 2 Drives 360K ea. **£1,295**  
550/QD 2 Drives 720K ea **£1295**  
555/QD 2 Drives 720K ea **£1550**

\*LCC upgrade  
Free Wordstar & Calcstar with 550  
Free Wordstar, Calcstar, Mailmerge, Spellstar & Infostar with 555  
Sanyo Monitor mono **£125**  
Sanyo Monitor colour **£499**

### LCC SPECIAL BUNDLE

NEC APC RRP **£1,985**  
Dot Matrix Printer RRP **FREE**  
Cables RRP **FREE**  
**You pay £1,985**

#### Northstar Dimension

The IBM compatible multi-user system  
(up to 13 users)  
15Mb hard disk and 2 user stations  
complete with VDU running IBM graphics

Each subsequent work station  
(8088 CPU 128K RAM) **£5,375\***  
**£1,275**

#### CHAMELEON IBM Compatible £1995

with 9" Screen, 2 X 360K Drives  
Colour and Mono inbuilt.  
FREE Perfect Writer, Speller, File, Calc.  
Super Calc 3, MSDOS GW basic Z80 CP/M  
TMS Illustrator Comms. Package

### LAP PORTABLES

NEC 8201 16K **£475**  
EPSON HX20 16K from **£402**  
TANDY 100 8K **£433**

### DOT MATRIX PRINTERS

CANON 80 Col 160cps **£319**  
CANON 156 Col 160cps **£399**  
GEMINI 10X/15X 120cps **£249/359**  
EPSON FX80/FX100 160cps **£437/£569**  
RADIOHACK (TOSHIBA) 2100 **£1,130**  
BROTHER HR/15/25 **£445/£795**

### DAISYWHEEL PRINTERS

FLOWWRITER 1600 60cps **£1,600**  
TEC F10 40cps **£1,050**  
Tec F1500 25cps **£450**  
JUKI 18cps **£449**

### SHEET FEEDERS

BDT 2 Tray Auto **£595**  
BDT 3 Tray Auto **£695**  
BDT Single **£375**  
Juki Sheet Feeder **£239**  
Juki Tractor Feeder **£99**  
Tractors (Qume RICOH, Tec) **£139**

### HARD DISKS

Hard Disks for IBM PC Sirius QX10, NEC  
10 Mb **£1,545**  
15 Mb **£1,695**  
20 Mb **£1,995**  
10 Mb Tape Streamer IBM PC **£995**

### PLOTTERS

Hewlett-Packard 74754A 6 Pen **£1,401**  
Roland DXy 800 A3, 8 Pen **£ 520**

### MODEMS/MONITORS

Buzz Box. Direct Connect Modem **£70**  
Sendata Acoustic Coupler **£220**  
Philips 12" Green. Hi Res **£85**  
TAXAN 12" RGB Hi Res **£399**

### ACCESSORIES

Floppy Disks Printer Buffers  
Daisywheels Paper  
Ribbons Labels  
Cables Computer cleaning kits  
Disk containers Acoustic Hoods

## SOFTWARE 8/16 Bit

### The comprehensive range includes

WORDSTAR £235  
SUPERCALC II/III £190/£275  
WORD PROCESSING £  
Spellbinder 290  
Peach Pack\* 332  
Mutimate 332  
Spellstar 134  
Mailist 50  
Grammatik 85  
FINANCIAL PLANNING  
Plannercalc 85  
Multiplan 170  
Lotus 1-2-3 357  
D BASE CORNER  
FastBase 150  
Autocode 195  
Quickcode 205  
Dgraph 190  
Friday 185  
Infostar 266  
DMS 400  
UTILITIES  
Sid £60, ZSid £76,  
Mac £133

D BASE II £349  
SPELLING CHECKER £80  
LANGUAGES £  
MBasic 215  
MBasic Compiler 235  
C Compiler 330  
Fortran 80/86 325  
Cis Cobol/Forms2 399/105  
Pascal MT 240  
Pascal MT +\*SSP 350  
ACCOUNTING  
Pegasus from 250  
Peachtree from 325  
Sage 375  
Exact 750  
Pulsar from 195  
COMMUNICATIONS  
Bslam 130  
Crosstalk 135  
Moveit 80/86 90  
\*Incl. PeachSpell/Mallist  
Please telephone for the LCC  
Software Catalogue

FORMATS: Superbrain, Televideo, Sirius, Sanyo, Osborne  
Northstar, 8" SD, DEC, Epson QX-10, IBM  
ICL, H-P, XEROX, ALTOS, Apricot, NEC-APC & many more  
All prices are exclusive of VAT

Looking for an easy-to-use cost effective  
File Handling System?

Thank god it's  
*Friday!* **£185**  
by ASHTON-TATE

Friday will take care of your Files, Reports, Diary,  
Mailing and much more. It enables electronic files to  
be set up. Reports can be displayed and retrieved fast  
from all or part of a file. Friday is fast and versatile. It is  
designed for beginners.

Friday enables you to prepare custom reports  
to suit your requirements and presentation.  
Friday enables you to sort and select any field.

Friday uses on screen prompts and help  
menus to guide you through the job  
you are doing.

**43 Grafton Way, London W1P 5LA (Opposite Maples)**  
**Opening Hours: 10-7 Mon-Fri. 12-4 Sat.**  
**01-387 4455 (4 lines) Telephone Answering Service After Office Hours**  
**Telex: 8953742**

**DEMONSTRATIONS**  
**SALES-SERVICE**  
**SUPPORT**

# HP GYPSY

Hewlett-Packard's true lap portable is due to surface in the U.K. later this year. Glyn Moody checks it out.

THE LAUNCH of Hewlett-Packard's HP 150 touch-screen computer reviewed in the May issue of *Practical Computing* signalled the start of a full-scale attack by HP on the business and professional micro market. In the wake of the HP 150's apparent success, HP has made no secret of the fact it will be launching a series of micros aimed at this burgeoning sector, with particular emphasis on the lap-portable to trans-portable range.

The first of these, a lap portable, has been released in America, and is due to surface in the U.K. later this year. Originally called the HP 110, it wandered around HP as Nomad for a while before becoming the Gypsy.

The Gypsy adopts the increasingly popular flip-top style where the 16-line by 80-character LCD folds down on to the keyboard when the machine is packed away. At the back of the machine there is an HPIL interface, allowing low-power units such as a 3.5in. disc drive to be daisy-chained directly to the Gypsy, a standard HP battery-charger socket, an RS-232 and a modem port. In the U.S. the Gypsy is equipped with an internal modem; in the U.K. a battery-powered acoustic coupler will be available, at least until BT approval is obtained for an integral modem.

## Up-to-date

At the heart of the machine is an 8086 running at 5.33 MHz, using the latest low-power CMOS technology. In addition to 272K of RAM, which can be partitioned into user RAM and an electronic disc, there is a massive 384K of ROM. Part of this is taken up with an impressive array of bundled software: Lotus 1-2-3, HP's Memomaker word processor, a terminal emulation package, MS-DOS and the Personal Applications Manager, Pam, which was described in May's review.

The Gypsy manages to pack most of the features of the 150, except the touch screen of course, into a machine weighing only 6½lb. Pam acts as an outer shell to MS-DOS and application packages, providing a consistent and user-friendly front end. Command options are located in eight function boxes at the foot of the screen. The touch screen model allows the to be selected by pointing, whereas the Gypsy uses the eight function keys at the top of the keyboard.

The keyboard offers most of the extended characters on the HP 150, including character/line insertion and deletion, and page scrolling. Unfortunately



the keys themselves are very shallow and in continuous text entry your hands soon become tired.

The machine is turned on by pressing any key. In fact the micro circuitry is left permanently running: only the screen draws appreciable power. It is claimed that the battery will last a year when the machine is not in use, and that it provides sufficient power for 20 hours of continuous operation. There is an on-screen indication of the percentage of power remaining. One neat feature is that the Gypsy switches off the screen automatically after a preset period adjustable from 30 seconds to 30 minutes, and any key will reactivate it.

Since the chips remain permanently powered, the RAM can be used as an electronic disc to store programs per-

manently; an on-board battery provides backup. In this state it is addressed as drive A:, and the ROM is drive B:. The fast disc access coupled with the 5MHz 8086 helps to provide speedy response times. Memomaker, which was reviewed along with the HP 150 in May, and Lotus 1-2-3 work surprisingly well on the limited screen size, though bold and underline enhancements resort to WordStar-like control characters rather than offering WYSIWYG.

HP sees the Gypsy as aimed at travelling executives and particularly at customised markets. In this respect, the new portables will be a natural development of the customised calculators widely used in business and industry. HP will also supply boards for IBM and HP micros which allow direct downloading from the Gypsy.

## Specification

CPU: 8086 running at 5.33MHz  
 RAM: 272K, partitionable into electronic disc  
 ROM: 385K  
 Display: 16 lines by 80 characters  
 Keyboard: QWERTY, eight function keys, numeric keypad  
 Interfaces: HPIL, RS-232  
 Dimensions: 254mm. (10in.) x 330mm. (13in.) x 73mm. (3in.)  
 Weight: 2.95kg. (6½lb.)  
 U.K. price: probably about £2,000  
 U.K. distributor: Hewlett-Packard Ltd, Personal Technical Computers, Eskdale Road, Winnersh, Wokingham, Berkshire, RG11 5DZ. Telephone: Crowthorne (0344) 773100

## Conclusions

- The Gypsy is hot technology: its CMOS chips mean real computing power that is fully portable.
- The keyboard lets down a generally very highly engineered product. The screen is no better and no worse than most LCDs.
- The Gypsy will not be cheap at probably about £2,000, though this does include some useful bundled software.
- As a practical proposition for the travelling executive, it should work well. Pam is an effective solution to the user interface problem.
- At 6½lb. it is truly portable; adding disc drives and acoustic couplers will make it less so.

£295

# ESSPLOT 2

THE GRAPHICS PACKAGE AVAILABLE ON  
 IBM PC, APRICOT, DEC RAINBOW AND OTHER INTEL 8088/86 MACHINES  
 Requires MS-DOS and 256k bytes of Memory

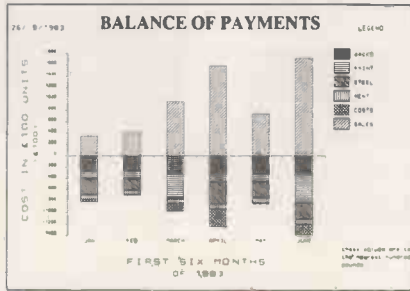

**BAR CHARTS**

- \* STACKED BAR CHART
- \* SIDE BY SIDE
- \* THREE DIMENSIONAL
- \* SPLIT AND LINE
- \* UP TO 20 BARS
- \* UP TO 6 VALUES EACH

**DATA FILES**

- \* DIF, MULTIPLAN LINK AND ASCII

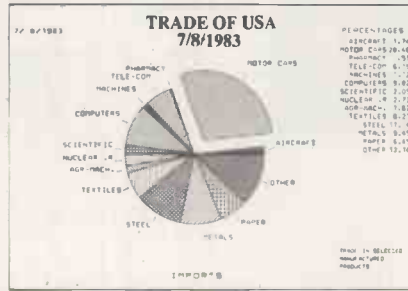

**PIE CHARTS**

- \* UP TO 4 PIES PER CHART
- \* 20 SLICES PER PIE
- \* PERCENTAGES

**SLIDE SHOW**

- \* FULL SLIDE SHOW FACILITIES

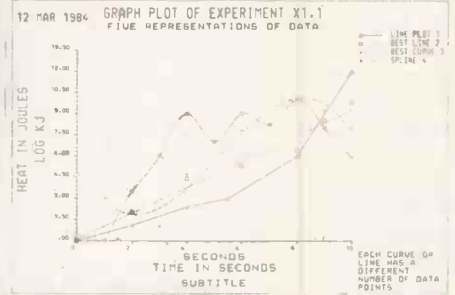

**GRAPH PLOTS**

- \* SPLINE CURVE
- \* BEST CURVE
- \* BEST LINE
- \* SHADED LINE PLOT
- \* SCATTER PLOT
- \* 6 LINES/CURVES
- \* LINEAR/LOG/NLOG SCALES

**INTERFACES**

- \* COLOUR CARDS eg PLUTO
- \* A RANGE OF GRAPHICS PRINTERS

£895

# ESS 2D

THE CAD PACKAGE FROM ESS CONSULTANTS

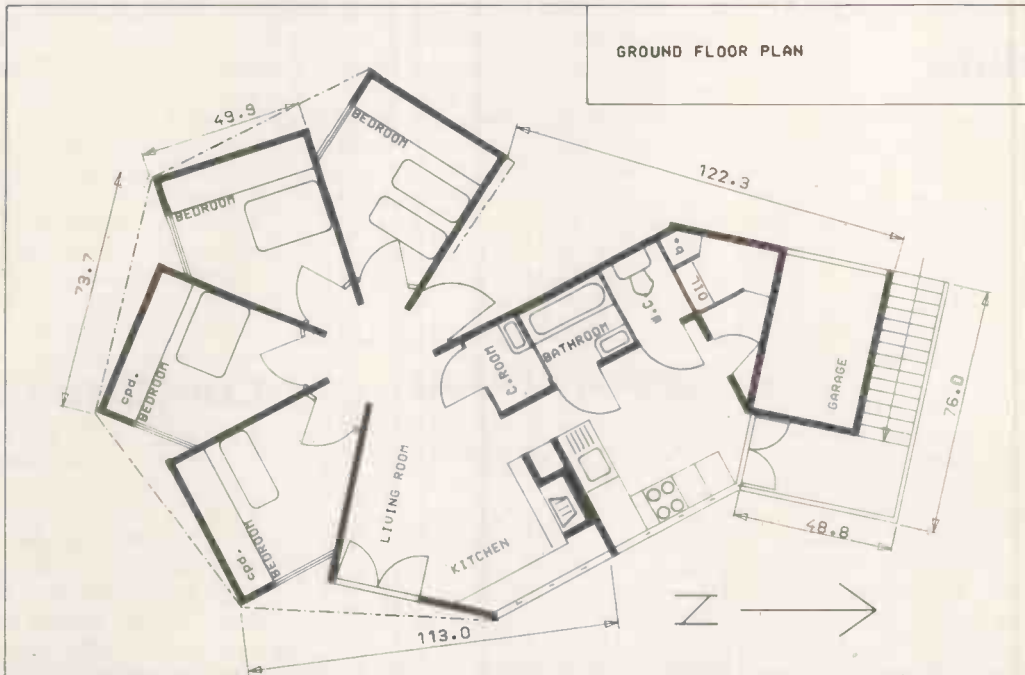

**PLOTTERS**

HEWLETT PACKARD: GOULD BRYAN: C-ITOH: WATANABE: TEKTRONIX: HILOT: CAL-COMP: NICOLET ZETA: DIGILOT: MANNESMAN TALLY: ROLAND.

All enquiries including Dealers/Distributors to:

**ESS CONSULTANTS LTD.** 35 CHENEY WAY, CAMBRIDGE.  
 TEL: (0223) 351196





# DIRECT DISK SUPPLIES

OUR NAME SPEAKS FOR ITSELF



**DDS VALUE FOR MONEY PRICES**  
**FAST DISK DELIVERY — CHEAPEST PRICES**

## DDS PRICE MATRIX

Easy pricing. Use the DDS Price Matrix for the right price first time. Or DIAL-A-DISK, for firm quoted prices.

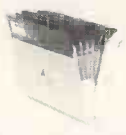
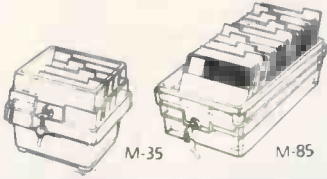
	3M			Verbatim® Datalife 5 year warranty			maxell®		
5.25" single sided disks	Code	1-9 boxes	10+ boxes	Code	1-9 boxes	10+ boxes	Code	1-9 boxes	10+ boxes
double density 48tpi	744	14.99	13.99	525	17.99	15.99	MD1-D	22.99	20.99
quad density 96tpi	746	22.99	20.99	577	24.99	22.99	MD1-DD	30.99	28.99
5.25" double sided disks	Code	1-9 boxes	10+ boxes	Code	1-9 boxes	10+ boxes	Code	1-9 boxes	10+ boxes
double density 48tpi	745	21.99	19.99	550	25.99	23.99	MD2-D	30.99	28.99
quad density 96tpi	747	26.99	24.99	557	32.99	30.99	MD2-DD	41.99	39.99
p&p per 10 disks		.75	FOC		.75	FOC		.75	FOC
8" diskettes	Code	1-9 boxes	10+ boxes	Code	1-9 boxes	10+ boxes	Code	1-9 boxes	10+ boxes
s'gle sided s'gle density	740.0	22.99	22.49	FD34-9000	25.99	24.79	FD1-128	26.09	25.49
s'gle sided d'ble density	741	29.99	29.09	FD34-8000	26.49	25.59	FD1-XD	29.09	28.49
d'ble sided d'ble density	743.0	34.49	33.49	DD34-4001	30.99	30.19	FD2-XD	37.39	35.89
p&p per 10 disks		1.50	FOC		1.50	FOC		1.50	FOC
See-10 library box		1.99	1.75						
p&p per See-10		.75	.30						
ABA lockable boxes									
M35 — 40 disks		13.99	12.99						
M85 — 80 disks		16.99	15.99						
p&p per ABA box		1.75	FOC						
(Carriage at cost on 3-9)	SEE10								



**Sony 3.5" Disks** From £38.99  
**Memorex 3.5" Disks** per box of 10  
**Maxell 3" Disks** plus p&p 75p

All offers and prices subject to change without notice.

Direct Disk Supplies Ltd., 29 Dagmar Road, Kingston, Surrey KT2 6DP

Prices per box of 10 disks excluding VAT

### HOW TO ORDER:

1. Complete the coupon and post with your cheque using our FREEPOST address. A first class stamp gets it to us next day.
2. Urgent orders: DIAL-A-DISK 01-541 1144. Dictate your order with ACCESS or VISA and they're as good as received.
3. Collect from our office, phone and they will be waiting for you between 10.00 and 17.00 weekdays. (Other times by arrangement).
4. Next day delivery £7.50.
5. Crucial Orders: Same day delivery by quotation.
6. Official Orders: Orders from Government Departments, Local Authorities, Universities, Schools, etc, are very welcome and receive immediate attention.
7. Telex Orders: To 932905 (Larch G) attention LAN.

To: Direct Disk Supplies Ltd., FREEPOST, 29 Dagmar Road, Kingston, Surrey KT2 6BR.

PC7/84

Code	Qty	Description	Price

Name \_\_\_\_\_ Net price \_\_\_\_\_  
 Address \_\_\_\_\_ Carriage \_\_\_\_\_  
 Subtotal \_\_\_\_\_  
 Postcode \_\_\_\_\_ Tel \_\_\_\_\_ VAT 15% \_\_\_\_\_  
 Total payable to DDS £ 57  
 Cheques payable to DDS. Debit my Access/Barclaycard No: \_\_\_\_\_

Signature: \_\_\_\_\_

Circle No. 146



# ORIC ATMOS

Fin Fahey finds out if the Oric Atmos is simply an Oric-1 in a new box, or something more interesting with its new low-cost disc system.

IT IS DIFFICULT to look on the Atmos as a fundamentally new machine since, barring the case design, it isn't. Indeed in many ways the Atmos looks like the machine that Oric was trying to produce in the first place. Unfortunately the need to get to market led to the much-maligned Oric-1 — not a bad machine for the price, but with a number of obvious bugs in the Basic and a very tacky keyboard. Atmos looks like a fresh start, admittedly in a now more competitive marketplace.

The first thing that strikes you about the Atmos is the tasteful casing. It is about time that home micros stopped looking like refugees from an accounts department, and the Atmos looks very elegant in two-tone red and black. It is a useful colour scheme too: the alphanumeric keys are black, and all the others red.

Of more importance is the new keyboard. The Oric-1 nearly achieved the impossible and came equipped with an atrocity one grade worse than a Spectrum, although it did have a space bar. One of the biggest complaints from users was the way the keys started to stick after only limited use.

Now all is changed. The Atmos has an excellent typewriter-style keyboard. The keys show a reasonable degree of travel and feel is excellent. After prolonged use there is no suggestion of key-bounce, and I have not seen as good a keyboard on any micro in this price range.

The layout of the keys is basically the same as on the Oric-1, except that the cursor keys are slightly displaced, which leads to some games programs being a little confusing to play because the Left and

Right movement keys are sometimes reversed.

One oddity stands out; Oric has provided a key on the lower right labelled **Funct**. Perusal of the manual reveals no way of using this key, or what it is intended for. I suspect that it was intended as a Shift key for single-key entry of Basic keywords as on the Spectrum.

## Usual ports

The back panel of the Atmos does not differ from the Oric-1 and contains TV, video and cassette sockets, I/O ports for the disc drives and printer plus the unswitched power input.

The similarities between the Oric-1 and the Atmos are obvious when you remove the case. The only visible difference on the main board is in the ROMs since there is one now instead of two. Oric is offering a £60 upgrade for Oric-1 owners, for which you are paying for a keyboard and a new ROM — still, it is a very good keyboard.

The machine is based on the perennial

6502 CPU, and also comes equipped with the oft-used AY-3-8192 three-channel sound generator chip. Graphics are handled by an Oric-designed ULA chip. There is a total of 64K of on-board RAM, of which 16K is occupied by the boot-in ROM routines.

Text mode on the Atmos is 40 columns by 27 lines, which is just about adequate for simple word-processing applications. A low-resolution graphics mode is available which is equivalent to Teletext graphics and has an 80 by 81 resolution. The highest-resolution mode gives a resolution of 240 by 200.

It is in the realm of Basic that the really vital changes have been made. The first difference that hits you is that whereas the Oric-1 announces some 47,870 bytes of free memory on boot-up, the Atmos gives the lower figure of 37,631. Apparently this is due to a different method of calculating the free memory; there is just as much RAM there. It never struck me as very sensible to count the Hires screen as free.

The Oric-1 bugs seem to be adequately

## Benchmarks

The table shows the time in seconds to run eight standard Basic routines. Our Benchmark routines test out various typical tasks, each repeating an appropriate set of Basic statements 1,000 times.

	BM1	BM2	BM3	BM4	BM5	BM6	BM7	BM8	Av.
Oric Atmos — 6502	1.9	15.5	25.6	27.7	33.5	46.4	69.2	140	44.9
Spectrum — Z-80A	4.8	8.7	21.1	20.4	24.0	55.3	80.7	253	58.5
Spectravideo SV-328 — Z-80A	2.2	5.8	18.2	20.1	20.9	32.8	45.2	236	45.7
BBC Model B — 6502	1.0	3.1	8.3	8.7	9.2	13.9	21.9	52	14.8



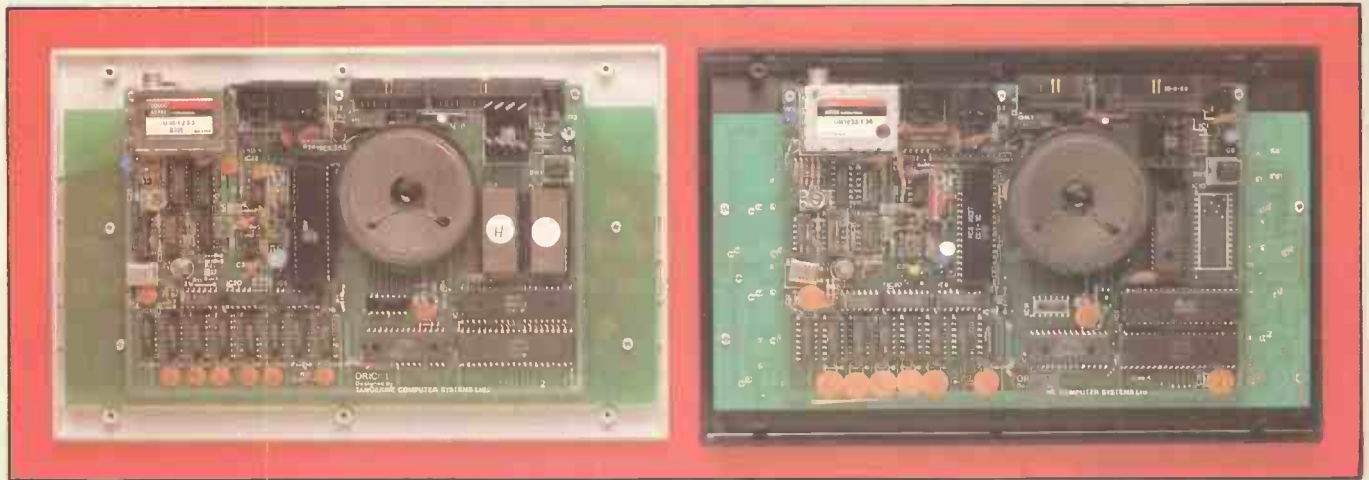

The similarity between the Oric-1 (left) and the Atmos is obvious when you remove the case.

corrected, which is just as well since there were plenty of them. The Tab function now works after a fashion, though it overwrites anything on the line following it. More annoying was the duff Str\$ command, which had a habit of putting spurious characters into the first character position, but it seems fine now. Also rectified is the Oric printer; when it first came out, users found that the keyboard strobe had to be turned off to get an ungarbled listing.

In addition Oric has added some functions to the Basic. The biggest drawback on the Oric-1 is the lack of any proper screen-formatting commands. You can use the Plot command to put a string anywhere on the screen, but it will not move the text cursor, which is a problem if you want to do an Input just afterwards. Some nifty Pokes can do the trick, but there is a better method on the Atmos in the form of a Print@ command, which allows proper formatting.

Perhaps a more major disadvantage is the Oric-1's lack of I/O commands. There is no way provided to store/recall Basic arrays on tape. The Atmos has two commands added, Store and

Recall, to cover this embarrassing gap.

Some of the awkward aspects of Oric Basic remain on the Atmos. In particular, the high-resolution graphics have caused a lot of confusion with users as they rely on a rather obscure serial attribute system for setting screen background and foreground colours. Overall, it looks as though all the real problems have been taken care of. With a decent working Basic, Atmos looks quite plausible.

## Better manual

The final major change lies in the manual. The Oric-1 manual succeeded in patronising the experienced user and baffling the tyro at the same time. However, the Atmos manual is very different. It is 294 pages in length, with a multitude of appendices, which go into some detail about hardware interfacing and the contents of the ROM.

It is a refreshing change to be given this sort of information by the manufacturer and not have to delve around with a disassembler. However, the first-time user might have a hard time with the manual. It

is not a Basic primer, and you may have to look elsewhere for that. Also it is clear that Oric did not run some of the simple programs given at the start of the book because many of them have obvious syntax errors.

There have been some worries that Oric-1 software will not load on the Atmos. This may be for two reasons. First, some software may use Oric ROM routines which have been relocated. Not much can be done about this, so check carefully for Atmos compatibility before buying.

Secondly, the Atmos cassette operating system is tetchy at times. It tends to throw spurious Errors Found messages when loading, which can sometimes mean that the program does not load. A correction program is provided in the manual, or the slow version of a program can be loaded — if you happen to have the time.

It is a bonus for the Atmos that it has a compatible software base, but barring Tansoft and a few other software houses' products, the general standard is pretty bad. If the Atmos gains credibility this may change.

*(continued on page 61)*



# Sinclair ZX Microdrives and ZX Interface 1

## The affordable alternative to floppy discs...



## ...in the shops, now!

The unique ZX Microdrive system sets the ZX Spectrum apart from all other computer systems.

At a fraction of the cost of floppy discs, it gives fast access to 85K of program and data on Microdrive cartridges. And it opens up exciting possibilities through an RS232 interface and local area network.

**ZX Microdrives – the fast way to save or load 85K of program and data. £49.95**

ZX Microdrives are controlled by ZX Interface 1.

For their compact size, they're massively powerful. Each interchangeable Microdrive cartridge stores at least 85K of program and data!

You can create up to 50 files on the cartridge – identified by titles of your own choice.

And when you want to display the data again, Microdrives give you lightning-fast access:

- Just 3.5 seconds to access a typical file.
- Only 9 seconds to LOAD a typical 48K program.

ZX Microdrives use the Spectrum's own power supply.

Your first Microdrive is connected to Interface 1 by a Microdrive lead. Then, up to 7 more Microdrives can be added using Microdrive connectors. That gives you a minimum of 680K bytes of on-line capacity.

With memory like that, the possibilities are limitless – stock control, word-processing, even huge adventure games!

With each Microdrive, you'll receive a Microdrive connector and Microdrive demonstration

cartridge. Blank Microdrive cartridges cost £4.95 each. They are available in packs of 4 (with a free cartridge wallet) or singly.

**ZX Interface 1 – the multi-purpose controller. £49.95**

ZX Interface 1 is a multi-purpose device. It controls up to 8 Microdrives. And it adds file-handling and communication facilities to your Spectrum.

So in one low-priced unit, you also get these two built-in features:

- **RS232 interface** This industry standard interface allows you to link your Spectrum with full-size printers, communicate with other computers employing RS232, and transmit data over telephone lines via modems.
- **The ZX Net** Now you and your friends can transfer programs and data on a local area network – or even play computer games together.

The ZX Net makes it easy, and fast!  
It links between 2 and 64 Spectrums, transmitting at 10,000 characters per second. (So a full screen is transferred in around 3 seconds!) With the ZX Net, only one person need type in a program. And a Microdrive or printer can be shared by everyone in the network!

ZX Interface 1 offers you all these facilities, and retains the same peripheral port as the Spectrum itself.

With each ZX Interface 1, you'll receive a connecting lead for the first Microdrive; a ZX Net

lead with jack plugs; plus a comprehensive manual. An RS232 lead is available as an optional extra at £14.95.

Available from: larger branches of Boots • WHSmith Computer Stockists • Greens Computer Centres • Spectrum Computer Stores • and larger branches of John Menzies • Dixons • Laskys • Currys • John Lewis Partnership • Rumbelows • British Home Stores • House of Fraser and many other good computer stockists nationwide.

**Find out more – in your local shop!**

The best way to evaluate ZX Microdrives and Interface 1 is to see them for yourself.

There is a full range of ZX peripherals – including ZX Interface 2 for joystick and ROM Cartridge capability, alongside the only computer that supports them – the ZX Spectrum!

For more information, telephone Sinclair Research Ltd, on 0276 685311.

© Sinclair, ZX, ZX Spectrum, ZX Microdrive, ZX Net and ZX Interface are trade marks of Sinclair Research Ltd.

**sinclair**

• Circle No. 147

(continued from page 59)

The Atmos has one other card to play, in that the disc drives are now available. Oric established its commitment to cheap and cheerful peripherals last year with the release of the MCP-40 printer/plotter. This is still available at a £40 discount for new Atmos owners.

Oric has plumped for Hitachi 3in. single-sided drives as the basis of its Microdisc system. They offer 160K of immediately on-line storage. However, Hitachi discs are double-sided, and each can be turned over to give a second 160K, which has led to the misleading impression that the drives will offer the full 320K. Oric is hoping to offer double-sided drives shortly, which will use all the disc space available.

## Coffin-shaped

The Oric Microdisc is an elongated coffin-shaped box. A slot for the disc occupies one of the small sides, while at the other end are the sockets for power and connection to the Atmos. The unit is finished in the same smart red and black as the Atmos itself. An extended power-supply unit is supplied with the first disc drive. This can power two drives and the Atmos.

The 3in. discs are neat slim wafers about 5mm. thick, and are not in the least floppy. They look far more durable than the average 5.25in. discs, an impression reinforced by the presence of steel shutters which cover the access slots when the disc is not in use. The casing has built-in plastic write-protect tabs too, which can be flipped on or off using the tip of a pencil.

Oric has provided a fairly simple DOS orientated at the home user, who will probably not have encountered such a thing before. The same types of files are supported as might be stored on cassette, namely Basic programs, straight RAM dumps, and real, integer and string Basic arrays.

## CP/M standards

The disc commands used to manipulate the files are of a very similar format to the equivalent cassette commands. File names follow similar standards to CP/M. For example, a six-character file name followed by a three-character extension, with the two separated by a full stop.

In addition to the cassette-compatible commands, Oric has provided a single-field file-access system. Thus for a given opened file, data can be read or written one field at a time using !Get or !Put. All disc commands are preceded by a !, which is the standard method of adding commands to Oric Basic. Unfortunately, only one file can actually be open for I/O at any given time.

In addition to the file-access commands, there is the clutch of regular commands you would expect to see in any DOS. Thus !Dir gives you a disc catalogue, !Del deletes a named file, !Copy copies a file, and !Backup is used to copy a whole disc.

Of prime interest to new disc users will be the !Help command. It can summon one of a number of text files on the system disc to explain any given command. Naturally the files could be replaced with those of the user's choice.

Oric has added a couple of wrinkles you would expect to see on more expensive systems. First, the system supports wildcard file names, including use of both the \* and ? characters. This means that asking to delete file \*.Com, for example is to ask to delete all files with an extension Com.

Secondly, the system supports command files. Any file ending in .Com is taken to be a command file, which means that the file can be loaded simply by entering the file name preceded by a !.

If the file is Basic or machine code and set to auto-run, then you have simply added a new command to Basic. On one of the discs I was issued there was a Basic version of the CP/M Type command in the form of just such a file — there is no built-in Type function.

## Specification

**CPU:** eight-bit 6502A

**RAM:** two models, 16K or 48K; max. RAM 48K

**ROM:** 16K containing Basic and operating system

**Keyboard:** 57 full-travel keys with standard QWERTY layout and spacing

**Display:** outputs to separate domestic TV or RGB monitor; displays 27 lines of 40 characters, 80- by 81-dot teletext-style low-resolution graphics or 200-by 240-dot high-resolution graphics; eight colours available in all display modes, character set is user definable

**Sound:** AY-3-8912 sound chip provides three-channel sound across seven-octave range, allowing three-note chords and white noise; outputs through Atmos's built-in loudspeaker, or can be connected to external hi-fi via cassette port

**Interfaces:** two-speed cassette I/O, Centronics-style parallel printer interface, expansion port for Oric Microdisc drives or other hardware add-ons

**Size:** 280mm. (10.75in.) by 175mm. (7in.) by 52mm. (2.5in.); weight 1.1kg. (about 2lb.)

**Options:** up to four single-sided 3in. Oric Microdisc drives, providing 160K per side; Oric MCP-40 four-colour printer/plotter

**Manufacturer:** Oric Products International; made in England

**U.K. prices:** £175 including VAT for Atmos 48K model; Oric MCP-40 printer/plotter £165 including VAT, with £40 discount when Atmos purchased too; Oric 3in. Microdisc drive £220; available now through High Street retailers

**U.K. distributor:** Oric Products International, Cambridge Techno Park, 645 Newmarket Road, Cambridge CB5 8PB. Telephone: Teversham (02205) 5141

Sad to say the system does not feature anything beyond sequential file types. If you want random-access files, you can either rewrite the DOS, or go for a slow system of assigning a new file name to each record. The latter solution is at least possible, because there is no limit, apart from overall capacity, on the number of files a disc can hold. But it is not a system for large, fast-access databases.

In action, the drives are fast and will seem miraculous to anyone converting from cassettes. A high-resolution screen, about 8,000 bytes of data, loads from disc in about two seconds.

So what will the user be doing with Microdisc? Word processing is one possibility. I was given a preview disc of Tansoft software, including the Author word-processing package. It had just been converted for use with the DOS and clearly was not entirely ready. However, Author combined with discs makes a reasonably capable and cheap word-processing system. Also present were a spreadsheet, Oric-Calc, which looks simple but capable, and Oric-Mon, a very plain machine-code monitor. An obvious gap is a decent disc-based assembler, since there is not even an adequate cassette-based one available.

The price of the Microdisc system will probably be £220 for one 160K drive, which seems reasonable enough until you consider the cost of blank discs. At the moment they are priced at around £5 each, which is pretty discouraging to the end-user.

## Conclusions

- With its excellent keyboard, the Oric Atmos is something better than just a corrected Oric-1. It is being pushed as an Electron-killer, and Oric may well have some success here since Atmos has the larger memory.

- The ROM errors which plagued the old Oric-1 have indeed been corrected, and new Basic functions added to cover embarrassing gaps. Oric-1 users may feel jaundiced at not getting a free upgrade, but this is partly offset by the new keyboard they will get for their £60.

- The horrible Oric-1 manual has been entirely replaced. The new manual may not entirely please the first-time machine buyer.

- The Atmos Microdisc is a powerful system for its price. The drives and discs themselves seem reliable and durable, although more prolonged use should test this.

- The Atmos DOS is designed with simplicity in mind, and should prove easy to use for those unfamiliar with disc systems. Its biggest drawback is the lack of any easy method of random file access.

- Apart from its superiority in small-scale software development, the Atmos makes a surprisingly good word-processing system, particularly with discs, and may prove worthwhile in other small business applications.

# Revaluation

Now the Atmos, the Amstrad and the Einstein have been announced, which small micro offers the best value on the market? Jack Schofield finds out.

THERE IS little argument about the requirements of a really good home micro. They are: a good keyboard, lots of memory, good sound and graphics facilities, a powerful Basic, a range of ports for cheap peripherals, a wide range of good, cheap software, and the price should be under £200.

Stated so baldly it is clear why the Commodore 64 has been such a success, in that it fulfils most of the requirements. However, the 64 has some obvious flaws. For example, the Basic and operating system are very poor, while the cartridge slot is a joke, and such deficiencies tempt other companies into the field.

The three most recent challengers are the Oric Atmos, the Tatung Einstein and the Amstrad CPC-464. What they all have in common is that they use new 3in. microfloppy discs as standard. This separates them from the Sinclair machines, with their Microdrive fast tape systems, and the old faithfuls such as the Atari and Commodore micros which use 5.25in. discs.

This is unfortunate in many respects. The 3in. disc drive is physically bigger than the 3.5in. Sony type, yet it can hold only half as much data because the 3in. disc has only half the usable area of the 3.5in. size. The 3.5in. disc is in use by Apple, Hewlett-Packard and many others, so it is already becoming the industry standard. Also, the 3.5in. size is recommended by the CCTA government purchasing committee.

The 3in. size is backed mainly by Hitachi and Matsushita, and almost no one outside Japan. Therefore it is an uncertain proposition, and anyone who buys 3in. discs should be aware that they are unlikely to have much of a long-term future.

However, given that the disc drives are cheap, how do the actual machines compare?

## ATMOS

The Oric Atmos, reviewed in this issue, has good sound and adequate graphics. The serial attribute system it uses is the same as that used in Prestel, Ceefax and Oracle, and rather limited, though it is economical in memory terms. The Atmos lacks a proper cartridge slot, though it has an expansion bus which can be used instead. Also it lacks joystick ports.

The disc system does not offer true random access, and this is a major limitation since it is more of a fast tape system. Finally, because it uses the 6502 chip, there is no obvious upgrade to CP/M.

The advantages of the Atmos are the reasonable Microsoft-type Basic and the built-in Centronics printer port. Also, there is a small range of software available, thanks to the success of the Oric-1.

## EINSTEIN

The Tatung Einstein is a Z-80A micro with 64K of RAM plus 16K of video RAM. There is 8K of ROM, which does not include the Basic. The Basic and disc operating system supplied are Xtal-DOS and Xtal Basic 4 from Crystal Research. They are highly regarded, and have been sold for Sharp micros — see *Practical Computing's* April 1980 and April 1983 issues. Xtal-DOS runs CP/M software.

Graphics are about average, with a maximum resolution of 256 by 192 pixels or

40 characters by 24 lines of text. There are 16 colours and 32 sprites available. Sound consists of three voices. The Einstein uses the same popular AY-3-8910 chip as the Oric-1 and Atmos, among others.

The Einstein scores in the provision of ports. These include an eight-bit user port, a bus expansion labelled Tatung pipe, a port for disc drives, two DIN female analogue-to-digital ports suitable for attaching joysticks, a Centronics printer port, and an RS-232C port.

In addition there is a built-in 3in. Teac disc drive. From the media point of view this is a new format for CP/M, but Tatung claims it is easy to port programs across, and no doubt it will be assisting in this.

Unlike the Oric and Amstrad micros, the Einstein is being manufactured in the U.K. Unlike Oric and Amstrad, Tatung is a very large multi-national corporation, with factories in Taiwan and Japan, amongst other locations.

The Einstein is much more like a proper business machine than either the Atmos or the Amstrad. Its main strength is its copious supply of input/output ports. However, being new, it suffers from an acute shortage of games software. Worse, its CP/M capability is limited by the 40-column screen, though it is claimed an 80-column option will be available later. Finally, it is relatively expensive at £499 including VAT.

## AMSTRAD

The Korean-made Amstrad CPC-464, due to be launched this summer, is by no means revolutionary as a micro. The main features are a Z-80A CPU, 32K of ROM

	CPU		Memory			Screen display			
	Speed (MHz.)		RAM	User RAM	ROM	Colours	Sprites	Resolution (max.)	Text (max.)
Acorn BBC B	6502	2	32	27.5	32	8	no	640 × 256	80 × 32
Acorn Electron	6502	2	32	20.5	32	8	no	640 × 256	80 × 32
Amstrad CPC-464	Z-80	4	64	43	32	27	yes	640 × 200	80 × 25
Atari 600XL	6502	1.8	16	13.5	24	256	yes	320 × 192	40 × 24
Atari 800XL	6502	1.8	64	37.5	24	256	yes	320 × 192	40 × 24
Commodore 64	6510	1	64	38	20	16	yes	320 × 200	40 × 25
Dragon 32	6809	1	32	24.3	16	8	no	256 × 192	32 × 16
Enterprise	Z-80A	4	64	58	32	256		672 × 512	84 × 56
Lynx	Z-80A	4	48	13.7	16	8	no	256 × 248	40 × 24
Memotech MTX-500	Z-80A	4	32	31.5	24	16	yes	256 × 192	40 × 24
Oric Atmos	6502	1	48	36.7	16	8	no	240 × 200	40 × 27
Sinclair Spectrum	Z-80	3.5	48	40	16	8	no	256 × 192	32 × 24
Tatung Einstein	Z-80A	4	80	42.3	8	16	yes	256 × 192	40 × 24

and 64K of RAM, but more important is its very low price. The Amstrad also comes with a built-in cassette recorder plus a separate monitor. It is a package, like the early Pet and Sharp micros. Or rather it is four packages, all based on the same machine.

The cheapest system comprises the CPC-464 with cassette recorder and black-and-white monitor for £229. With a colour monitor the price is £329. With a monochrome monitor and 3in. Hitachi disc drive, the price is £429. Finally, with the colour monitor instead, the price is £529. Along with the disc drive you also get CP/M and DR Logo. So in effect Amstrad is offering a 64K colour/sound computer with a real keyboard for not much over £100.

The CPC-464 itself seems well made, and has a number of extra features over the other machines in its class. These include three-voice stereo sound, a separate numeric keypad, a cross-shaped set of cursor-control keys, and an 80-column text capability which makes sense of CP/M. More legible 20-column and 40-column character sets are also provided.

Another new feature is that the colour signal can have three intensities, which is claimed to be a first for a digital system. This provides 27 colours, though only 16 can be displayed at once.

The CPC-464 has an acceptable number of ports. It has a disc interface, a printer interface, and a user/joystick port. The printer and disc ports are actually only edge connectors, but this is a low-cost machine.

The Basic supplied has been written by Locomotive Software, and is like Microsoft Basic in style, with extensions for features such as windows and sound envelopes. Subjectively it seems fast and well implemented; it does not crash and there are no obvious bugs, but a final conclusion must await more extensive testing.

When it comes to software, the CPC-464 looks like being well supported, as Amstrad has been quick to get early models into the software houses. Over a dozen games were implemented before the trade launch, plus Hi-Soft Pascal, moved over from the



The £229 Amstrad CPC-464 system comes with built-in cassette recorder.

Sinclair Spectrum. Amstrad claims more than 50 packages will be ready when the machine reaches the shops.

In addition, there could eventually be good availability of CP/M software on disc if Amsoft dedicates itself to porting programs across. However, there will have to be some consideration of prices. Few buyers of a £429 system will want to spend £295 on, say, WordStar.

It is always a risk buying a new machine, and the CPC-464 has not even reached the shops yet. However, it looks like presenting a formidable challenge to the other micros on the market.

## The rivals

The main competitors for the three new machines are the Acorn BBC Model B and Electron, the Atari 600XL and 800XL, the Commodore 64 and the Lynx. The Spectrum is not in contention, as it is still much the cheapest way into real computing, and has lots of cheap games available.

Of the rest the Lynx looks to have the least chance, as it is virtually twice the price of a comparable Amstrad outfit. As the Lynx has not built a large following or a strong software base, it will have trouble defending its market position, but we will shortly be reviewing the Laureate system to see just what it offers.

The Atari micros are well made and have lots of good software, but they look expensive compared to the Oric and Amstrad micros. Superior quality should

enable them to see off the Atmos, but the Amstrad's easy access to CP/M represents a real threat — if Amstrad can deliver.

A major source of complaint among Atari owners is the high price of software, so the recent price cuts should help. Certainly there is more chance of Atari software getting cheaper than the quality of Oric hardware suddenly improving.

The BBC Model B is still in a different class to the three new machines, and will presumably continue to sell at a premium price. By now it has enough software support and enough readily-available peripherals — including the Z-80 and 6502 second-processor options — to tackle a wider range of tasks than them, and in many cases this will make it worth the extra cost.

However, the Electron is a different matter. While it is a fine machine for learning to program the Basic, it is starved of RAM, woefully underspecified, and ridiculously overpriced. The Electron is meant to ride on the coat-tails of the BBC Model B, but its lack of joystick ports, a printer port, a cartridge slot, sideways ROMs, full BBC sound facilities and mode 7 graphics will surely find it out eventually. Both the Oric Atmos and Amstrad CPC-464 are sufficiently more powerful, and more versatile, to do it a great deal of damage.

The Commodore 64 remains an enigma. The Oric Atmos is not sufficiently cheap, compared to discounted 64s, to be a threat. However, the Amstrad is a better machine than the 64 in virtually every department: better Basic, better colour, better made and very much cheaper. The recommended retail price of the Commodore 64 is the same as the recommended price of the cheapest Amstrad outfit, so effectively the Amstrad offers a free cassette recorder and a free monitor.

Also, unlike the Apple, Atari and BBC Model B, the Commodore 64 has not built up a large software base of good games to sustain it into the future. This makes it particularly vulnerable.

However, Commodore is not likely to sit idly by while its best selling machine is done to death in the marketplace. Either the 64 could have its price dramatically reduced, or be replaced by the non-compatible models 264 and 364 already unveiled.

Whether the Enterprise, formerly the Elan Enterprise, appears or not, the market will surely undergo some profound changes before the winners are decided.

Sound	Storage		Price	Comments	
	Voices	Cassette			Disc
	4	any	needs DFS	£399	Needs additional chip for discs
	1	any	no	£199	Beware cost of add-ons
	3	built-in	3in.	£229	Includes tape and monitor
	4	special	special	£160	Needs dedicated tape recorder
	4	special	special	£250	Needs dedicated tape recorder
	3	special	special	£229	Needs dedicated tape recorder
	1	any	5.25in.	£175	No lower-case letters
	4	any	TBA	(£200)	Does not exist
	1	any	5.25in.	£225	
	3	any	upgrade	£275	Has 16K separate video RAM
	3	any	3in.	£170	Actually has 64K of RAM chips
	1	any	no	£130	Beware cost of add-ons
	3	no	built-in	£499	Includes built-in 3in. disc

# EPSON PX-8

After a bare two years of existence the mains-powered transportable is becoming obsolete. Ian Stobie reports on one of the new true portables about to take its place.

ONE LOOK at the Epson PX-8 makes the days of the bulky mains-powered transportable seem numbered. It weighs not a barely luggable 30lb. but under 4lb., and it is powered by rechargeable batteries. On the desk top the PX-8 takes up no more space than an A4 pad, yet inside is a Z-80 like processor running at 3.8MHz and a standard 64K of RAM expandable to 184K. WordStar and other CP/M software is included in the £798 price.

## Closing the gap

Mains-powered machines still offer some advantages, generally having larger displays and built-in disc drives, but the PX-8 illustrates how the gap is narrowing. Its liquid crystal display panel shows eight lines of text across a full 80 columns; it has battery-backed RAM as well as a built-in microcassette drive for storing programs and data.

Most important of all, the PX-8 has CP/M 2.2 in ROM. Epson has set it up so that both microcassettes and battery-backed RAM are as easy to use as floppy-disc drives.

The PX-8 looks like an unassuming transistor radio when packed up for carrying. The keyboard is concealed behind a grey cover, and the display panel is folded down flat over the microcassette drive. A carrying handle completes the anonymous, tranny-like effect. Only the blank, predominantly ivory-coloured plastic casing is presented to the world. This restraint is probably wise, as a portable computer is quite a concentrated and stealable form of wealth.

## Special keys

Pulling off the cover reveals the full-size dark grey keyboard. The standard QWERTY layout is completed by a sensibly laid out cursor-control pad, four programmable function keys and a number of special keys. The keyboard has a good touch-typing feel, the keys having a short, positive travel. Two feet under the back of the machine fold down to tilt the whole unit, presenting the keyboard at the angle many people like when typing.

A catch to the right of the keyboard unlocks the display panel, which can then be folded up through a number of click positions ranging from 90 degrees upright to 180 degrees flat in relation to the keyboard. This point is quite important, as reflections from the glass above the liquid crystal display elements can confuse the

image on some portable computers with non-adjustable displays.

The PX-8 display panel shows 480- by 64-dot graphics or eight lines of text across 80 columns on a display area measuring 8.75in. by 1.5in. This is quite a large display by the standards of current LCD technology. We have criticised the large displays on some machines — for instance, the Sharp PC-5000 — for poor legibility. The Epson is not too bad in normal light even indoors, but in a dark corner it does become difficult to read. A slide control below the display helps, allowing you to adjust the viewing angle to get the best contrast.

Another weakness of some large liquid crystal display panels is the appreciable time they take to update. They can be noticeably sluggish, particularly at low temperatures. In practice at normal office temperatures I found the PX-8 display response quite acceptable.

On the underside of the PX-8 is a 3in. square panel which pulls off to reveal two sockets for the ROM capsules that are supplied with the system. Each capsule can contain up to 32K. The capsules themselves consist of just a 32K ROM chip mounted in a plastic carrier. They push in with the fingers and can be levered out again with a pen. It is a very simple and effective system.

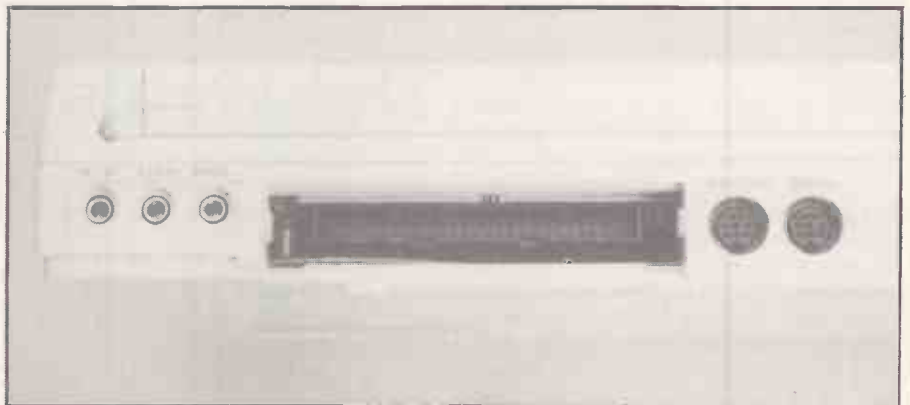

Interfaces include analogue input, bar-code reader port, and expansion bus.



The PX-8's rechargeable cells are built in.

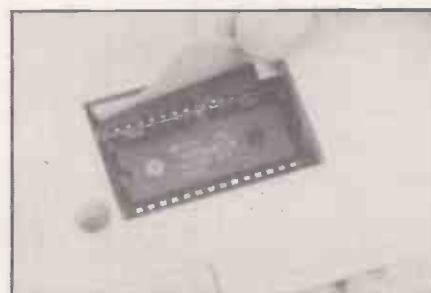

The 32K system ROM, containing genuine CP/M2.2 from Digital Research.

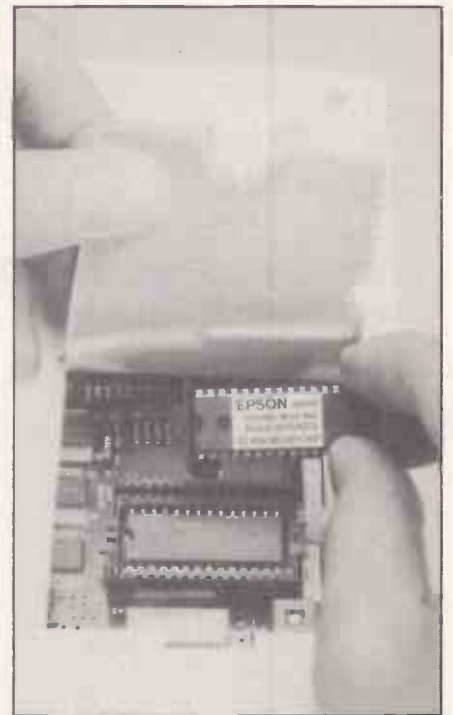

Changing ROM capsules is easy. They are treated as read only discs by CP/M.



When you turn on the PX-8 it issues a beep through the speaker mounted just above the keyboard. It then displays a menu that is a simple Epson addition to CP/M. Otherwise, what you have is standard CP/M 2.2, contained somewhere inside the machine on another large ROM chip.

The menu simply shows any .Com files that are contained on either of the two capsules mounted in the ROM sockets, and lets you run them by moving the cursor over them and hitting Return. If you prefer, hitting Escape will give you the normal sparse CP/M prompt, A>.

PX-8 CP/M is set up to recognise the two ROM sockets under the machine as drives B and C. Drive A is part of the internal RAM, initially set at 9K, which acts as a silicon disc. Data remains in RAM when you turn off the machine's main switch as the PX-8 does not, in fact, let you turn off RAM.

## Extra capsule

The review system came with ROM capsules containing WordStar, a portable Micropro spreadsheet and schedule program, Basic and a set of CP/M utilities. PX-8 owners will also get a fifth capsule, containing a version of the Cardbox Plus database program, though it was not ready when we got our system.

To run one of these programs all that is necessary is to make sure the correct capsule is plugged into the machine. You can then select it either from the main menu or by typing the file name in the normal CP/M way, for instance

B:WS

for WordStar. Changing capsules with the machine on seemed to do no harm.

The utility ROM contains the usual  
(continued on page 67)

## Benchmarks

The table shows the time in seconds to run eight standard Basic routines. Our Benchmark routines test out various typical tasks, each repeating an appropriate set of Basic statements 1,000 times. The Basic used in Epson Basic version 1.0, as supplied on ROM capsule with the PX-8.

	BM1	BM2	BM3	BM4	BM5	BM6	BM7	BM8	Av.
Kaypro 10 — Z-80A	1.2	3.8	9.5	9.7	10.5	19.0	29.5	51	16.9
Epson PX-8 — CMOS Z-80 clone	3.5	7.1	18.3	18.0	20.7	39.0	61	88	32.0
Epson HX-20 — CMOS 6301	2.6	15.2	33.4	33.2	35.2	60	101	132	51.5
Tandy 100 — CMOS 80C85	4.8	10.1	26.7	29.7	31.4	47.5	64	323	67.1



Above: The built-in microcassette drive can hold about 32K on each side of a cassette.

Below: The compact PX-8 runs CP/M software and offers WordStar on a ROM.



# One name stands out for quality and value



When you choose a TAXAN monitor from Kaga, whether it's monochrome or RGB colour, you're choosing the best.

## COMPATIBILITY

TAXAN monitors are compatible with all popular micro computers. Apple™, Acorn/BBC™, IBM™, Commodore™, Oric™, Dragon™, Research Machines™, Osborne™, Tandy™, Sinclair™ (with interface) – you name it, KAGA TAXAN's made for it.

## COLOUR RANGE

There are several TAXAN Colour Monitors available from around £200 to £399, including:-

**VISION EX** (Resolution: 380 dots) – PAL or RGB input – Built-in Speaker – Equipped with smoked filter – Ideal display for Computers and/or Video Recorders.

**VISION II** (Resolution: 510 dots) – RGB Colour Display – Capable of 80 column display – Equipped with smoked filter – Built-in switchable interface.

Available from your local computer dealer; selected branches of W.H. Smith, Lasky's, Curry's and other leading retailers. EXCLUSIVE UK DISTRIBUTOR.

**VISION III** (Resolution: 640 dots) – RGB Colour Display – Suitable for 80 column display – Utilises latest matt black non-glare tube – Built-in switchable interface.

**VISION PC** – IBM compatible version of the Vision III in 'IBM style' casing.

## MONOCHROME RANGE

**NEW: THE KX SERIES** of monochrome monitors from around £100 – 12" non-glare flat screen – Green or Amber display – More than 20 MHz – Built-in handle – Optional 'tilt and swivel' stand – IBM PC™ compatible versions available.

## RELIABILITY

TAXAN monitors are among the most reliable displays around, and are backed by a full 12 months' warranty.

**TAXAN IS THE NEW BRAND NAME FOR PRODUCTS MANUFACTURED BY KAGA ELECTRONICS CO. LTD.**

All prices ex-VAT and correct at time of going to press.

## NLQ DOT MATRIX PRINTERS



**TAXAN**  
**KP810** (£299)  
 (80 col. model)  
**KP910** (£399)  
 (156 col. model)  
 - 140 cps and near-letter quality (NLQ) print  
 - Supported by all popular software.  
 - High resolution graphics

**RING 0442 60155 FOR DETAILS**

TRADE AND OEM ENQUIRIES WELCOME.



Data Efficiency Ltd

**Whatever your system... insist on KAGA TAXAN**

# EPSON PX-8

(continued from page 65)

CP/M utilities like Pip, Stat, Submit and two communications utilities, Filink and Term. The configuration utility Config lets you change the size of the silicon disc, drive A. On the standard machine, with 64K of RAM, you can increase drive A to 24K.

The figure of 24K sounds a lot, but it soon gets used up when you run WordStar. A 2,000-word document, about the length of this article, mops up most of it, as WordStar automatically creates a backup file when you edit, effectively halving your available RAM. This makes the optional 128K RAM pack an attractive option.

The RAM pack is a wedge-shaped unit which clips neatly under the PX-8, giving the keyboard the same slope as the fold-down feet. It has its own separate battery backup, and plugs into the serial port on the back of the machine. When the RAM pack is present the system regards it as disc A, and 120K of the 128K is available to the user.

It is not possible to add this 120K to the 24K available inside the machine for an even bigger silicon disc. Instead this internal RAM is relinquished to the system, giving you a bigger area for CP/M to put programs in. We did not have a RAM pack to review but it probably makes the system much more usable. The combined price for the PX-8 and the RAM pack when bought together still comes out below £1,000.

## CP/M commands

The standard PX-8 also comes with a microcassette drive, located above the keyboard. It takes standard C-30 microcassettes as used in dictation machines, which typically can hold somewhere between 24K and 32K of programs or data per side. CP/M regards the microcassette as drive H. This is very useful, as the user does not have to worry about where a file is located on the tape, and can use standard CP/M commands like Dir and Pip with it.

There are still some things you cannot do. Epson has implemented CP/M so that a file directory is put on the tape, but the cassette is still organised sequentially; random-access files are not supported. And tape is still a fundamentally slow medium. This rules out editing a tape file directly from WordStar, for example. But you can copy a document edited from the RAM drive A to tape later, using either Pip or the WordStar Copy command. This allows you to back up important files, or to make copies for distribution on the easily mailed microcassettes.

The microcassette can also be used to

play audio tapes through the PX-8's speaker, or through headphones connected to the earphone socket on the back of the machine. This could allow you to use the system for audio typing, but unfortunately it will not work with WordStar. WordStar has its own ideas of what the tape is for, and turns off the cassette if you try to

## Specification

**CPU:** eight-bit Toshiba CMOS processor, code-compatible with the Z-80, running at 2.5MHz.

**Memory:** 64K RAM; 32K ROM containing the operating system

**Memory expansion:** two sockets for 32K ROM capsules; optional 128K clip-on silicon-disc unit

**Display:** fold-away flat liquid crystal display panel measuring 222mm. (8.75in.) by 38mm. (1.5in.) showing eight lines of 80 characters text and 480- by 64-dot graphics

**Keyboard:** full-size QWERTY layout keyboard with 72 keys

**Mass storage:** built-in microcassette drive, capacity 32K per side on standard C-30 microcassettes; supports sequential access controlled automatically from CP/M

**Interfaces:** bar-code reader port, RS-232C, high-speed serial, two-channel analogue input, speaker output, system expansion bus

**Portability:** the PX-8 weighs 1.75kg. (4lb.) and is battery powered with both primary and backup nickel-cadmium cells; mains adaptor/charger supplied with the system; desk footprint is very nearly A4 — 297mm. (11.5in.) by 216mm. (8.5in.) — and the case is 46mm. (1.75in.) high

**Software in price:** CP/M 2.2 on built-in ROM, and CP/M utilities; a PX-8 adapted Basic from Microsoft, Caxton's Cardbox Plus, and Micropro's WordStar, Calc and Scheduler on plug-in ROM capsule

**U.K. price:** £798 plus VAT for PX-8 with 64K of RAM, microcassette, and bundled software

**Hardware options:** clip-on 128K RAM pack functioning as silicon disc £270 or £200 extra if bought with PX-8; mains-powered dual 5.25in. floppy drive unit £498; battery-powered 3.5in. 360K microfloppy drive on Sony-style discs announced; battery-powered CX-20/21 acoustic coupler £160; Epson printer range includes two battery-powered models, the £95 40-column P-40 thermal printer available now, and the £160 80-column thermal transfer printer scheduled for October

**Software options:** third-party products already announced for the PX-8 include TCL Pascal, Fortran, C, and a package on ROM capsule called Portascribe for roving sales reps; most CP/M software for the QX-10 is claimed to transfer readily to the disc-based PX-8 system

**Manufacturer:** Epson Corporation, made in Japan

**U.K. distribution:** Epson (U.K.) Ltd, Dorland House, 388 High Road, Wembley, Middlesex HA9 6UH. Telephone: 01-902 8892. Available now

start it running with the function keys.

Epson will be offering two different disc units as options. The mains-powered 5.25in. twin-drive unit is the same as used with Epson's QX-10 desk-top machine, and the company says most QX-10 software will run with little change on the PX-8. We were unable to check this. A battery-powered 3.5in. unit using micro-floppy discs of the Sony type has been announced, but no details are available other than that the drive mechanism is made by Epson itself, not Sony.

The PX-8's Basic is written by Microsoft with some Epson additions. RAM is divided up into five partitions, and you can have a separate program in each. When you invoke Basic it is actually copied across from its ROM capsule into RAM, leaving you just 23.4K on the 64K standard machine to put programs in.

The Basic lacks the sophisticated sound and graphics commands of later Microsoft Basics like IBM Basica, but has other commands that support the specific features of the Epson machine. Individual dots in the LCD panel can be turned on and off, and the microcassette can be used from Basic for either file storage or audio output.

The PX-8 has a built-in real-time clock, and the Alarm and Wake commands let you make good use of it. Alarm causes the speaker to sound at the specified date and time, displaying an optional message. Wake causes a specified CP/M program file to be run at some future time. Wild-card parameters let you specify repeated actions with either command. So for instance

```
ALARM "*"/*/*84", "*"/*:00:00",
"Cuckoo!"
```

will sound the alarm on the hour throughout 1984.

## Conclusions

● CP/M running on a battery-powered A4 machine! The PX-8 delivers the goods in an impressive way: it offers a very good specification and good-quality bundled software at a competitive price.

● The liquid crystal display is easily large enough for convenient use. Its legibility is acceptable in normal office lighting conditions, but in dim surroundings you would have to provide extra illumination. The full-size keyboard is excellent.

● The microcassette works reliably but is slow. In practice most users will use the RAM disc for routine storage of their own files, and so will probably want the extra 128K RAM pack. Together microcassette and RAM disc form a very acceptable and compact alternative to floppy discs.

● The PX-8 has the kind of specification likely to appeal to journalists, so you should probably make some allowances when reading reviews like this one. All the same, by anybody's standards the PX-8 is a well thought-out and impressive system, equal to the task of boldly taking personal computers where they have not been before. □

WEIGHING just 7.5lb., the Apple IIc is a semi-portable version of Apple's best selling but venerable Apple II. In hardware terms it is a completely new machine, but it preserves compatibility with the very large base of software that exists for the Apple II family.

Priced at around £1,065 for a system with one disc drive and a separate 11lb. green screen monitor, the Apple IIc is primarily aimed at the professional and business user. There are several improvements in specification over the existing Apple IIe model. Apple has taken pains to make the IIc easier to set up and use, and is offering an optional mouse to go with the system.

I visited Apple's U.K. headquarters to try out the IIc and find out Apple's plans for it. The machine is being assembled by Apple's plant at Cork in Ireland for shipment into the U.K. Volume supplies are expected from the beginning of June.

## Business sector

Apple intends to continue making the Apple IIe, stressing both its slightly lower basic cost and its greater hardware flexibility. The list price of the IIe has been dropped to £587 for the basic 64K unit, with a dual-drive system plus monitor costing about £1,095. But the IIe is bulky and initially hard to set up. Apple intends the semi-portable IIc to rapidly take the business and professional sector, which is the core of the IIe market.

The Apple IIc is very compact and stylish. It is the first machine Apple has taken to an outside design company, namely Frog Design of West Germany. There is no resemblance to the older Apple IIs. Frog was responsible for styling the Sony Walkman, and has come up with a simple slab-like shape, measuring just under 12 inches square and 2.5in. thick. The IIc has a different colour scheme to other Apples, a very pale near-white with slightly darker keys.

The full-size QWERTY keyboard takes up almost the full width of the machine. It has exactly the same spacing and layout as the Apple IIe keyboard, despite the greater compactness of the machine; in fact the IIc

# APPLE IIc

Ian Stobie takes a first look at the compact version of the evergreen Apple II.

will fit inside the open lid of a IIe. The Reset button has been moved further out of harm's way, and since the keys have been given a shorter travel the keyboard has a faster typing feel.

Keys such as Shift, Return and Caps Lock have these words engraved on them rather than obscure international symbols. The U.K. IIc machines have a £ sign on the Shifted 3 key, with a switch next to the Reset button to let you toggle between the £ and # signs. A second switch mounted above the main keyboard lets you switch between 80- and 40-column display.

Built into the right-hand side of the machine is a half-height 5.25in. floppy-disc drive, which has a formatted capacity of 143K. It will read discs produced on the Apple IIe or Apple II+ under DOS 3.3 or Prodos. Apple's Macintosh machine uses the more compact Sony microfloppy drives, but the company has opted for the conservative 5.25in. drive on the IIc to preserve media compatibility. A third-party 10Mbyte hard-disc unit is available from Symbiotic Computer Systems.

Along the back of the machine is a carrying handle, which also functions as a stand to tilt the keyboard to a comfortable typing angle. Beneath it are the IIc's external interface sockets. The disc-

expansion socket lets you plug in a second 143K floppy drive mounted in a separate box. There are two RS-232 serial interfaces, one set up for connection to a modem, the other for a printer, but there is no parallel port. A socket for mouse or joystick is provided. The necessary circuitry and firmware to support a mouse is already built into the IIc, so adding a mouse is cheap. The Apple mouse costs £70 for the IIc, including the Mousepaint drawing program, as compared with £130 for the IIe, which requires an expansion card.

## Closed system

The IIc has no peripheral slots inside it for user-added expansion cards. This follows Apple's change in strategy toward more closed systems, first evident with the Macintosh. You are not meant to take the lid off. Apple says this is to keep things simple. Third-party suppliers will have to restrict themselves to making add-ons that fit the range of interfaces provided along the back of the machine. Whether this restricts the performance of add-ons for the IIc remains to be seen. The IIe is obviously the machine for people who want maximum hardware expansion potential above all else.



A half-height floppy drive is built into the side of the IIc. The monitor and mouse are optional.



Two output sockets are provided along the IIc's back plane for display: a standard video-monitor jack socket and a 15-pin D connector for RGB colour monitors. The IIc comes with a very neat matchbox-sized Pal TV adaptor, which you plug into the D connector and then to a domestic colour TV.

Regular business users may want to buy Apple's optional 9in. green screen monochrome monitor, which costs £140 and matches the IIc in styling. The monitor has separate brightness and contrast controls and gives a very stable image. A monitor stand is available for £27. It is not really necessary but it looks stylish and makes the setup more easily adjustable.

From the design of the IIc, Apple clearly envisages people taking the system home at the end of a working day, leaving the monitor on the desk and taking just the 7.5lb. main unit and the TV adaptor.

A third display option is promised for September. This is a flat-panel liquid crystal display, made for Apple by Sharp. Measuring 12in. long, it clips immediately above the keyboard and shows a full 24-line by 80-column display. Apple says that unlike existing LCD panels it is as fast as a normal CRT display, but does not say how this is achieved. The price is likely to be around £500. The display panel adds about 3lb. to the weight of the system, bringing it up to 10.5lb.

Inside the case is more evidence of Apple's intention to modify the IIc into a fully portable battery-powered product. The 128K of RAM is of the low power consumption CMOS type, as is the processor, the 65C02. CMOS technology has evolved to the point where there is no speed penalty associated with it, the 65C02 clocking at an acceptable 1.02MHz. The chips are soldered directly on to the main board, which should make the IIc good at withstanding the knocks that befall a portable.

Apple itself has not yet announced a battery pack for the system, but probably will. One independent company, Discwasher of Columbia, Missouri, has announced a fairly bulky video-style rechargeable power pack for the American market, with a claimed three- to five-hour duration.

Apple has not built a Z-80 compatible processor into the IIc, and does not yet have a Z-80 add-on card for it. There may be good practical reasons for this, but with many existing Apple II users running CP/M software it would seem a high priority. Independent third-party suppliers are already moving to fill this gap.

The standard operating system used by the IIc is Prodos, which has taken over from DOS 3.3 on all IIe machines currently being shipped, and has various advantages, particularly in terms of speed. Roger Cullis gives Prodos a full review on page 70 of this issue. Existing DOS 3.3 data discs can be used on the IIc; Prodos comes with a simple reformatting utility. Apple says the great

majority of programs will transfer across too. UCSD Pascal is available as an option.

The Applesoft Basic which comes in the IIc ROM is virtually unchanged. The IIc can display 16 colours, rather than the previous Apple IIe's eight, and higher resolution 560- by 192-dot graphics. The Basic allows for this while preserving full compatibility with existing Applesoft programs.

In line with other recent Apple products like the Lisa and Macintosh, the presentation of the Apple IIc is very good. The system comes with three manuals and five discs. The manuals are illustrated in colour and indexed. The main 142-page *Apple IIc — an interactive guide* is linked to tutorial programs on the discs, which describe the IIc hardware and Prodos, Applesoft Basic, Logo, and some typical Apple business packages and games.

You do not get working copies of Logo or Apple's integrated word-processing/spreadsheet/filing program Appleworks, but you do get demonstrations. Although this is obviously a sales device it should be helpful to people completely new to computing.

Apple has a sales target of 400,000 Apple II systems for 1984, the majority of them IIc machines, and can only hope to reach this figure by selling to people new to computing. In addition to its usual distribution channels Apple is talking to High Street multiples, and 30 branches of W H Smith are taking IIc machines on a trial basis. Apple sees sales in the U.K. breaking down on a roughly 60/30/10 percentage basis between the business, consumer and education market segments.

## Conclusions

● **The IIc gives the eight-bit Apple II design a much-needed shot in the arm. It is a compact and well thought-out system. Perhaps the Apple IIc's strongest card is the large amount of software immediately available for it, as it can run almost all programs developed for the existing Apple IIe system.**

● **The IIc is particularly suited to professional users, perhaps new to computing, who want a machine of practical business use that also has style.**

● **Compared to the Apple IIe the standard model IIc is good value, as it has more RAM, 128K, a full 80-column display, and disc and mouse controllers built in. On the other hand it is a less flexible system in hardware terms. Some specialised industrial and educational users may prefer the older IIe system.**

● **Mains-powered and using a separate monitor or domestic TV for its display, the IIc is semi-portable. However this is all most people want for transporting a machine between home and office.**

● **It looks very probably that a fully portable version of the IIc, battery-powered and with flat display panel, will be available by the end of the year.**

## Specification

**CPU:** eight-bit 65C02, a CMOS variant of the 6502, running at 1MHz

**Memory:** 128K RAM; 16K ROM containing monitor program and Applesoft Basic

**Display:** both 24-line by 40-column and 24-line by 80-column text modes; graphics modes — 40 by 48, 280 by 192, and 560 by 192; while preserving Apple IIe compatibility, the IIc has 16-colour rather than eight-colour graphics; the IIc outputs display through a domestic TV, a monitor or the promised LCD panel; standard system comes with TV adaptor

**Keyboard:** full-size QWERTY layout keyboard with 63 keys

**Discs:** built-in 143K 5.25in. floppy-disc drive, fully Apple II compatible; additional external 143K drive costs £230; third-party 10Mbyte hard-disc unit available from Symbiotic Computer Systems

**Interfaces:** mouse/joystick port, two RS-232C interfaces configured for modem and printer respectively, external disc interface, video-monitor jack socket, RGB output, audio socket

**Portability:** IIc main unit weighs 3.4kg, (7.5lb.) and is mains-powered via a power adaptor supplied with the system; main unit dimensions 305mm. (12in.) x 292mm. (11.5in.) x 64mm. (2.5in.) optional Apple IIc monitor weighs 5.5kg., (11lb.), optional flat-screen display panel about 1.4kg. (3lb.)

**U.K. price:** £925 plus VAT for IIc with 128K and one built-in disc drive, TV adaptor, power adaptor, Prodos and utilities, manual plus four tutorial and demo discs

**Hardware options:** Apple IIc 9in. green screen monitor, £140; monitor stand, £27; flat-panel liquid crystal display is promised for September 1984, price about £500, showing full 24 lines by 80 columns and high-resolution graphics; IIc mouse costs £70 including Mousepaint drawing package; rechargeable battery pack has been announced by third-party supplier in the U.S.

**Software:** IIc comes with the Prodos operating system, utilities, and six training programs on disc, and Applesoft Basic in ROM; the IIc runs Prodos software, and also most existing DOS 3.3 and Apple UCSD Pascal software without alteration; example products making full use of IIc graphics and memory include Appleworks, £175, integrated word processing/spreadsheet/database; Apple Logo II, £75; Microsoft Multiplan, £159

**Manufacturer:** Apple Computer Inc., U.S.A.; Apple makes the IIc at its plant in Ireland for the U.K. and European markets

**U.K. distribution:** Apple Computer (U.K.) Ltd, Eastman Way, Hemel Hempstead, Hertfordshire HP2 7HQ. Telephone: (0442) 60244. Available June 1984.

DISTILLED from the received wisdom of the years since DOS 3.3 was launched in August 1980, Prodos incorporates many features which will be of immediate value to users of the Apple IIe and II+. Among the most important of them are a hierarchical file structure, the ability to use hard discs, memory management and interrupt handling.

Prodos is the result of considerable research into desirable features of operating systems, unlike its predecessor DOS 3.3, which has evolved through successive versions from the 1978-vintage DOS 3. Prodos was finally launched this March and bears less resemblance to DOS than to rival operating systems such as Unix, CP/M and UCSD Pascal.

Apple's IIc is to be supplied with Prodos as standard, as are future IIe machines. The good news for Apple II owners with DOS 3.3 is that their machines will run Prodos without any ROM changes. Existing software can be operated side by side with Prodos software. Apple has stated that it will not continue to support DOS 3.3 after the end of this year.

There will be no problems with packages such as VisiCalc which have their own operating system, since they also follow the DOS hardware protocols. One advantage of Prodos is that it offers a substantial speed improvement over DOS 3.3. Timing tests indicate that files are accessed nearly six times as fast as the earlier operating system.

Prodos requires an Apple IIe or Apple II+ with at least 48K of RAM. It is not intended to function with an Apple II because it needs Applesoft Basic to be resident in ROM, although it could be patched to use a firmware card. Following current trends, Prodos is menu driven, and as a result there is little need to refer to the instruction manual after the fundamentals have been mastered.

The Prodos User's Pack contains an

# PRODOS

Apple's latest operating system for Apple II machines, investigated by Roger Cullis.

operating manual and a User's Disc, which comes in separate versions for 48K and 64K systems. To get the system up and running you load a disc and either switch the computer on or, with the IIe, use Ctrl-Reset-Open Apple keys to do a cold start.

Like all the menus on the User's Disc, the opening menu offers a Tutor option which gives specific information about the module you are using. The Prodos Filer is a module which lets you reorganise the information stored. One group of commands, called volume commands, works with the disc as a whole; another group, called file commands, operates on individual files. These utilities are used for such purposes as formatting discs, copying files from one disc to another and deleting files that are no longer required.

## Orderly system

In contrast to DOS 3.3, which is completely unstructured, Prodos lets you create a system of files with an ordered relationship to one another by means of path names up to 64 characters long. A path name is a series of file names, each preceded by a slash. The first file name is the volume directory, while successive file names indicate the path from the volume directory to the file.

A typical file family is shown in figure 4 and illustrates the hierarchical nature of the operating system. When a volume is first formatted it receives a name and a

directory. Anything that is saved on the volume is accessed through the directory. Directory files are special files that describe and point to other files on the disc. They may be read but not written to. All non-directory files are standard files which may be read or written. Access may be restricted by locking the file.

Another feature introduced by Prodos is that files are stamped with the date and time. If your Apple has a Thunderclock or Proclock card this process is performed automatically every time the file is updated. Other clock cards can operate in a similar way, but you will have to patch appropriate interfacing routines into Prodos. If you do not have a clock card it is a simple matter to set the date and time by choosing the appropriate option on the main menu.

Most users who install the Prodos system will already have software in DOS 3.3 format. Prodos copes with this problem by a conversion menu. Unlike the Muffin utility on the DOS 3.3 Master Disc, which changes DOS 3.2 to DOS 3.3 format, Prodos can carry out the conversion in either direction.

When the computer is cold started the bootstrap ROM on the disc controller card reads a loader program from sectors 0 and 1 of the Prodos disc into memory at \$800 and then runs it. The loader looks for a file called Prodos in the volume directory of the boot disc, loads it into memory at \$2000 and executes it.

A part of Prodos, known as the MLI or

```
*****
*
*          PRODOS USER'S DISK
*
*  COPYRIGHT APPLE COMPUTER, INC 1983
*
*****

YOUR OPTIONS ARE:

? - TUTOR: PRODOS EXPLANATION
F - PRODOS FILER (UTILITIES)
C - DOS <-> PRODOS CONVERSION
S - DISPLAY SLOT ASSIGNMENTS
T - DISPLAY/SET TIME
B - APPLESOFT BASIC

PLEASE SELECT ONE OF THE ABOVE
```

Figure 1. Main menu.

```
*****
*
*  APPLE'S PRODOS SYSTEM UTILITIES
*
*          FILER  VERSION 1.0
*  COPYRIGHT APPLE COMPUTER, INC., 1983
*
*****

? - TUTOR
F - FILE COMMANDS
V - VOLUME COMMANDS
D - CONFIGURATION DEFAULTS
Q - QUIT

PLEASE SELECT AN OPTION
```

Figure 2. Filer menu.

machine-language interface checks the memory size and relocates ProDOS. In a 64K system the main routines will be in the language-card area, with bank-switching routines and other housekeeping utilities in the system global page \$BF00 to \$BFFF. The memory map of a 64K ProDOS system is shown in figure 3.

The MLI is located in high RAM from \$D000 to \$EFFF with a data area from \$F000 to \$F800, while disc drivers are located at \$F800 to \$FFFF. Any avaricious programmer casting an eager eye on the alternate RAM card bank from \$D000 to \$DFFF are warned in the ProDOS Technical Reference Manual that this area is "reserved for future use".

ProDOS uses a simple form of memory management that allows it to protect itself and its data from being accidentally overwritten. It allocates 24 bytes of the system global page for a system bit map. One bit corresponds to each page of the bottom 48K of RAM, and as each page is used the corresponding bit is set. If a subsequent program wishes to use a page that has already been allocated to a file it must first close the file and clear the corresponding pages on the bit map.

ProDOS can make use of the additional 64K provided by the extended 80-column card, which it designates as a volume called /RAM, listed in the system configuration as Slot 0, Driver 2. It cannot, however, be accessed by slot and drive, only by path name. There is a small overhead associated with this RAM so about 63K, equivalent to 128 sectors, is available as user memory.

Apart from the areas of memory occupied by ProDOS itself and by the current program, 1K buffers are allocated dynamically as files are opened and closed during the course of execution. These buffers are located immediately below the system global page. If memory is required for user-installed routines, it should be allocated in the same way that ProDOS

allocates file buffers — by multiples of a 256-byte page that is placed 1K above Himem.

Possibly the most significant feature of the original Apple II was the provision of eight expansion slots, and an army of peripheral manufacturers has made use of them to connect devices for every conceivable application. To control these devices in a manner transparent to the end-user they perform operations on DOS that would do credit to a brain surgeon, delicately removing small sections such as the Init command to provide a few bytes for the interfacing routines. ProDOS provides for the addition of new commands and routines without resorting to such techniques. If ProDOS does not recognise a command, it makes a call to a location in

the global page which contains a vectored jump to the added command.

One of the ways in which existing Apple II systems show their age is DOS's inability to handle interrupts. ProDOS rectifies this by making provision for up to four interrupt procedures. The handling routines preserve the processor's registers, zero page locations \$FA to \$FF and 16 bytes of the stack, all of which are available if required to service the interrupt.

One consequence of ProDOS's ability to handle large files is that it can operate with disc systems much larger than the 143K provided by Disk II. The only modification required, apart from the obvious ones which control physical features of the drive such as timing parameters, is the need to record a status byte at specified locations in the disc controller ROM giving information about the characteristics of the device and two size-defining bytes which pass to ProDOS the total number of 256-byte sectors supported by the drive.

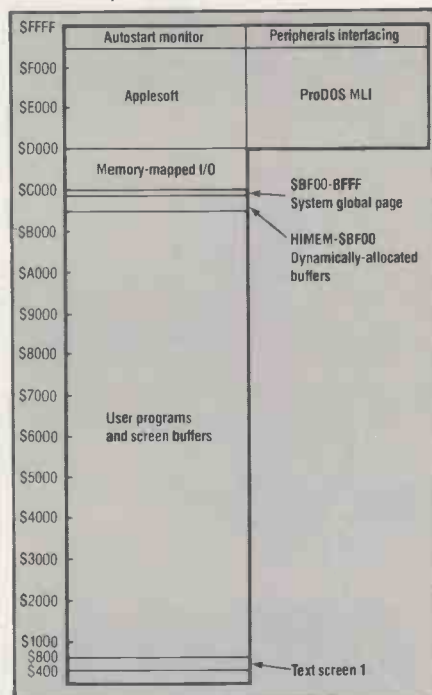

Figure 3. The memory map of a 64K ProDOS system.

## Conclusions

- ProDOS runs on existing Apple II machines which have 64K RAM, Applesoft in ROM and a DOS 3.3-compatible disc controller for 26-sector soft-sectored discs.
- It offers worthwhile improvements over the earlier Apple II disc operating systems.
- Applications programmers will be able to make use of structured files and automatic date and time stamping, together with faster disc access and the ability to use hard discs and RAM disc simulations.
- Until this new software emerges there will not be a great incentive for end-users to upgrade their systems unless they run programs with a great deal of disc access, in which case the increased operating speed is sufficient reason to make a change.
- The ProDOS User's Pack costs £35. A Technical Reference manual is available at £18 and the Programmer's Pack at £35.

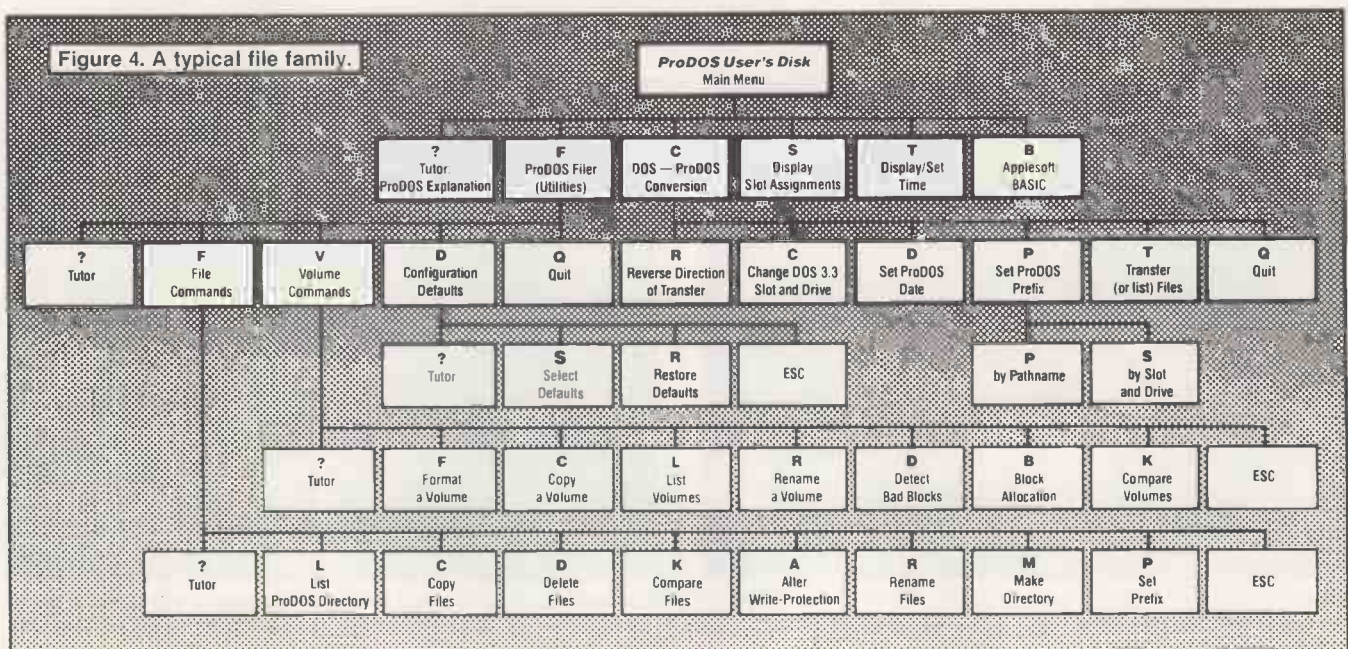

Figure 4. A typical file family.

# JANE

Arktronics' new integrated software is claimed to be easy to use on eight-bit machines. Ian Stobie discovers the price you pay for simplicity.

DICK, SPOT AND JANE are characters in a well-known series of children's books widely used in America to teach reading. Jane is also an integrated software package combining the three most popular business applications: word processing, spreadsheet analysis and record management. Arktronics, the company responsible for developing Jane, chose the name to emphasise its system's ease of use since the software package is very definitely aimed at first-time users.

At present Jane is available on the Apple IIe, with IBM PC, Commodore 64, Atari and Apple IIc versions imminent. The Apple version we review here costs £314 with VAT, a price which includes the Jane mouse and interface card. All versions of Jane will require disc drives and a reasonable amount of memory; the Apple version needs at least one disc and 64K of RAM.

## Beginners' dream

The presentation of the system is superb, and with a product aimed at absolute beginners this is important. Packaged inside a colourful box are a mouse and interface card, three floppy discs and the Jane manual. The mouse is easily installed by following the step-by-step photographic instructions provided. The discs are each a different colour to prevent confusion, with the grey System disc, black Data disc and yellow Help disc.

The Jane manual is the best I have seen for any computer product: it is both clearly written and easy to use. It is a small-format spiral-bound book 236 pages long, with frequent screen dumps printed in a contrasting colour to the text, and with two indexes. It starts with a tutorial section linked to example files contained on the

discs. The whole Jane system is then described again from the beginning in reference style. At the beginning of each new section a few pages summarise the most important points using large type and Jane symbols. I particularly liked the picture index, which enables you to go straight to an explanation of any Jane symbol.

To start the system you put the grey disc in drive 1 and the black data disc in drive 2 and turn on the computer. The drives whir and a row of 13 pictures appear along the top of the screen. The disc picture symbol lets you format and copy discs or

selected disc files, so the new Jane user has no need to also learn about the Apple's disc operating system.

The three largest icons are pictures of a typewriter, calculator and filing cabinet, which represent the word-processing, spreadsheet, and record-handling applications respectively. Also on the screen is a hand, with index finger extended, which is the pointer. It moves around when you push the mouse over the desk surface. Moving the mouse over the typewriter icon and clicking the mouse button causes the disc to whirl again, and a Janewrite window opens up on the screen.

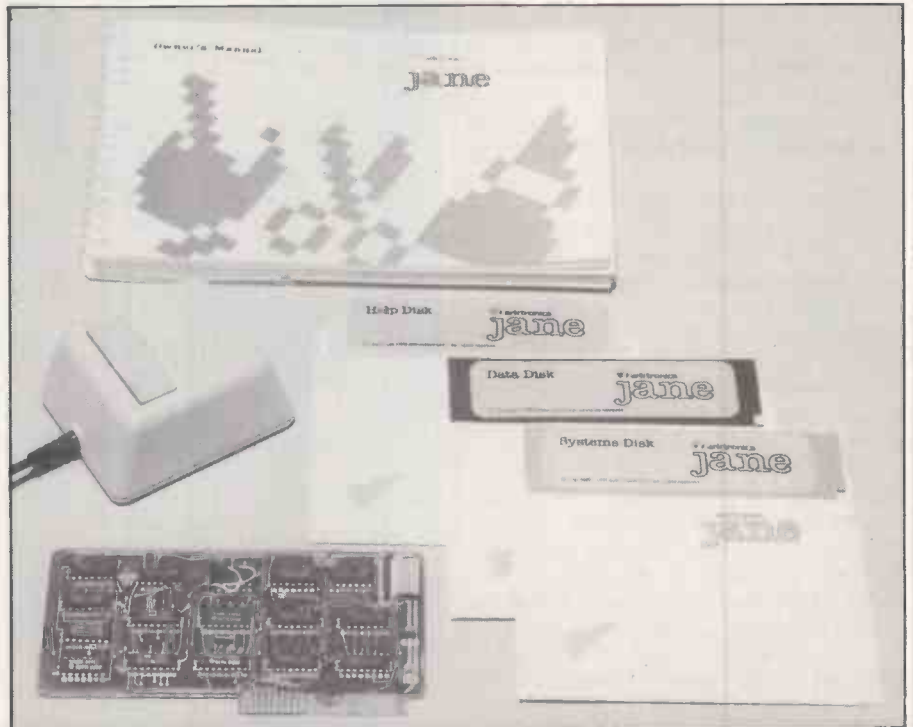

With Jane you get three coloured discs, mouse, mouse interface card and a manual.

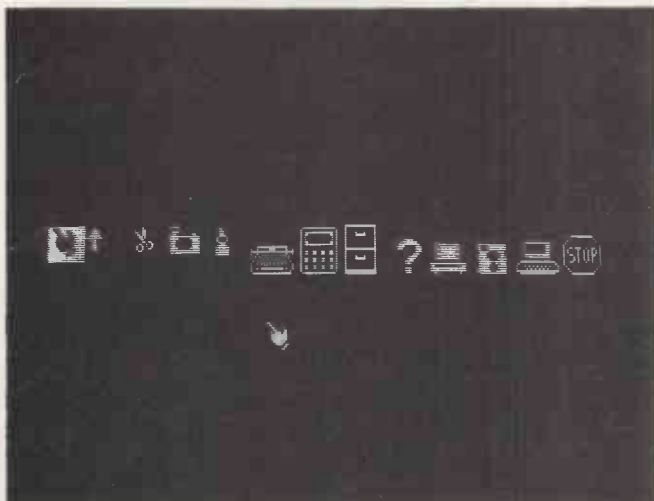

The opening Jane screen. The typewriter, calculator and filing cabinet represent the three core applications: Janewrite, Janecalc and Janellst.

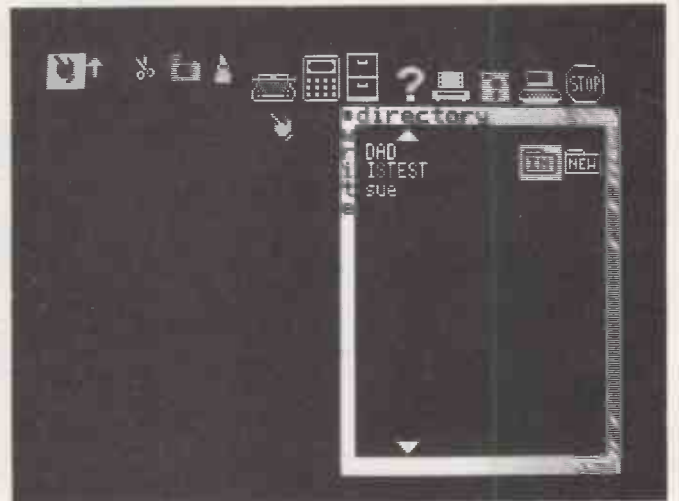

You use the hand to point to things, moving it with the mouse. Here Janewrite has been selected by pointing to the typewriter, and it is displaying a list of existing documents.



It shows you what word-processing files you have on your data disc. Moving the hand over a file name and clicking brings the appropriate document into memory and a window full of text fills most of the screen.

## Lisa-like

All of this sounds very like Lisa, with the mice, graphic icons and windows. In fact Jane is not up to Macintosh or Lisa standards, although the ideas behind it obviously come from the same place. Getting a multi-function package with a mouse and high-resolution graphics interface to run on an eight-bit system with 64K of memory is quite an achievement, but you do pay a price. Once you start doing anything like editing a document or calling up a new symbol Jane gets noticeably slow, as it is forever accessing the disc to bring in new chunks of your file.

Editing is straightforward and fun. You type in text in the normal way until you want to use one of Jane's editing tools. The insert arrow, the scissors, the camera and

the glue pot are all tools, arrayed as pictures along the top of the screen. To delete a chunk of text, for instance, you first move the pointer over the scissors and click, which changes the pointer from a hand into a pair of scissors. You then move the scissors to the start of the unwanted text and drag them over the whole unwanted passage with the button held down. On releasing the button the discs whirl and the text disappears.

The pointing, clicking and dragging procedure is used consistently throughout the different Jane applications. Moving columns in the spreadsheet or copying data in the filing cabinet works in a similar way to moving and copying in the word processor. The command sequence differs from that used in Apple's own mouse-driven packages for the IIe, Mac and Lisa, where generally you select your text or data before choosing the action to be done on it.

As an alternative to using the mouse, an appendix in the manual lists a complete set of control key commands covering all of Jane's major functions. Once you are familiar with the package, using just the

keyboard may well be the quickest way of getting things done.

Without bothering to leave the word processor, you can move the pointer over the calculator or filing cabinet to invoke Janecalc or Janelist. Clicking on the calculator symbol brings up another window over the top of the text document already on the screen. This is the Janecalc directory. As before, selecting a file will open a window with spreadsheet data displayed in it.

## Four windows

You can have up to four such windows on the screen at a time, not counting temporary windows like the directory windows which disappear once you have made a selection. You can copy text from one window to another using the scissors, camera and glue pot tools. It does not matter whether you are copying within documents of the same type or not: you can copy columns of numbers from a spreadsheet into a WP document.

*(continued on next page)*

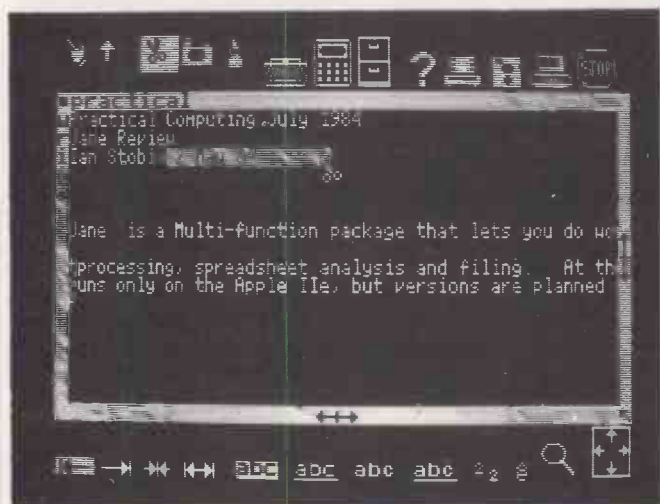

The scissors, camera, and glue pot are editing tools controlled using the mouse. They are for cutting, copying and pasting respectively. Here a phrase is to be cut from a document.

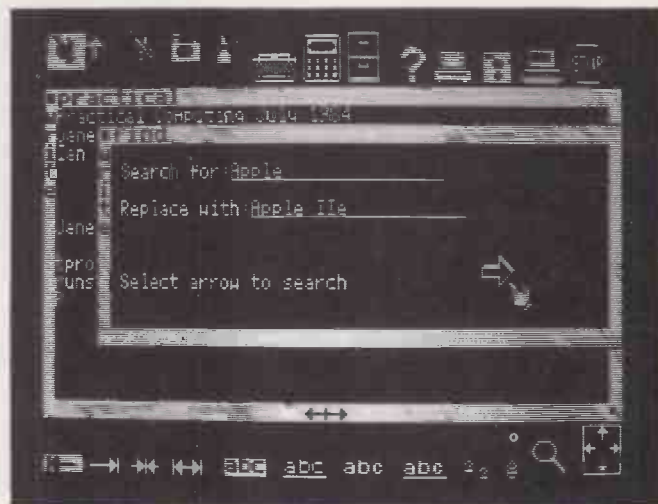

Along the bottom of the screen are symbols for text formatting, bold and underlined typefaces and foreign-language accents. Here the magnifying glass Search symbol has been selected.

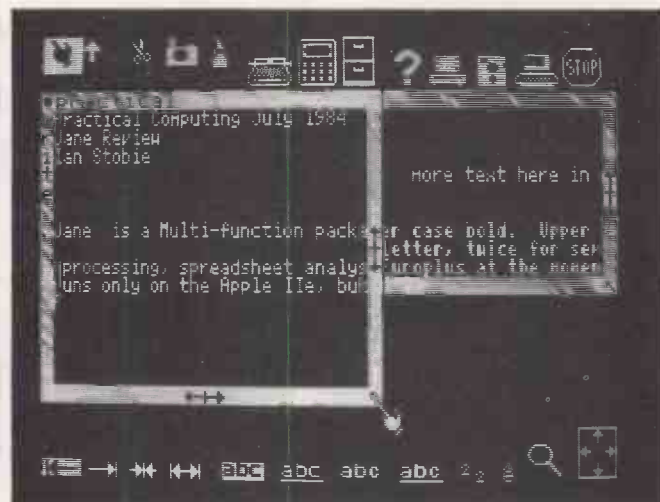

Like the more expensive Lisa and Mac systems it attempts to emulate, Jane gives you windows. Up to four different documents can be on the screen at a time.

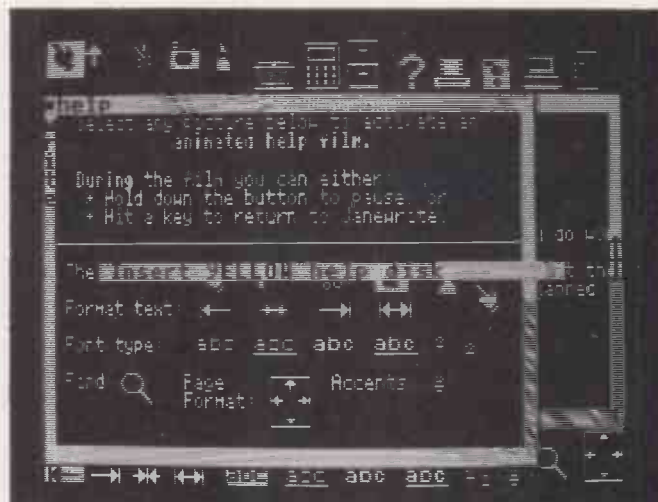

The display above comes up when you request help by pointing to the ?. You insert the yellow Help disc and then point to any symbol on the screen; an animated explanation then follows.

# JANE

(continued from previous page)

However, I was not able to discover any automatic way of doing this; you have to bring the source text or data on to the screen to copy it.

Janecalc is a straightforward rows and columns spreadsheet. A good range of arithmetic functions are displayed along the bottom of the screen for selection by mouse. You move around within the spreadsheet by clicking on the Left-Right or Up-Down arrows displayed on the solid lines framing the window.

Janelist, the application represented by the large filing cabinet icon, is a simple record-management package capable of handling a small mailing list or replacing a box of index cards. You can construct your own record-card format or use one of the two default ones provided. You then type your data into a blank record displayed on the screen. You can display or print all records or selected records, or sort them on different fields.

The selection criteria you are allowed are fairly simple — just matching on one or more fields. You cannot do more complex things like Less Than or Greater Than searches, or specify wild cards to match against. Like the rest of Jane, Janelist does enough to give the new user some ideas of the possibilities of computers, but you run up against limitations quite quickly.

Perhaps one of the features of the package that sums up what Jane is all about is the Help facility. Along with the other icons at the top of the screen is a large ?. Pointing at it at any time produces help related to what you are doing at the time. A screen prompts you to insert the yellow Help disc, and Jane then shows an animated sequence of screens showing you how to use the glue pot or whatever. It all happens quite slowly, but you are unlikely to be left not knowing what to do.

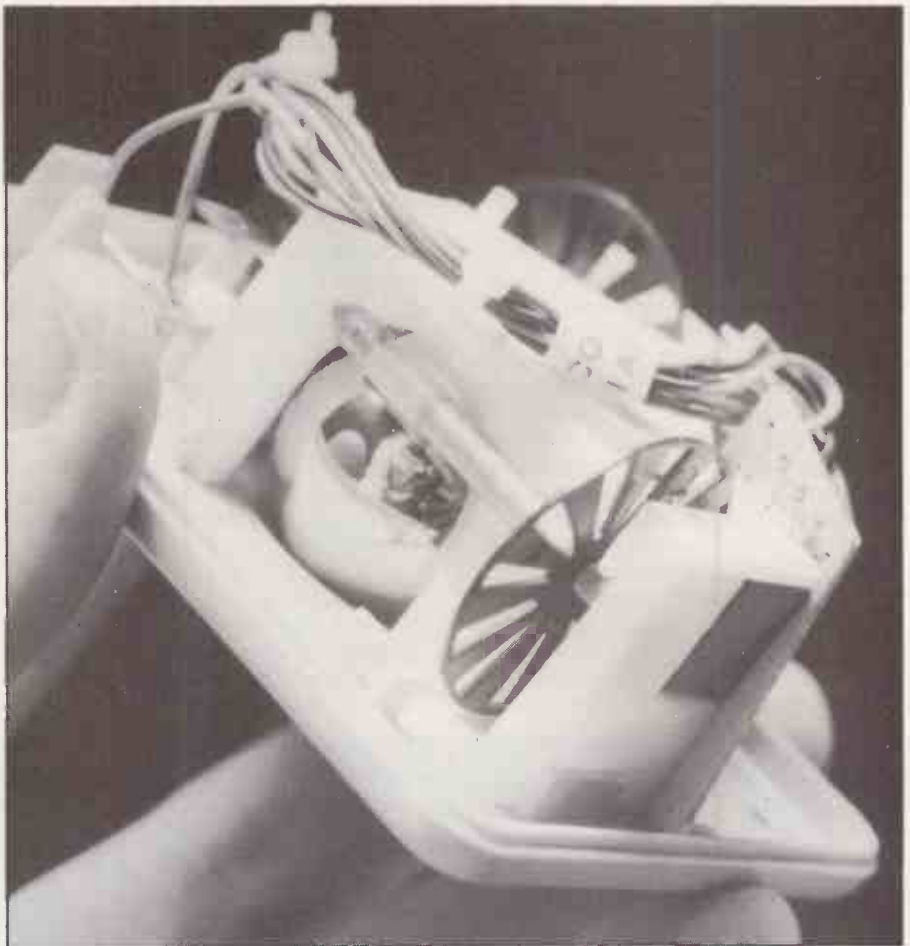

Inside the Jane mouse. Moving it over a desk causes the metal ball-bearing to rotate, and one or both of the plastic wheels to move. This movement is detected optically.

## Conclusions

- Jane is very easy to set up and use. The manual is a triumph of simplicity.
- Jane does not offer as sophisticated features as other multi-function packages like Appleworks or the Incredible Jack. It is often quite slow at what it does do.
- Jane is aimed at the first-time user, and it succeeds in its main goal of being very easy

to use. But once Jane's initial educational task is completed most users will want to move up to a more powerful but probably more difficult package.

● Judged in its own terms Jane succeeds. Whether £314 including VAT is too much to pay for a good introduction to the three major business applications — word processing, spreadsheet analysis and record handling — is up to you. □

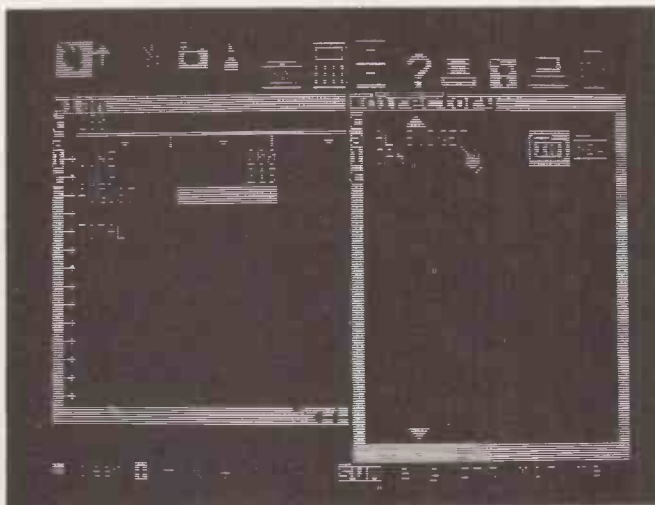

The Janecalc spreadsheet adopts similar conventions to Janewrite, using the scissors, camera and glue pot. Animated sequences explain the symbols along the bottom of the screen.

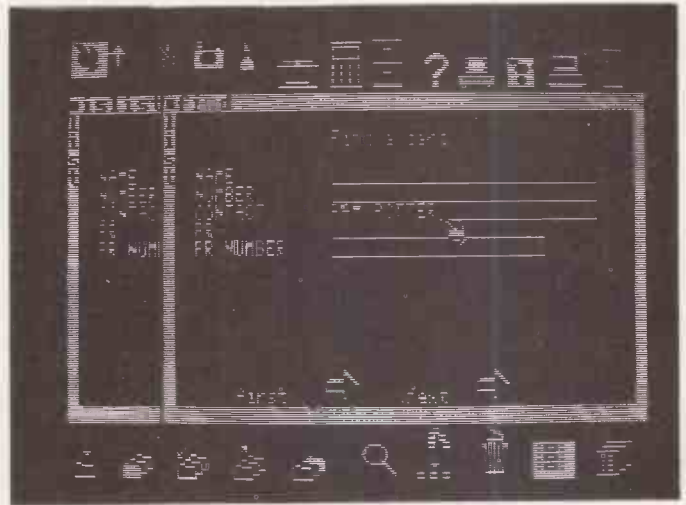

Janelist is the system's filing cabinet. You can create and maintain sets of record cards, and then print and sort records, or selectively search through them.

# HISOFT PASCAL DEVPAC

## Quality ZX SPECTRUM\* Software

### HISOFT PASCAL 4T

"... I haven't seen any other compiler that could match Hisoft's Pascal" ... Using the Spectrum Micro - Autumn 1983

"This is a very impressive product ... of benefit to any Spectrum programmer ..." David Bolton ZX COMPUTING Aug/Sept 1983

Just two comments from full length reviews of our powerful and virtually full implementation of Standard Pascal. The advantages of using Pascal are well-known - fast, self-documenting, and above all, structured programs and now, with Hisoft Pascal, you can reap all these benefits on a wide range of home computers, including the 48K Sinclair Spectrum! Hisoft Pascal produces programs that run typically 40 times faster than equivalent ZX BASIC programs and, sometimes, up to 1,000 times faster!

Hisoft Pascal supports FOR...DO, WHILE...DO, REPEAT...UNTIL, CASE...OF, INTEGERS, REALS, CHARACTERS, RECORDS, POINTERS, SETS, ARRAYS etc. etc. - it is not a Tiny Pascal but a virtually full implementation of the language allowing the user to develop true high-level language skills while attaining execution speed close to that of machine code. Complete with a 70-page manual.

### HISOFT DEVPAC 3

"... DEVPAC is most highly recommended. The documentation is first class." Your Computer May 1983

"... if you write programs in machine code, buy DEVPAC - it is the best currently on the market." Adam Denning, ZX SOFT in Which Micro September 1983

Two comments from reviews of earlier versions of DEVPAC - now we have DEVPAC 3 available: a powerful Z80 assembler with conditional assembly, assembly from tape (to enable generation of very large code files), ORG, EQU, DEFB, DEFS, DEFW, DEFM, labels of any length - in fact all you need for fast (3,000 lines per minute) and powerful assembly programming. But it doesn't stop there: DEVPAC 3 also includes an incredible debugger/dis-assembler giving you a 'front panel' display of the Z80 system and allowing extensive debugging of your machine-code program, including single-stepping programs EVEN IN ROM! Open up the secrets of low-level programming with DEVPAC 3.

Prices:  
Hisoft Pascal 4T (ZX SPECTRUM) £25 inclusive  
(NewBrain, SHARP MZ700 etc) £35 plus VAT  
Hisoft DEVPAC 3 (ZX SPECTRUM) £14 inclusive  
(NewBrain £25 inclusive)

\*\*\*STOP PRESS\*\*\* Hisoft Pascal for the SPECTRUM now comes complete with a Turtle Graphics package allowing fast and easy production of complex graphic displays

### HISOFT

180 High Street North  
Dunstable  
Beds LU6 1AT  
Tel: (0522) 696421



● Circle No. 149

# The NEW Apple IIc

Take it home  
for just £849

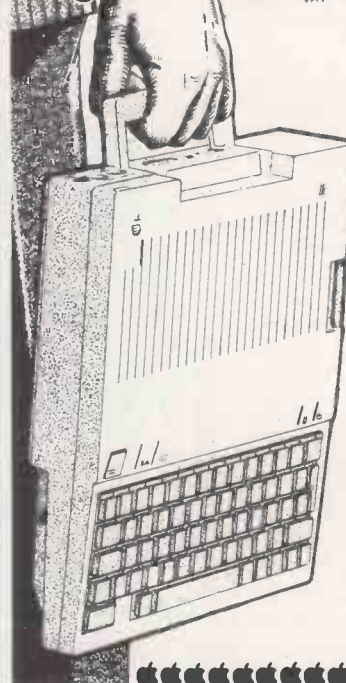

Full size keyboard but fits in a briefcase  
128k memory Apple II family compatible  
(Runs most Apple programs)

Built-in: -  
143k Apple 5 $\frac{1}{4}$ " disk drive and controller  
40/80 column display in upper & lower case  
Modulator for 16 colour graphic display for  
home TV or professional monitor  
Speaker & headphone jack with volume control  
Ports for Serial Printer and Modem  
Second Disk Drive socket

Weighing in at 7 $\frac{3}{4}$  lbs, the best all-in portable yet. For just £849 (VAT)

**you've got it in one.**

And you can plug-in lots of extras including: -  
2nd Disk Drive, Hard Disk, Network  
Mouse, Joystick & Hand-controllers  
Printer, Colour Plotter, Modem  
Professional Monitor  
Ports for Serial Printer and Modem  
Carrying Case, etc. etc

Supplied only after pre-payment. Allow 7-14 days for delivery and cheque clearance. Subject to availability. Delivery & Insurance if required (UK only) £111 - VAT. Total delivered price including VAT £989.

Come along for a demonstration

# Vega

Computers Limited

10 Essex House George Street  
Croydon CRO 1PH  
Tel: 01-656 8431, 01-680 4484  
Telex 943763

● Circle No. 150

# Do Rosco Limited Low, Low Prices

## PRINTERS

	OUR PRICE
<b>EPSON</b>	
RX80T.....	£209
RX80FT.....	£239
RX100FT.....	£399
FX80FT.....	£359
FX100FT.....	£479
DX100.....	£419
<b>BROTHER</b>	
EP44.....	£209
HR1.....	£545
HR15.....	£399
HR25.....	£695
HR35.....	£895
EM101.....	£849
<b>CANON</b>	
PW (80 col. NLQ).....	£299
PW (136 col. NLQ).....	£359
<b>JUKI</b>	
Daisywheel 6100.....	£339
<b>DISK DRIVES</b>	
Full height.....	£154
Half height.....	£164
Direct Drive (half height).....	£179

## PERIPHERAL CARDS FOR APPLE II

Rosco printer cards are C/PM, Pascal and Applesoft compatible, and have full graphic dump capability.

Printer (centronic).....	£38
Printer + 16k buffer.....	£89
Printer + 32k buffer.....	£99
Printer + 64k buffer.....	£129
Printer cable.....	£10
80 col. (not Ile).....	

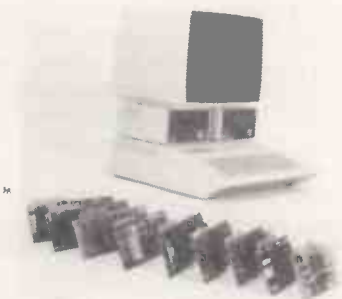

80 col. (Ile).....	£47
80 col. + 64k (Ile).....	£89
Disc controller.....	£32
PAL (+ modulator).....	£39

16k RAM.....	£36
EPROM writer.....	£44
RS232C.....	£37
Serial & Communications interface.....	£79
I/O interface (4 ports).....	£49
Z80 CP/M.....	£36
ASCII encoded keyboard u/case, l/case.....	£49
A-D 16 channels.....	£69
Real time clock.....	£49
Power supply.....	£49
AC, cooling fan.....	from £29
Joysticks.....	from £12
80 col. inverse chip.....	£6
40/80 col. switch.....	£9

## MONITORS

<b>SANYO</b>	
12" norm-res (green).....	£69
12" hi-res (green).....	£99
14" norm-res (RGB).....	£199
14" med-res (RGB).....	£349
14" hi-res (RGB).....	£499
<b>KAGA</b>	
12" hi-res (green).....	£109
12" hi-res (amber).....	£109
12" norm-res (PAL/RGB).....	£199
12" med-res (RGB).....	£259
12" hi-res (RGB).....	£359

P&P printers, monitors and computers £7. Others under £100 add £3, over £100 add £5. Please add 15% VAT to the total order. For full details and prices of all computers, monitors and printers ring: 021-356 7402 or write to: Rosco Ltd., 289 Birchfield Road, Birmingham, B20 3DD Telex: 334303 TXAGWM G

● Circle No. 235

# OPEN ACCESS

Paul Myerscough launches into Software Products International's all-in-one package for the PC.

SOME MONTHS AGO I was at a demonstration of the ever-popular dBase II package. In a back corner of the room a collection of hard-core IBM PC enthusiasts, bored with last year's software, were comparing notes on the latest offerings from the U.S. The presenters were understandably upset, for the competition was Software Products International's Open Access, one of a new generation of products that is all set to wipe some old favourites off the board.

Open Access provides file-management, spreadsheet, word-processing and graphic software, all designed so that information may easily be transferred from one function to another. Two further offerings add icing to the cake: communications software to support the use of a modem, and a time-management program that combines an electronic appointments calendar with an address book.

There are obvious advantages to an integrated package like this. As an independent consultant, I am typical of a small business user who has several needs that can be fulfilled by the right programs on a microcomputer. When my own IBM PC arrived my wish-list ran to about £2,000 worth of software, but now most of that can be obtained in one purchase for a much lower price. The passing of information automatically from file-management program to spreadsheet to graphics certainly saves effort, and a common user view across the different elements makes it easy to become familiar with a new function.

## Exemplary

SPI's presentation of Open Access is exemplary. Everything is fitted into a chunky box that sits alongside the IBM manuals. The documentation is well produced with good-quality print, layout and paper. A 75-page booklet *Getting Started* with its own disc of example files describes the configuration procedure and provides an hour-long tour of the main features of the package.

The 320-page ring-bound reference manual is supplemented by a 520-page user guide which includes expansive tutorial texts and its own disc. A 43-page pocket guide, two system discs and a plastic function-key overlay complete the picture. It was only when I tried to edit text created with another word-processing package that I realised the manuals do lack some technical information that I would find useful.

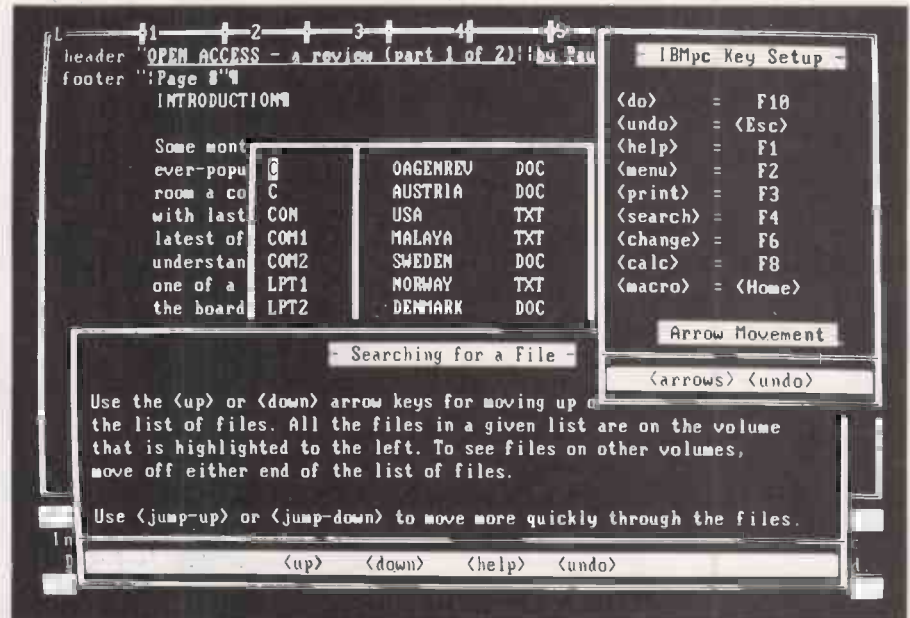

Two Help windows superimposed over the Search file and word-processor windows.

The software, which is ready to run on delivery, allows various defaults to be reset including the printer name, the decimal separator, the date format and logical devices for the Search function. The printer name references a table set up by the user, or one of 19 that are pre-configured. Thus it is easy to designate a printer call Rough when it has the characteristics of a fast dot-matrix, Letter as the same printer with double printing and single sheet feed, and Spool as a disc file. There are some 56 characteristics which may be entered for each printer and not all are described in the manual.

With so many functions in one package it is a challenge for the designers to implement a sound general user view of the software, but SPI seems to have achieved it. Rather than include a great complexity of function keys the overlay shows only eight, which are used in all modules: Help opens a scrollable window of information describing all the options available in a particular context; Menu transfers control back to an option menu; Print accesses a print program; Search is used to access a device directory from which a file may be selected, copied renamed or deleted; Change is used as a toggle between menus or option values; Calc provides a window to an on-line calculator; Do starts some action, often in response to a prompt on the screen, while Undo closes windows and lets you back out of options that are finished or which you chose in error.

In common with many modern packages, Open Access has a Macro learn/execute facility. In Learn mode all user entries are recorded and saved to disc; Execute provides a rerun of the learnt procedure. This is particularly useful when a report produced regularly requires the same sequence of extraction, sorting, merging and summarising data each time it is printed.

One of the more striking aspects of Open Access is its use of windows. The data operated on typically fills a large window covering most of the screen. Below this is a menu of usable options and system information. By selecting Help another window opens, partly overlaying the last, and shows help text and options. The last window opened always appears to be on top, and is the only active one; to access those underneath, the upper ones must first be closed.

## Security

Though the windows do not allow concurrent use of functions they provide a valuable feeling of continuity and security. Non function-key options are chosen by entering a keystroke like F for File; or by using cursor-control keys to move a video inverting bar across a menu and hitting Do when the required selection is highlighted.

The natural starting point for a reviewer is the word processor. In Open Access word processing operates on two types of file:

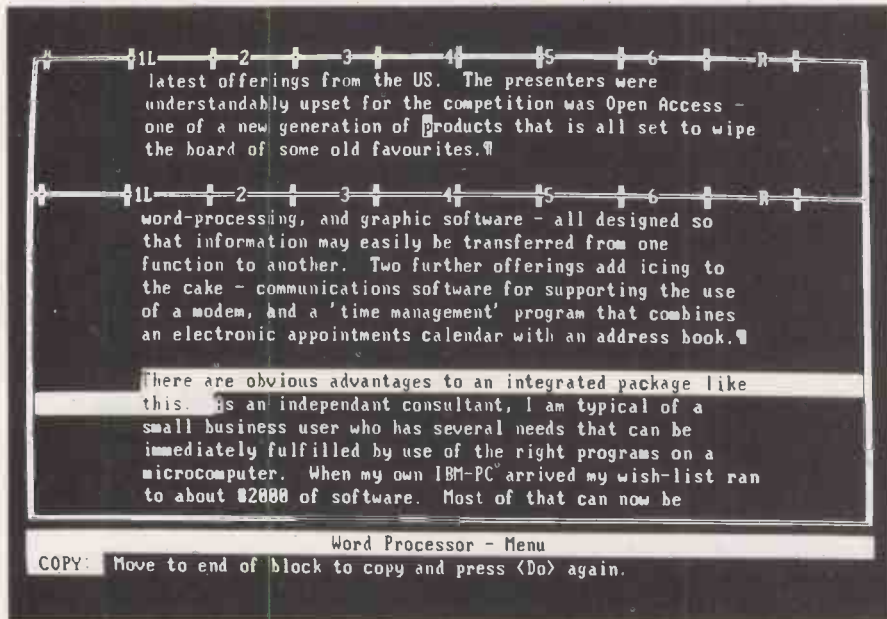

Open Access's use of windows makes copying text seem particularly secure.

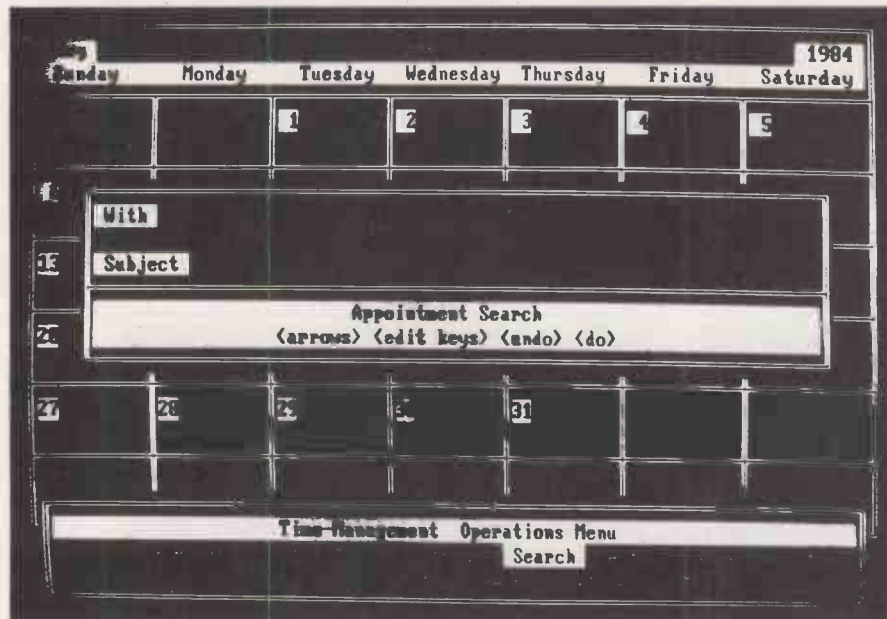

Time-management's calendar superimposed with the Appointments Search window.

documents, which provide typical word-processing flexibility, and text, which is a standard DOS file suitable for use externally by utilities or user-written programs. Text is held in memory during editing but as files may be merged together during printing this is not restrictive.

There are 20 cursor-control commands, allowing rapid movement around the text. They include jumps to next or previous character, word, sentence, paragraph, line, tabstop and so on. The calculator is always available in its window for a few quick sums in the middle of typing.

In some ways this is a mode-orientated word processor. New text is typed after Insert is selected from the main menu. The Backspace key can be used to delete a character, while larger pieces of text are removed by entering Delete mode. Here forward cursor movements delete text and

backward movements restore deleted text; the Undo key returns you to the position before you entered Delete mode. Exchange mode is used for overtyping.

Text is typed into a 19-line window, with a ruler across the top showing tab stops and margin settings. Margin and justification characteristics for up to eight paragraph types may be entered and, when selected from the Format option, cause the ruler and the paragraph at the cursor to be reformatted. Abbreviations may be set so that, for example, typing WP causes "word-processor" to appear on the screen. The table of paragraph types and abbreviations is sensibly stored along with the text so that options do not have to be reset every time a file is loaded.

Open Access's use of windows makes the Movetext and Copy processes particularly easy and secure. The top part of the screen

becomes a window on to five lines of the current text, including the destination point of the copy. The lower part shows the source, which may be the current text or a file read from disc. The start character of the source block is identified by a key entry, and as you move the cursor all the intervening text which is to be copied is highlighted. The Do command marks the end position, activates the transfer and removes the second window.

Within the word processor, Search is used for locating a position in the text. It is identified by the Setmarker command, or by typing a search argument of up to 77 characters for which a replacement value may be entered. This function operates in forward mode only and, when replacing text, provides an optional verification prompt.

## Type styles

From insert mode it is possible to set three type styles: bold, underline and italic. Newly entered text will then be given the selected attributes and appears in a different colour, or is highlighted on a monochrome screen. It is disappointing that you cannot change the style of existing text without retyping it.

The format of printed output is partly controlled by commands embedded in the text which are identified by ^ followed by a keyword like Header or Top Margin. Two header lines are available, and they may be aligned differently on left- and right-hand pages. There is also scope for a footer; line positioning; top and bottom margin setting; single, double or greater line spacing; page eject; page-number setting; blocking of text so that it appears together on one page; and the inclusion of separate files.

A feature I missed is the ability to embed ASCII character sequences needed to take advantage of printer options not otherwise available. The printer configuration menu does, however, allow the input of ASCII sequences for initialisation and type style.

The general Print option allows entries for paper width and length, output device — printer, screen or file — and start and stop pages for when only part of a document is needed. Printing is rather slow, as each line is simultaneously scrolled on the screen.

## Disappointment

Surprisingly for a multi-function package, printing cannot be run as a background activity while the screen is used for another purpose. Also, although I could align the header text to print position 132, the body of my text was printed as it appeared on the screen with a maximum line length of 77 characters. Nevertheless, the Open Access word processor is easy to use, and quick and efficient in moving and copying text.

(continued on next page)

(continued from previous page)

The time-management section of Open Access provides the elegant operation of what is essentially a simple file-based system. The basic display, created through program logic, is a six by seven grid that appears as a month page in a calendar. Each column is headed by a day of the week, and each cell is a box containing the date of the month and some space for typing in. If any entries are recorded on the display a record is saved to disc; otherwise the display is reconstructed when needed.

Appointments and reminder notes are kept separately and are created and retrieved in their own windows. Such windows are accessed by placing the cursor in a particular date cell on the calendar screen and selecting the options Make, to record an appointment, or Scratch, to make a note.

The List command provides a schedule for a day in 10-minute time intervals, showing the names of the people with whom appointments have been arranged against the start time. Additional logic highlights double bookings, prevents appointments outside working hours and during tea breaks, and lets you book multiple appointments in one go.

The address option puts a window, appearing like a deck of index cards, in the middle of the calendar. Here name and address details are recorded and accessed. This file, like other time-management files, is supposedly in what is called information-

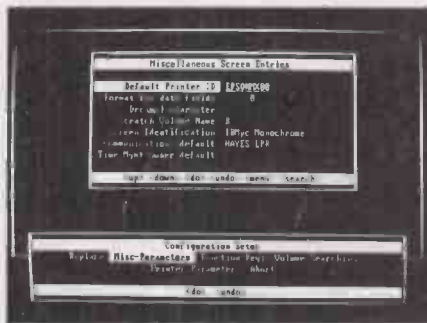

Windows are used to set up operating parameters.

## In brief

**System requirement:** PC-DOS 2.0 or MS-DOS 2.0; 192K RAM; two floppy drives or a hard disc; graphics card and colour monitor required for graphics  
**Price:** £495  
**Distributor:** Softsel. Telephone: 01-844 2040

management format, and hence can probably be merged into a mailshot letter, although the manual does not explicitly say this.

I have seen similar software in operation where employees located at different sites in the City of London may access each other's diary through a terminal. This system is used by an administration manager to schedule meetings without numerous phone calls, but it runs on a

multi-user system and serves a well-organised bureaucracy. I shall stick to my pocket diary.

Open Access's information-management function sets out to provide all that is needed to generate a custom-built file-based system. SPI claims superiority over some similar packages by the implementation of a structured query language. There is also a facility that relates files to each other through common data field values, which inevitably gives rise to the use of the term "relational database".

## Impressive list

It is claimed that the spreadsheet function will operate on a 216-column by 3,000-row matrix. As well as an impressive list of in-built maths and business functions, Open Access allows up to six windows to be displayed at a time, and provides a goal-seek function. Spreadsheets with a similar format may be consolidated, data may be transferred from one to another or collected from information-management files, and sent to the graphics function.

Communications is becoming increasingly important to IBM PC users. Is the modem control program a useful bonus? Well, yes and no! Next month I shall look in detail at information management and the spreadsheet with its graphics interface, and cover the yes and the no of Open Access's comms. 

# It's easy to complain about an advertisement. Once you know how.

One of the ways we keep a check on the advertising that appears in the press, on posters and in the cinema is by responding to consumers' complaints.

Any complaint sent to us is considered carefully and, if there's a case to answer, a full investigation is made.

If you think you've got good reason to complain about an advertisement, send off for a copy of our free leaflet.

It will tell you all you need to know to help us process your complaint as quickly as possible.

**The Advertising Standards Authority. **  
**If an advertisement is wrong, we're here to put it right.**

ASA Ltd, Dept 1 Brook House, Torrington Place, London WC1E 7HN

This space is donated in the interests of high standards of advertising.



# MICRO MARKET HELPS YOU GET MORE FROM YOUR MICRO

**010002 IBM PC CLOCK CALENDAR £89.22**

This Clock Calendar card comes complete with all software and needs no modification to IBM System Software.

**010003 IBM PC COMBINATION CARD £211.18**

The Combo II Card is a multi-purpose card for the IBM PC and XT and compatible Personal Computers, combining the functions of a parallel printer adapter, and a synchronous communications RS232 adapter, clock calendar and a games adapter on one card. No modification to IBM PC software needed.

**010004 IBM PC 512 K RAM CARD £211.18**

This RAM card provides the IBM PC and compatible Personal Computers, with the ability to increase Random Access Memory by 512K with one board. The RAM card is available populated in 64K increments from 64K to 512K bytes. The RAM card can also be directly connected to the Combo card to add both a RAM board and multi function board while using only one slot. Please state machine manufacturer and increment ie. IBM 64K to 512K.

**010011 IBM PC GAMES DISKETTE £29.42**

This disc containing many games for your IBM PC will help you relax after a hard days computing. Can be used with our combo card and joysticks.

**020012 APPLE Z 80 CARD £40.58**

This card allows Apple and Apple compatible computers to run Z80 CP/M based software opening up a vast new library of application packages.

**020013 APPLE 80 COLUMN CARD £62.76**

This card allows your Apple and Apple compatible to have 80 character X 24 line display using 7 X 9 dot character resolution. BASIC, PASCAL, and CP/M compatible.

**020016 APPLE DISC DRIVE £243.34**

Shugart mechanism disc drive fully compatible computers, single sided, single density. Disc controller board available.

**020018 APPLE 16 K RAM CARD £46.04**

This RAM card expands the internal memory of Apple and Apple compatible machines by 16K. 128K and 193K cards also available.

**030001 TRS 80 NEWDOS £166.43**

Version 2.0 NEWDOS is a high performance system. The versatility and sophistication of Version 2.0 includes features like, Double density support on Mod I, Enhanced compatability between Mod I and III, Triple directory size, Dynamically merge in BASIC, selective variable clearing, Automatic repeat function key, Enhanced disassembler, command chaining, and Fast sort function in BASIC.

**030016 TRS 80 MICRO CLINIC £29.42**

The ultimate in diagnostics for both memory and discs. Available for both model I and III, please state requirement.

**040001 ATARI 16 K MEMORY CARD £33.79**

This memory card will upgrade your ATARI 800 from 16K to 32K or 48K, simple installation instructions included, no alterations needed. British made.

**150001 PRINT SPOOLER £336.80**

The Spooler 64 is a 64K byte RAM, Z80 microprocessor based, printer buffer available with parallel interface. It will accept data from your computer at close to your computers processing speed and transmit it to your printer at a speed which your printer can accept. In this way the Spooler 64 will allow your programs to continue operation without having to wait for the printer.

**150005 SX 40 PRINTER £191.06**

The SX 40 printer is a low cost high performance 40 column thermal printer operating at in excess of 120 characters per second. The interface is switch selectable between serial; and parallel making it suitable for use with almost any business or home computer.

**150006 SX 80 PRINTER £301.58**

The SX 80 is a high quality matrix 80 column printer with friction and adjustable tractor feed as standard. A unique paper tray keeps paper feed and stacking simple. The parallel centronics interface is standard and a serial buffered interface is available. Full graphics and software compatability with Epsom range of printers.

**FOR FREE £5 VOUCHER** AND FULL DETAILS OF OUR MANY OTHER PRODUCTS AND TOP QUALITY REPAIR AND MAINTENANCE SERVICES SEND FOR OUR FULL CATALOGUE, POST COUPON BELOW OR PHONE 01 890 1440 FOR CREDIT CARD ORDERS.

PLEASE SUPPLY

PRODUCT NO.	DESCRIPTION	QUANTITY	PRICE
ALL PRICES INCLUDE VAT AND POSTAGE AND INSURANCE			TOTAL
I ENCLOSE CHEQUE FOR			

NAME
ADDRESS
TEL

PLEASE CHARGE MY ACCESS/BARCLAYCARD No.

# BRAINSTORM

This new software package aims to take word processing a step further and help users with the creative side of writing. Chris Bidmead sees if it lives up to its claims to be an ideas processor.

WORD PROCESSORS can take much of the clerical work out of putting words down on paper. But so far they have not met with much enthusiasm from creative writers of my acquaintance, many of whom think I must be something of an automaton for wanting to use this inhuman machine, the computer, to produce television scripts and books. For rather different reasons even business executives balk at using information technology to hammer out reports, feeling that by doing so they are identifying themselves with secretaries.

Caxton's Brainstorm could be the breakthrough that such kinds of people have been waiting for. Described as an ideas processor, Brainstorm is a software package that helps, so its authors say, with the creative side of text creation by making use of a concept called information hiding much used in the design of computer software.

Information hiding boils down to a commonsense idea. Big schemes like the writing of a novel, the building of a canal or the running of a business are often too complicated for all their elements to be considered at once, and need to be broken down into levels of abstraction. Each level can be considered as a whole in itself without having to take account of what is happening at the other levels.

Higher-level information can be safely ignored because it is purely organisational with respect to the current level. A token is used to represent the information on the lower levels and is said to be hiding the mass of otherwise confusing small detail.

Caxton suggests that effective creative thinking depends on the ability to organise ideas hierarchically, and so Brainstorm

allows sections of text to be hidden beneath single lines of text to an almost unlimited number of levels.

## Chunks of text

Such an approach is ideal for outlining. A typical elementary use might be to set up Introduction

What is "information hiding"?

How Brainstorm helps

Brainstorm's value In practice

Of course, any word processor will allow you to create this as an outer layer, and it is certainly a good starting point for kicking the ideas around. If ideas are to be processed they have to be put down in some tangible form, and there is no better way of doing this than the written word. So an ideas processor has primarily to be a good word processor, capable of moving chunks of text about as easily as you reorganise your thoughts. The ability to move the cursor quickly from one part of the text to the other is probably the most important single talent you need in software.

You also need to hide information. This is a feature that most word-processing systems have only in the rudimentary sense that an operating-system file name can stand for a mass of text in word processors where some form of the Include instruction is allowed. With a little rewriting the outlines mentioned earlier could be the file names in a directory

Intro.Txt  
Inform.Hid  
Brainsrm.Hlp  
Bvalue.Prc

But such an approach only gives you two levels of abstraction, and true information

hiding needs to go to many levels. So another essential feature is level juggling. Ordinary word processing manipulates text at a single level whereas information hiding structures text into a hierarchy of levels. These two elements represent respectively horizontal and vertical mechanisms. But in a useful system the two need to be consolidated so that text can be moved about between different levels, and the structure rejigged as necessary.

Brainstorm is easy to set up for most of the standard machines by running a compiled MBasic programme called Installb.Com. The review version of this installer had some bugs. For example, the defaults were incorrectly set up for one of the machines on the installation list, but the problems were as such that most moderately experienced computer users could deal with them.

On powering up, Brainstorm produces a box on the screen divided into three areas — see figure 1. The lower section is the command area, which consists of six lines of the screen permanently dedicated to displaying commands and prompts. Above that is an area where the current drive directory can be displayed. This area expands when you start to work on Brainstorm — see figure 2 — allowing you a 15-line window on the text you are creating. The area at the top displays a menu of commands available at this entry point. This part of the box shrinks when you enter text, to become the single line carrying the current title.

If you already have a file on disc you want to work on you can load it first with the L command — you cannot append its name to the CP/M command line in the

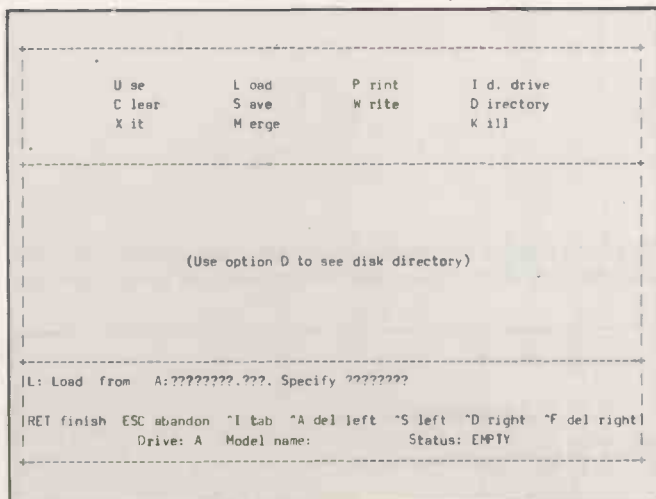

Figure 1. The opening screen.

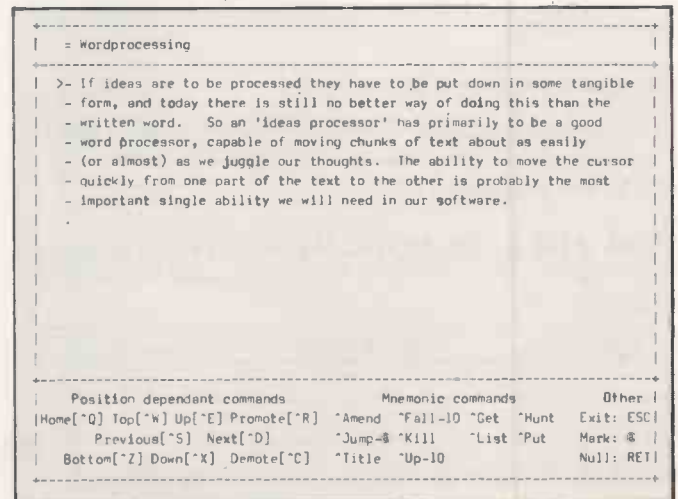

Figure 2. Up to 15 lines of text are displayed.



= Brainstorm

- Brainstorm is strong on the information hiding side, but is a moderate
- to poor word-processor (really a line editor with pseudo-screen-
- handling). There is some interesting juggling ability that enables
- stretches of text to be shifted from one level to another a line at
- a time, and text files can also be read into any one level from the
- disk.

@

Figure 3. Printout is not properly wordwrapped.

usual way — otherwise hit U, for Use, to enter the text editor. Irritatingly, Brainstorm initially assumes you want to work with drive A:; if you keep your data on drive B: you will always have to begin each Brainstorm session by reassigning the default explicitly.

Your first action with a new file will be to write a title for the whole opus into the one-line box at the top. The title area is important to the concept of Brainstorm, but the same is not true of the command area at the bottom of the screen, which continues to take up six lines — including two purely decorative rules lines — of valuable screen space whether you want it there or not.

## Instructions

Initially only the bottom line of the lower box displays useful information, namely the current line number, the number of lines in the text, the current level, and the amount of memory left. The rest of the space in the lower box tells you to enter text at line marked > and invites you to fill the rest of the box with the command menu by hitting the ! key. There would be some sense in this Cheshire cat of a crib sheet if, like WordStar, it gave you more room on the screen when it cleared.

So when you have entered a line at level 1 that summarises the general scheme of your project, a Carriage Return locks it up there and transfers your attention to the text-entry box. You then create your primary headings there, one for each line, and enter the next lowest level to create sub-headings. Otherwise filling out the details is done by moving the > mark against the chosen line and promoting it with the Control-R key. At this point, if there is no information hidden there already, the screen clears and the chosen line appears in the one-line title box at the top of the screen.

You can now go through the same process at this lower level, writing a series of secondary headings that are to be subsumed under the line in the title box. Then each of these sub-heads can be chosen, in any order, to have further details attached to them at the next lower level.

And so on, since there are over 60,000 levels.

Brainstorm works like a line editor. The difference is that any line may be a token hiding any number of other lines, which lends itself naturally to the idea of structuring text or one or more of the individual layers can be printed out on the screen, to a disc file or on to hard copy. This feature is confused by the use of ^L to List at the text-entry level, and P for Print at the outer-menu level. Partial printing appeared not to work as documented, and produced the remarkably silly line-wrapping in figure 3.

Brainstorm is strong on the information hiding side, but is a moderate to poor word-processor and really a line editor with pseudo-screen-handling. There is provision for getting around between the levels by searching for particular lines, or text patterns contained in lines.

Text files can also be read into any one level from the disc, but none of these processes happens at anything like the speed of thought. Extensive restructuring is very difficult. Once a Brainstorm structure has been written to disc it can only be read back into the system as a single level of text, unless it is tediously broken up into separate files first.

It is possible to create a kind of text macro by using the same heading in several places in the structure. Identical branches of the tree so created are called namesakes. A number will appear in the margin against each occurrence, signifying the number of namesakes of that line to be found in the whole structure. If you try to nest namesakes recursively the program responds by chopping the branch off at that point and denying access to any deeper levels.

On printout, or on writing out to disc, the same block of text will appear each time that heading is expanded. This could make Brainstorm useful for writing program code, though as an editor it lacks many of the essentials of a good source-code editor. There is no on-screen automatic indenting or numbering, backup files are not created, and it is not possible to create customised execution macros to simplify combinations of often used commands.

Brainstorm is not alone in the field of software that tries to do more with text than simply word process it. Two packages from the States, Thinktank and The Ideas Processor, TIP, also attempt to extend the manipulation of text into a tree structure.

Running on the IBM PC, TIP incorporates a flat-file data-handling system, a word processor and a graphics package. Its connection with Brainstorm is not as close as its name makes it sound, but its information handling is based on a hierarchy of cabinets, drawers and cards. Every card in the system can be subject to the full word-processing system, enabling you to search, replace and edit the cards just like ordinary text.

At \$295 from Ideaware of New York, the TIP integrated office package incorporating some information-hiding ideas seems very cheap compared to the limited facilities Brainstorm offers.

## Affinity

Thinktank is closer to the spirit of Brainstorm in the way it deals with structure. Thinktank begins at an outer outline layer. It allows you to move between the layers with a pair of instructions its creators, Living Videotext of Palo Alto, prefer to call Expand and Collapse. Where Brainstorm uses a = sign against a line that contains hidden depths, Thinktank puts + as a marker. Both use - to indicate a line with no further layers of information beneath it.

For \$195 for the IBM PC version Thinktank compares very favourably with Brainstorm. Considering the cost of its U.S. competitors it seems hard to justify the price of the British product.

## Conclusions

● Brainstorm certainly draws attention to an element missing from most ordinary word processors, and could prove useful for knocking out first drafts of documents. The package also serves as a simple-to-use text editor, and despite its limitations programmers may find it a helpful way of entering source code.

● To justify the grandiose title of ideas processor and its £300 price tag, Brainstorm's word-processing talents would have to be developed a lot further, to include at least true full-screen editing and block transfer.

● Brainstorm's menu system is geared for the rank beginner, but unfortunately is cemented into the package. It would be nice to be able to get rid of all the unnecessary extra boxes and work with a clear screen.

● A version of Brainstorm to run on the new lap portables, like the Tandy 100 and the NEC PC-8201, and priced for the lower-cost market would be a real boon. As it is positioned at the moment, pitched against very sophisticated software in the CP/M and MS-DOS market, Brainstorm is an overpriced, limited package. □

# Squaring up to

ONE OF THE unique aspects of programming a computer to play chess is that concrete methods exist for calibrating the success or failure of the program. The quality of a computer program is usually conveyed in purely descriptive terms: the graphics can be described by a plethora of adjectives, the entertainment value of a video game program can be assessed subjectively by a reviewer, the usefulness of a spreadsheet package can be measured by a combination of the features offered and the limitations imposed on the user. But all of these methods lack objectivity to a greater or lesser extent.

## Strongest wins

In chess it is relatively easy to determine whether your program is stronger or weaker than someone else's. You simply play a series of games between the two programs and the program which wins the series can reasonably be assumed to be the stronger. In the same way it is possible to compare the strength of a chess-playing computer program with that of a human player.

Another method of quantifying the strength of a chess program is the numerical rating scale which is normally used to rate human players. Chess enthusiasts who play reasonably often in tournaments or other chess competitions will have a rating on a scale that ranges from around 1,000 to around 2,800. The average of all humans who know how to play chess has been estimated at 800 points on this scale, and at the other end of the range Bobby Fischer had a rating of around 2,800 when he quit active play in 1972.

One way of monitoring the progress of computer chess is to plot the numerical rating of the world's best program against another variable, which might be the year in which this rating was achieved or some indication of the computing power involved. Computing power could be measured in terms of the number of chess positions examined per second by the program, or it could be a function of the number of instructions per second executed by the computer.

For the past 15 years chess programmers have been aspiring to various clearly defined goals. One obvious target is to write a program that can win the human World Chess Championship, and this was once defined by a group of eminent academics as being one of the 10 fundamental aims in the science of artificial intelligence. So far this goal has always been at least a decade or two away but other goals have proved to be achievable.

An American foundation set up by Professor Fredkin at Carnegie Mellon University has offered various cash incentives to chess programmers. One of them was a \$5,000 prize to the first program to achieve the rating of 2,200, which automatically qualifies human players as a National Master. This prize was collected last October by a program called Belle written by Ken Thompson and Joe Condon at the Bell Labs in New Jersey, which achieved an official U.S. Chess Federation rating of 2,203.

My own role as a target for chess programmers dates back to August 1968 when I started a bet that no program would win a match against me within 10 years. The bet was with Professors Michie, McCarthy, Papert and Welcher-Kozdrowicki. In August 1978 I duly played a six-game match against the reigning World Computer Champion, Chess 4.7, and won the match with three wins, one draw and one loss.

It seemed unsporting to remove the target that so many chess programmers had been aiming at for a decade, so shortly after the contest I decided to offer a prize of \$1,000, which was augmented by another \$4,000 from *Omni* magazine. The prize will go to the authors of the first program to win a match against me, no matter when that happens. The match must be played under strict human chess conditions, and must be of a reasonable length in order to reduce the possibility of luck being the decisive element.

## \$1,000 bet

I also made another bet, that I would not lose such a match before the beginning of 1984. The bet was with Dan McCracken, a past President of the Association for Computing Machinery, who is famous for his prolific writing on Fortran and other computing subjects. This bet was for \$1,000, and at the time I made it I considered it to be very much an even-money prospect.

At around the same time I gave up competitive chess against humans. During the five years or more that have passed since then I have not played one single competitive game of chess while the best chess programs have become stronger. In 1983 a program named Cray Blitz, written by Bob Hyatt and Bert Gower at the

David Levy, a retired chess Master, is now chairman of Intelligent Software, which has produced chess programs for popular micros and dedicated chess computers

University of Southern Mississippi and Harry Nelson of Cray Research, won the World Computer Championship in New York in a very convincing manner, finishing with four and a half points from five games and standing one and a half points aloof from its predecessor, the redoubtable Belle.

Following the success of the program in New York, Robert Hyatt announced that he wished to challenge me for the \$5,000 prize. I viewed the prospect with a mixture of interest and trepidation: I relished the challenge of trying to fight off the monster, but was very concerned that my five and a half years of inactivity would have left me so rusty that I might get wiped out by the program.

## London venue

After various attempts to find a suitable venue for the contest we agreed to play in London during the Advances in Computer Chess conference held in the middle of April. This was made possible by the sponsorship of *Practical Computing* and of GEC Dragon. The match was organised by Don Beal and play was via an open telephone line between London and Minneapolis, where the \$15 million Cray XMP computer was located. The Cray machine is undoubtedly the world's most powerful commercially available computer, and when occupied with tasks less interesting than playing chess its time is charged out at \$50,000 per hour. For the match two Cray processors were working in parallel for much of the time, so my one brain was struggling against two computer brains.

The first problem to face me as the match drew near was how to get back into practice overnight. I was fortunate to enlist the help of U.S. Master Danny Kopec, who is not only a player of international calibre but also an expert on computer chess. Danny agreed to act as my second for the match and arrived in London three days before the start to help me get match fit. We spent those days playing numerous speed games in which I managed to score no more than 25 percent, and we devoted a few hours to discussing my strategy for the match and what openings I ought to adopt.

In the first game of the match our opening strategy proved successful. I achieved a position which although objectively inferior from the human point of view, was very difficult for the program to understand. It made one or two errors which relinquished its advantage and then accepted my offer of a pawn, after which I

(continued on page 84)

# the Cray

This spring David Levy fended off a challenge from the World Champion chess program. Here he tells how he did it, and why humans should still have a year or two at the top.

## Game 1

April 14, 1984

White: Cray Blitz  
Black: David Levy

### MODERN DEFENCE

- 1 e2-e4 a7-a6
- 2 d2-d4 g7-g6

Taking the program out of its openings book at about the earliest possible stage. This was part of our pre-match planning, designed to take advantage of the fact that programs do not understand the finer points of chess opening strategy. The program's next few moves are natural but stereotyped.

- 3 Ng1-f3 Bf8-g7
- 4 Nb1-c3

Possibly inaccurate. In our pre-match analysis we had considered 4 c2-c3 to be best, supporting the d4 pawn and depriving Black of any Q-side counterplay based on the thrust ...c7-c5. However, we had expected Cray Blitz to play the text move, which develops a minor piece.

- 4 ... b7-b5
- 5 Bf1-d3 Bc8-b7
- 6 0-0 d7-d6
- 7 Bc1-f4 e7-e6
- 8 e4-e5

Part of Black's wierd-looking opening idea is to develop his knights on e7 and d7 and to meet the advance e4-e5 with ...d6-d5, followed by an eventual ...c7-c5, or the advance d4-d5 with ...e6-e5, followed by an eventual ...f7-f5. With the pawn centre locked the program will find itself in the type of position it handles least well.

- 8 ... d6-d5

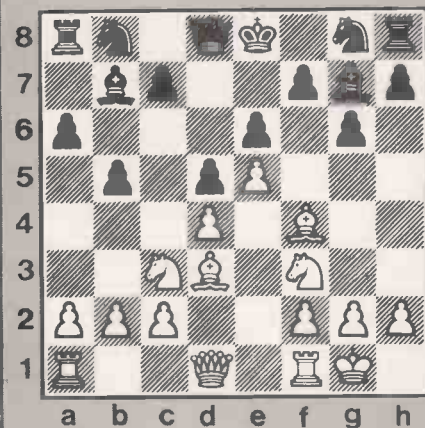

- 9 b2-b4!

When the program played this move my first reaction was that it had to be a

mistake, since it cedes Black control of the c4 square and creates long-term prospects for the g7 bishop along the h8-a1 diagonal. But on closer inspection I realised that Cray Blitz now had a clear positional advantage, partly based on the coming plan of a2-a4 and partly because of the possibility Nf3-d2, Nd2-b3 and Nb3-c5 — or Nb3-a5 in some positions.

- 9 ... Nb8-d7
- 10 Qd1-d2 Ng8-e7?!

Better might have been 10 ...h7-h6 first, and only then ...Ng8-e7.

- 11 a2-a4! c7-c6

There are now three ways for White to handle the tension on the Q-side. (a) Maintain the tension by keeping the pawn on a4 and preserving all options. In this case I had intended ...Ne7-c8 and ...Nc8-b6. (b) Closing the position with 12 a4-a5 in order to kill any prospects of Q-side play for Black. (c) Release the tension at once, and at the same time give Black's b7 bishop a new lease of life and leave White with a potentially vulnerable c-pawn on the half-open file. Cray Blitz chooses the third and weakest of these possibilities.

- 12 a4 x b5? c6 x b5
- 13 Bf4-h6 0-0

On 13 ...Bg7 x h6?? 14 Qd2 x h6, Black has no way to save the h-pawn against the dual threats of Qh6-g7 and Nf3-g5.

- 14 Bh6-g5?

Wasting a tempo. White should probably have traded bishops on g7 in order to try to set up an attack on the dark squares around my king.

- 14 ... Rf8-e8
- 15 Ra1-a3!?

Another occasion on which my first reaction was that Cray Blitz was floundering, but the real point of this move lies not in any attempt to control the a-file but in the possibility of switching this rook to h3 as part of an assault on my king.

- 15 ... Nd7-b6
- 16 Nc3-d1 Nb6-c4
- 17 Bd3 x c4 d5 x c4

Now that my b7 bishop has real scope, White must take care. 18 Nd1-e3 would allow 18 ...Bb7 x f3 19 g2 x f3 Qd8-b6, with a perfectly reasonable position for Black.

- 18 Nd1-b2?!

A strange square for the knight, and one from which it has no genuine prospects, but it is already difficult to suggest a good plan for White.

- 18 ... Qd8-c7

Now Cray Blitz has the unenviable choice between trading on e7, thereby giving me a potentially won endgame because of having two bishops against two knights, or permitting my knight to jump into play on f5 or d5.

- 19 Rf1-a1 Re8-c8



Now 20 ...c4-c3 is a serious threat, and 20 Bg5 x e7 is too late because of 20 ...c4-c3 21 Be7-d6 c3 x d2 22 Bd6 x c7 Rc8 x c7 and 23 ...Rc7 x c2.

- 20 c2-c3?

20 Nb2-d1 was forced, but it is easy to understand why Cray Blitz did not fear the ensuing continuation. Black can only capture on f3 at the cost of losing a pawn, which no materialistic computer program would ever sanction. An 11-ply search ending with 25 Ra5 x b5 would conclude that White was a pawn ahead, which is true but totally irrelevant.

- 20 ... Bb7 x f3
- 21 g2 x f3 Ne7-f5

Black cannot save both the knight and the a6 pawn.

- 22 Ra3 x a6 Ra8 x a6
- 23 Ra1 x a6 Qc7-b7
- 24 Ra6-a5 Qb7 x f3
- 25 Ra5 x b5

Cray Blitz has won its pawn, but at what cost! Its K-side is full of holes and in the long term it will not be able to defend against the combined attack from my queen and knight.

Botvinnik once wrote that the chess player's greatest art lies in creating positions in which the normal relative values cease to exist. One can extrapolate from his assertion by saying that the art of defeating chess programs easily lies in creating positions where the program's evaluation function fails to account for the true relative values as perceived by a human chess master.

(continued on next page)

# Squaring up to the Cray

(continued from page 82)

was able to launch a winning attack against its king.

When the second game was due to begin the computer was down, and after generously giving the program a five-minute period of grace, I started its clock. The computer did not come up during the next hour and so the program was declared to have lost by forfeit. The laws of chess state that the player who arrives at the board more than one hour late loses the game.

## Friendly match

About half an hour after the game was over the Cray came alive, and in the interests of science it was decided to play the game as a friendly encounter, without it affecting the score in the match. We played at a slightly faster than usual rate of 40 moves in 1 hour and 45 minutes rather than the normal two hours, and I was able to crush the program with a steady steam-rolling attack against its castled king.

After the second game was over the Cray Blitz programmers decided that they needed to discourage their program from allowing blocked pawn formations in the centre, as this had occurred in the first two games and was disadvantageous to the program. The point is that when the pawn structure is blocked there are no open lines on the board, and without open lines it is extremely difficult for a program to create play. In contrast, a strong human player can manoeuvre slowly in a blocked position, and open things up at just the right moment.

## Resigned

In game 3 I played in an almost identical manner to the first game. I varied my opening play very slightly, just in case the programmers had got a human expert to improve on the program's opening library in such a way as to take advantage of me. But soon it was clear that the program did not want to advance a centre pawn as it had done in the first game. I therefore decided to embark on a king-side expansion, and immediately the program made an unsound sacrifice which left me with a winning material advantage. A few moves later the computer crashed, whereupon the programmers resigned the game.

I was able to play the fourth game in

quite a relaxed frame of mind as I had already won the match. I adopted the same opening strategy as in the third game, but with an extra move on account of having white. My first plan was to give the program the opportunity to make the same unsound piece sacrifice as in game 3, but when the crucial moment came it became clear that the programmers had discovered what was responsible and had altered the program overnight.

I allowed my king-side pawns to become ragged, in an attempt to create attacking changes against the program's king, and once again I reached a position which, from the point of view of a strong human player, was rather undesirable. I permitted the program to give up a piece for three pawns — an even material exchange which left the program with good long-term attacking prospects against my exposed king — but I had counted on the program being eager to trade queens since it thought, quite rightly, that it had the advantage.

What the program did not know was the reason that it held the advantage lay largely in the fact that with queens on the board my king was vulnerable, whereas without queens the position offered me excellent prospects in the endgame. The program duly exchanged queens at the first opportunity, and after that its position went steadily downhill.

## Vital training

I was pleased to have won the match four-nil, especially in view of my rustiness. The work that I did with Danny Kopec before the match had played a big part, and when the next challenge comes I shall again go into training for a few days. The four-nil score does not truly reflect the difference in strengths between the two participants, but it does show the extent to which a good knowledge of how computers play chess can help a human player. The programmers were unlucky to have had so many hardware crashes during the match and displayed great sportsmanship despite their disappointment.

But even without hardware problems, I don't think Cray Blitz would have scored any points against me. That it not because I consider myself so very much stronger than the program, but because it does not yet have the ability to create the type of position in which it plays best. The day is not yet here when I must finally admit that the world's best computer program can beat me, and I can probably survive another two or three years before paying out the prize money.

I am told that in 1986 there will be a Cray system 20 times as powerful as the one used in my match, in which case the program will be able to look another two or three ply further ahead. That may or may not be sufficient to beat me, but even if I do lose there are another 400 points to go before the world's best chess programs are as strong as the human World Champion. ♞

25 ... h7-h6

The spectators now expected 26 Bg5-f6, when 26 ... g6-g5! is very strong. The program finds a better defence.

26 Bg5-f4 Qf3-h3!

Since 26 ... Nf5-h4 allows 27 Kg1-f1, I wanted to keep the white king under lock and key.

27 Bf4-g3 h6-h5  
28 Rb5-c5! Rc8-a8  
29 Qd2-c1??

This move protects the back rank against incursion by my rook at a1, and prepares for Qc1-f1, but the defence is inadequate. If the program had not been moving rather quickly it might have found 29 Rc5-a5!, when 29 ... Ra8 x a5? 30 b4 x a5 leaves White with a dangerous passed pawn, while after 29 ... Ra8-f8 30 Nb2 x c4 Bg7-h6 31 Qd2-a2 h5-h4 32 Ra5-a8 h4 x g3 33 h2 x g3, it is not exactly clear whether Black's extra bishop is more or less than a match for White's extra pawns. In a game against a computer program I would expect to win with Black, but against a human player I would be much more concerned about the hoardes of advancing pawns.

29 ... h5-h4

After the game Danny Kopec pointed out the beautiful win 29 ... Bg7-h6 30 Qc1-f1 Nf5-e3!! 31 f2 x e3 Bh6 x e3 + 32 Bg3-f2 Qh3-g4 + 33 Kg1-h1 Qg4-f3 + 34 Kh1-g1 Be3 x f2 + 35 Qf1 x f2 Ra8-a1 + etc. My move is far less exciting but just as effective.

30 Bg3-f4 Qh3-f3  
31 h2-h3

The only way to prevent 31 ... h4-h3 without losing the bishop.

31 ... Qf3 x h3  
32 Rc5 x c4 Qh3-f3

Echoing the threat of ... h4-h3, which this time cannot be stopped.

33 Bf4-h2

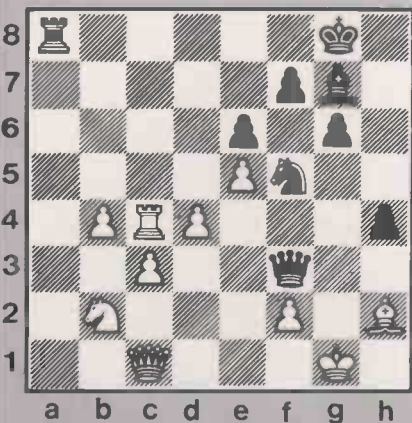

33 Kg1-f1 loses the queen to 33 ... Ra8-a1! 34 Qc1 x a1 Qf3-h1 +, and 35 ... Qh1 x a1.

33 ... h4-h3  
34 Qc1-f1 Ra8-a1  
35 Nb2-d1 Ra1 x d1

White resigns.

# Without the right program your computer could take a dim view of your accounts.

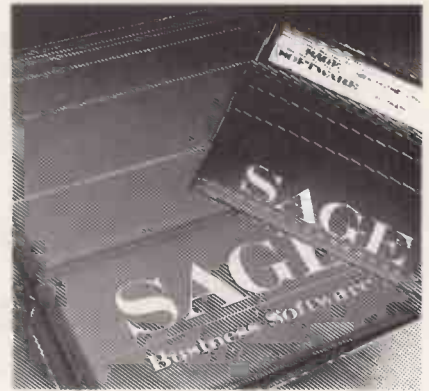
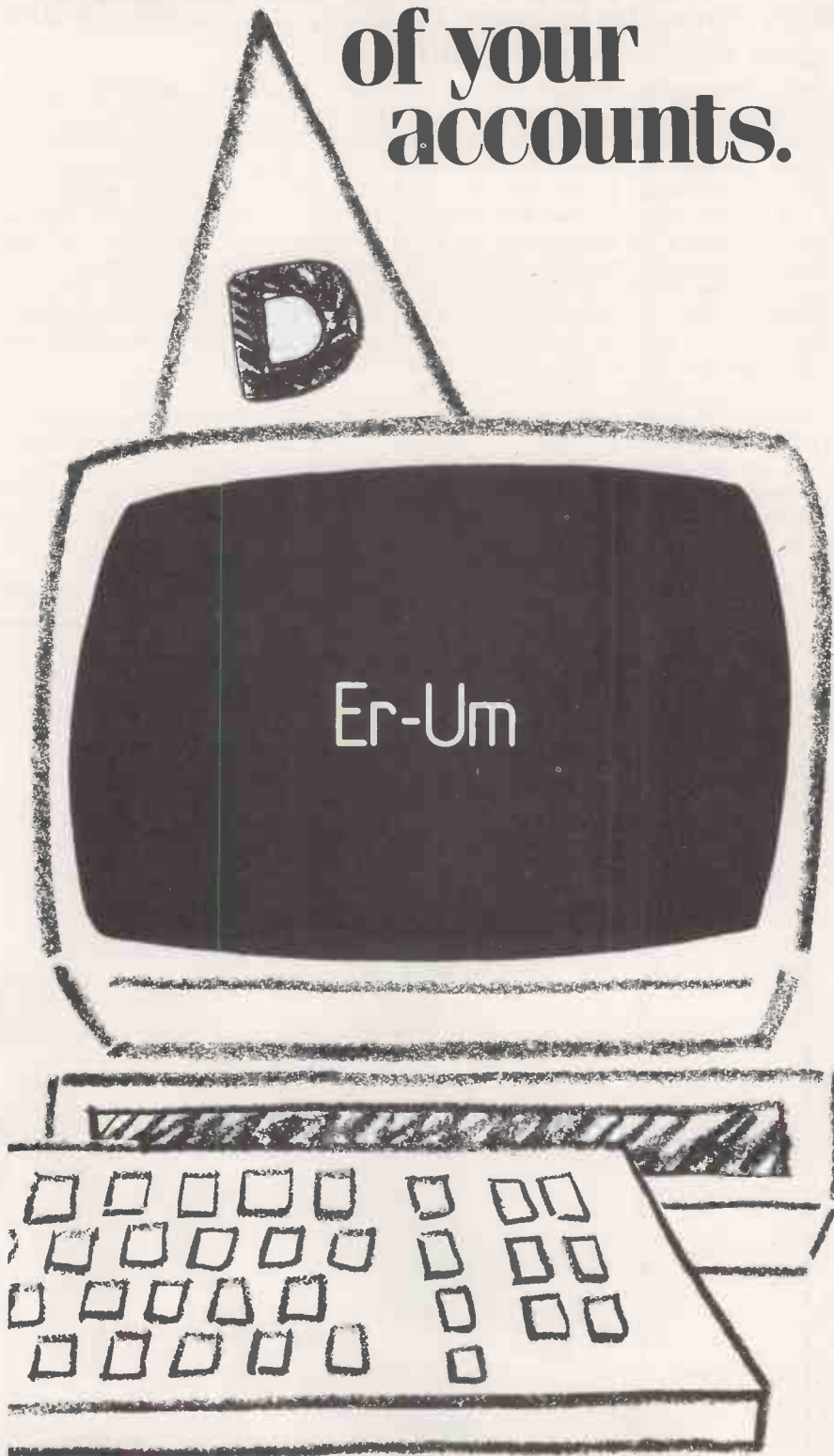

If your brand new, super-intelligent, electronic brain appears decidedly thick, it's probably not to blame. A computer is just a box of circuits. It's the program that makes it a box of tricks. Some programs are so inadequate they would make any computer look moronic. Others are far too complicated for the needs of the user and become uncontrollable monsters.

You'll be glad to know that Sage keep things simple, but effective. Our fully-integrated, one-diskette programs are easy-to-learn and use, yet cover every accounting function. From invoicing to final accounts, it's all there!

Sage is available on most CP/M, MS-DOS and PC-DOS computers and has so far been implemented on over 40 machines including Apple, Apricot, Epson, IBM-PC, Phillips, Sirius and Zenith. What's more you can choose the program to suit your needs from four great-value options.

- SAGE ACCOUNTS £375
- SAGE PLUS £525
- SAGE EXECUTIVE £695
- PAYROLL £195

Just return the coupon below and we'll make sure your computer doesn't end up standing in the corner.

**PC4**

Please send me your explanatory brochure.

Please arrange for me to have a demonstration.

I do not yet own a computer.  
I have a ..... computer.  
\*Delete as appropriate.

Name .....

Position .....

Company .....

Address .....

.....

Tel: .....

## SAGE

### Business Software

SAGESOFT LIMITED, NE1 HOUSE, REGENT CENTRE,  
NEWCASTLE UPON TYNE NE3 3DS.  
Telephone 091 284 7077 Telex 53623 SAGESI.G.

● Circle No. 152

# Backus- Moore notes

Christopher Roper describes a meeting between the computer scientists who gave you Fortran and Forth.

LAST OCTOBER an encounter took place between two legendary computer scientists who had never met each other before. One was John Backus, who wrote the first Fortran compiler almost 30 years ago; the other was Charles Moore, the inventor of Forth. Each had expressed an interest in meeting the other. Both are loners and stand outside the mainstream of programming development, critical from their different standpoints of the herd instincts of academics and manufacturers.

## Influential

After leading the Fortran team, Backus became briefly involved in the design of Algol, which was conceived in the late 1950s as a universal programming language, with the support of computer scientists from Europe and America. Algol is influential even today as the parent or grandparent of Pascal, Modula-2, Mesa, and Ada. Backus's main contribution was to provide a notation to describe the language, known as BNF.

Backus could have spent the next 10 years becoming a millionaire or ascending the IBM ladder. But he was bored with programming languages, and returned to his first love, which was pure mathematics. He was an IBM fellow, which meant that the company left him to his own devices for five years, then another five years.

Around 1970 he decided the problem he had been working on for years would lead nowhere. He dropped it, and returned to programming languages. Soon he decided that no one had done anything very interesting or new in his absence, and that the old languages were inadequate. "I've always been a lazy programmer, and I wanted something which would make programming easier", he told me.

Chuck Moore is probably 15 years younger than Backus. He graduated from MIT in 1960, where he admits to having been influenced by John McCarthy, the inventor of Lisp. He then became a programmer working in Fortran and Algol, the two dominant scientific programming languages at the time.

Unlike many language designers, he is first of all a programmer who went on to use the language he designed to write systems. Forth Inc., the company he set up

with Elizabeth Rather, does not just sell compilers for Poly Forth. It is an applications house which uses Forth to write a system for clients who then have Forth to extend and modify it as required.

Moore has now left Forth Inc. and has devoted most of his energies over the past three years into obtaining finance and corporate backing for the construction of a Forth machine; a computer which will sit on your desk and run Forth faster than existing RAM can handle it. He believes he can deliver speeds of 400 million instructions per second for around \$10,000. But he has failed to convince the industry and has had to go back to basics. He has designed his own CAD system and built a prototype with Forth's two stacks and all the Forth primitives integrated into the ECL board.

When Backus and Moore met, Backus

explained what he had been doing for the last 10 years. His underlying argument is that we make programming more difficult than it need be. All programs in his language are functions which can be applied to other programs to produce a third program. He wants to escape from the existing concept of program, which is basically "mapping one store into another. The transformation of a set of named cells into another set, with some cells having new contents."

According to Backus, the most fundamental problem is that programs depend on storage plans. "That means that knowing the action or purpose of a program is not enough to let me use it, unless I know its storage plan. That is, I must know the names of all its inputs and all of its outputs."

The basic object to be manipulated in



Chuck Moore: "Our concept of a program determines how we design machines."

Backus's functional programming language is not a number or a string, but a program, a function. The task he is currently engaged on is to establish his primitive functions from which all others may be built. Once he has established this primitive vocabulary, he will seek to optimise its interpretation/compilation because he does not believe people will use such a language unless it is efficient.

The ideas underlying his new language are quite esoteric, and most appreciated by mathematicians and logicians. But his purpose is one with which *Practical Computing* readers will identify: "There are millions of people who will want to use the flood of ever cheaper computers being produced. If they are to do so really effectively, they must be able to write programs themselves."

Backus and Moore agreed that most of the applications programs currently marketed are awful and on the difficulty of programming in most existing languages. Backus asserted: "If programming means what it means today, then it is out of the question to think of users writing their own programs."

Chuck Moore could not agree with this as he believes Forth already provides most of the answers. But often novices find Forth quite hostile until they start thinking

in Forth and while Moore recognises this problem, he feels it is one that other Forth programmers will have to solve. He thinks that a new hobbyists' robot, built by Androbot, will go some way to providing the kind of introduction to Forth which Logo provides for Lisp. He said Leo Brodie, author of *Starting Forth*, is already working on his next book, *Thinking Forth*.

For a man who has worked for the largest computer company on earth for the past 30 years, John Backus is refreshingly vague about commercial details. He admitted that his greatest problem concerns input and output. "My function world has some difficulty interacting with a real world of events and electronic devices."

This has, notoriously, been the problem with programming languages designed by mathematicians. One reason for Algol's relative lack of success was a total absence of provision for input and output. This was to be filled in later by the machine builders. As originally conceived, Lisp embodied some of the ideals of machine-independent functional programming but was unworkably slow and demanding in its pure form.

Chuck Moore is first of all a working programmer, and two languages designed by professional programmers, Forth and C, are currently spreading faster than any

others among microcomputer users. He, too, is vague about commercial details and has faced appalling problems in getting the Forth engine built. He was talking publicly about the design of such a computer more than three years ago, when *Byte* magazine devoted an entire issue to Forth.

His main aim is to have a Forth engine for himself. He wants to go back to interpreting data received by radio telescopes from outer space. He does not believe existing programming techniques give much chance of sorting the patterns which might indicate the presence of intelligent life elsewhere in the universe from the cacophony of jumbled signals now being received.

## Micro applications

It is, in fact, quite tough to think of applications for a personal computer which would be dramatically more powerful than today's machines. People faced the same problem trying to think of users for the first digital computers 35 years ago. Moore sees a number of scientific uses, and thinks his machine could dramatically reduce the cost of high-quality animation for feature films.

Both men see programming as the key to computer use, and do not believe that personal computing will realise its potential unless people learn to program. They were in closer agreement as to what the programming language of the future should look like than I had expected. It will be extensible, fast, compact and comprehensible. They both believe that the new programming languages will determine the design of future machines. Moore is already putting his ideas into practice, while Backus said: "Let's be clear about it. It is our basic concept of what a program is that determines both how we program and how we design machines."

Equally, they agreed that the impetus for new programming languages will come from the ever wider distribution of personal computers. The problem is that the manufacturers are reluctant to build new machines until there is a demand for them. While the buyers of computers cannot demand radical new designs until they are built.

Luckily, Backus and Moore, and hundreds of others like them, are still working on radically new ideas, and demonstrating that these do not necessarily depend on the resources of a multi-nation corporation. Backus is still quick to recognise his debt to IBM since the company has had the foresight to leave him essentially to do his own thing for 30 years.

Talking to them reinforced my sense that the microcomputer revolution is only just beginning. The most powerful developments are coming from closer associations between hardware and software designers. There is a growing realisation that not only do they have to work together closely, but they also have to take account of the needs of people buying computers.



John Backus: Interacting with a real world of events and devices.



# PRICES SLASHED!

## APPLE IIe

Apple IIe 64K	£450
D/Drive W/Controller	£240
D/Drive without	£190
80 Col. Card	70
80 Col+ 64K	£180
Apple 12" Monitor	£125
Phoenix 12" Monitor	£90

## Macintosh™



Interest Free  
Credit available

WITH FREE MACWRITE  
& MACPAINT  
£1795

## Lisa 2

CHEAPER & FASTER

Lisa 2  
with Macintosh  
operating system £2625

Lisa 2/5  
with 5Mb Hard Disk £3375

Lisa 2/10  
with 10Mb Hard Disk £4135

Superb Graphics  
and Integrated Software



AND FOR WORK FOR HOME FOR EVERYWHERE IN BETWEEN

## THE APPLE IIc



- 128K RAM as standard
- Built in 5¼" disk drive
- 40 and 80 columns
- Transportable — weighs 7lbs.
- 2 Serial Ports
- Takes Mouse, Joystick, Paddles
- Library of 10000 programs
- 12" long 11¼" wide 2¼" high

THE TOTAL SOLUTION IN ONE BOX

ONLY £869

For computerised solutions to business problems contact

# SIMMONS MAGEE COMPUTERS LTD

13 YORK STREET, TWICKENHAM, MIDDLESEX TW1 3JZ

## 01-891-4477

ALL PRICES EXCLUSIVE OF V.A.T.



# EPSON PX-8 PERSONAL PORTABLE COMPUTER



## PERSONAL COMPUTER POWER – WHEN AND WHERE YOU WANT IT

- Total compatibility with the wide range of Epson products.
- Total support from Transam with both software & technical expertise.
- Big 80\*8 LCD virtual screen with full graphics.
- 64K User Ram expandable to 184K, Ram disk area.
- Built in microcassette drive for mass storage.
- CP/M operating system and Basic in ROM – wide range of compatible software.
- Wordstar, Micro Calc, Scheduler, & Cardbox Plus supplied as standard in plug-in ROMs, Terminal & Comms software also included.
- Dual NiCd batteries for non-stop computing, (AC charger supplied).
- Three microprocessors for speed & power, inc. industry std. Z80.
- RS232 and serial communication ports.

Epson PX-8 64K Computer with all SW detailed above. £798.00 + VAT

Epson PX-8 64K Computer as above, with 120K RAM Pack. \*£998.00 + VAT

Epson TF-20 dual 5" drive unit (mains, inc IF cable) £525.00 + VAT

★ RAM Pack available June/July

To reserve your machine telephone our sales hot-line on 01-404 4554 immediately.

Additional Software available from Transam, either on disk or cassette. Please specify which version is required when ordering.

- Lisp80 (SW Toolworks) £ 60.00 + VAT
- TCL Pascal Compiler £ 60.00 + VAT
- C-80 (SW Toolworks) £ 60.00 + VAT
- Nevada Fortran £ 70.00 + VAT
- Indexer £100.00 + VAT
- Superfile/Superforms £195.00 + VAT
- BSTAM Communications £135.00 + VAT
- Blast (PX8 TO IBMPC COMS) £195.00 + VAT
- HX20 DevPack (XASM68) £150.00 + VAT
- Big 80\*8 LCD visual screen with full graphics.

DEALER PRICES AVAILABLE ON SOFTWARE.



## Transam

MICROSYSTEMS LIMITED

59/61 Theobalds Road,  
LONDON WC1X 8SF

Tel: 01-404 4554



■ THE TECHNOLOGY YOU WANT ► THE ADVICE YOU NEED ■

The BBC Micro's function keys can do much more than merely save typing, as John Dallman explains.

# Keys to

THE MOST FAMILIAR application of the BBC Micro's function keys is to provide a string of characters when the key is pressed, just as if the characters had been typed in from the keyboard. These character strings are set up using the \*Key command. Like the rest of the function key system this command is part of the operating system and totally independent of Basic.

Character strings to be implemented by the function keys are stored in a buffer in the area of RAM reserved for the operating system at locations &B00 to &BFF. Information on which characters in the buffer belong to which key is also held here, and occupies 17 bytes, leaving 239 free to hold characters.

One application for the function keys that is not as widespread as it should be is holding the character strings used for programming intelligent printers. Most dot-matrix printers can use several printing modes, which are set up by control characters. These characters can be put into a key's defining string using the | symbol, so

```
*KEY 4 |A| |A|@
```

will set up key 4 to send the codes 27, equivalent to |, and 64, equivalent to |@, to any currently selected printer, and to that printer only. The |A, equivalent to VDU1, is used to prevent the codes going to the VDU drivers. The sequence, as any Epson user should recognise, is the Esc @ which resets any Epson MX, FX or RX printer.

The BBC Micro *User Guide* leaves out some vital information on this subject. On page 141 it shows the use of quotes to enclose a string being placed on key 3, but does not state when they are mandatory as opposed to permissible. A key-defining string should only be in quotes when leading spaces are to be significant. If a string is not in quotes, all characters between the key number and the first non-space character of the string will be ignored by the operating system.

Two errors which may occur when using the function keys can be trapped and manipulated by Basic's On Error mechanism like any of Basic's own error messages. The message Bad Key is generated when an attempt is made to define a nonexistent key or when a normal key is defined with a string that is too long to fit in the free space in the function-key buffer; its Err value is 251. The message Key in Use, with an Err of 250, happens when an attempt is made to alter the definition of a function key while its current contents are still being read out. For an example of how this one works type in the one-line program

```
10 *KEY4 RUN|M LIST|M
```

## Program 1.

```
10 REM Program 1
20
30 REM Prints out in Hex the contents of a page of memory.
40 REM Currently fixed to display function-key buffer.
50
60 REM Program by J.G.Dallman, September 1983
70
80 MODE3
90 @% = 4 :REM Set print field width
100
110 REM INPUT ' ENTER BASE ADDRESS (HEX) 'BASE$
120 REM BASE$ = "&"+BASE$
130 REM BASE% = EVAL(BASE$)
140
150 REM Un-REM the three lines above and take out the next-but-two
160 REM to make a general purpose memory display program out of this.
170
180 BASE% = &B00 :REM Remove for general-purpose version
190
200 PROCnumbers
210
220 LIMIT% = BASE% + &F8
230
240 FOR X%=BASE% TO LIMIT% STEP &10
250 PRINT " X%" " ";
260 FOR Y%=0 TO &F
270 ADDR% = X% + Y%
280 PRINT "?ADDR%";
290 NEXT
300 PRINT " " "X%
310 NEXT
320
330 PROCnumbers
340
350 END
360
370
380 DEF PROCnumbers
390 LOCAL Y%
400 PRINT " " " ";
410 FOR Y%=0 TO &F:PRINT "Y%";:NEXT
420 PRINT
430 ENDPROC
```

## Program 2.

```
10REM Machine code compilation program for function keys article.
20REM Contains the following routines:
30REM
40REM SWAP - exchanges contents of pages &A and &B to
50REM swap the two sets of function keys
60REM
70REM LISKEYS - lists the definitions of all function
80REM keys currently defined within the
90REM current page of key definitions
100REM
110REM FANCYSTART - uses the other routines to display
120REM all function key definitions - intended
130REM for use with a disc system to display
140REM the key definitions when they are load-
150REM by %key_definitions_filename (as a %RUN)
160REM
170REM Program by J.G.Dallman, (C) August 1983
180REM
190
200OSBYTE = &FFF4
210OSWRCH = &FFEE
220OSNEWL = &FFE7
230
240FOR PASS%=0 TO 3 STEP 3
250
260P%=&900 :REM Code compiles into RS423 transmit buffer.
270[
280
290OPT PASS%
300
310.SWAP \ Code to swap two pages of function keys
320
330LDA#244 \ We must set the softkey consistency flag
340LDX#255 \ ie false
350LDY#0 \ padding value..
360JSR OSBYTE \ And make the MOS call.
```

# improvement

```

370
380LDY #0
390.SWLP
400LDA &A00,Y
410TXA
420LDA &B00,Y
430STA &A00,Y
440TXA
450STA &B00,Y
460INY
470BNE SWLP
480
490LDA#244
500LDX#0
510LDY#0
520JSR OSBYTE
530
540RTS
550
560
570
580
590
600
610
620.KSTR
630
640]
650#P% = "KEY "
660P%=P%+4
670[
680OPT PASSX
690.KSTART
700BRK
710.KEND
720BRK
730
740
750.LISKEYS
760
770LDX #0
780.KLOOP
790JSR KINDEX
800JSR OUTKEY
810JSR OSNEWL
820INX
830CPX #16
840BNE KLOOP
850RTS
860
870
880.KINDEX
890LDY #0
900.KSTRINGLOOP
910LDA KSTR,Y
920JSR OSWRCH
930INY
940CPY #4
950BNE KSTRINGLOOP
960TXA
970CMP #10
980BCC KONESD
990LDA #ASC("I")
1000JSR OSWRCH
1010TXA
1020SEC
1030SBC #10
1040JMP KLSDDOUT
1050
1060.KONESD
1070LDA #32
1080JSR OSWRCH
1090TXA
1100.KLSDDOUT
1110CLC
1120ADC #48
1130JSR OSWRCH
1140LDA #ASC(" ")
1150JSR OSWRCH
1160RTS
1170
1180
1190
1200.OUTKEY
1210
1220TXA
1230TAY

```

\ Initialise count - we move 256 bytes  
\ Start of swapping loop  
\ Get a byte from page &A...  
\ hide it...  
\ get it's replacement from page &B  
\ and store that where that hidden one was  
\ Recover hidden byte  
\ and store it in the current keys page  
\ Increment count  
\ Go back for another if we haven't finished  
  
\ Now reset the consistency flag  
\ True value  
\ padding..  
\ and to the MDS..  
  
\ all done here, boss...  
  
\ Variables area for key-displaying program.  
  
\ Label the string that we poke in from BASIC.  
  
:REM use EQU\$ and EQU\$ if you've got BASIC II.  
  
\ Store for pointer to start of key definition.  
  
\ Store for pointer to end of key definition.  
  
\ Main program for displaying key definitions.  
  
\ Initialise count  
\ Main loop  
\ Output "KEY xx"  
\ Print out key definition  
\ Newline  
\ Increment count (X preserved by routines)  
\ Finished?  
\ Go back if more keys to be output  
\ Now back to BASIC.  
  
\ Routine to output "KEY n" - n in X reg.  
\ Guess what? initialise another count!!  
\ Loop prints out "KEY "...  
\ get character...  
\ print... boring, eh?  
\ Increment loop counter  
\ Short string this...  
\ go and get some more of it  
\ What number must we output?  
\ ie;- more than one digit?  
\ Branch if only one digit  
\ Output this 'ere "I"  
\ with this...  
\ Get the number back...  
\ (don't chip builders do weird things?)  
\ and get it into a form for output...  
\ and then go and do that  
  
\ Deal with One Significant Digit output.  
\ Output a space  
\ ..so..  
\ and get the number we're to output.  
\ Least Significant Digit Output  
\ (see above note on chip design..)  
\ Convert to an ASCII number...  
\ and output it...  
\ put a space after it...  
\ and output that.  
\ We've finished icing the cake, and now....  
  
\ will output the definition of the key who's  
\ number is in the X register.  
\ Get a working copy of the key number...  
\ into Y

(listing continued on next page)

then run it and press f4. The program is attempting to redefine key 4 while the first action, the Run, is still being carried out.

To do much more than this with the function keys you have to understand how the function-key buffer is managed by the operating system. Type in program 1 and use it to examine the buffer while defining and redefining a few keys.

The first 17 bytes of the buffer hold pointers to the strings held within it. Locations &B00 to &B0F hold offsets from &B00 to the position in the buffer one byte before the start of the strings belonging to keys 0 to 15. Location &B10 holds the offset to the position in the buffer one byte before the start of free space.

The information in this article is for a machine with OS 1.2, although most of it should also apply to OS 1.0. In OS 0.1 the buffer is arranged in a slightly different manner, and many of the \*FX and Osbyte calls described here will not work.

## Zero length

If you play around with program 1 you will find that in the buffer's empty state — use \*FX18 to clear it — where it is filled with &10 in all locations, all the keys are in effect defined with strings of length zero, as are all unassigned keys at any time. Also, control characters stored with | or !| are stored as one character, saving buffer space.

Defining a new key or deleting a definition requires a fair amount of shuffling of the buffer. The operating system maintains a flag to tell it if the buffer is in a consistent state with the pointers in &B00 to &B10 describing the arrangements of the strings in the buffer correctly. This is necessary as interrupts occur frequently and from many sources, including the keyboard.

If the flag indicates that the buffer is in an inconsistent state during a soft break — implemented by Break or Shift-Break — then the function-key buffer is cleared. The flag is accessed through Osbyte &F4, equivalent to 244, and works like those calls described on page 438 of the *User Guide*. If the flag is set to zero the buffer is consistent; any other value indicates that it is in a mess. The Swap routine in program 2 gives some examples.

When a function key is pressed, an ASCII code equal to 128 plus the key's number is put into the normal keyboard buffer: 128 for key f0, 129 for f1 and so on. When that character reaches the end of the buffer and is read by Basic, using the Osrdch call — see page 456 of the

(continued on next page)

(continued from previous page)

User Guide — Osrdch performs some interpretation.

By default characters 128 to 138 are used to trigger the reading out of the appropriate function-key definition, while characters 139 to 143 are used as control codes to drive the line editor; the arrow and Copy keys generate them. The operating system command \*FX4, 2 allows these keys also to be interpreted as function keys. The character codes placed in the buffer by various uses of the function key are shown in table 1.

The same codes should be used with \*FX138,0,y to call up the effects of these keys — see page 433 of the User Guide for information on \*FX138. The interpretation of these codes is set by four \*FX or Osbyte calls, numbers 225 to 228; they are described on pages 439 to 440 of the User Guide.

The User Guide fails to mention that any or all of the four groups can be set to be expanded as strings by setting their base numbers to 1. In this way you could make the Shift-Ctrl function keys yield strings if you wanted to. This could be very useful in Acornsoft's View word processor, for example, which does not normally allow function keys to be used for holding strings, a feature which is at its most useful in a word processor.

The \*FX and Osbyte calls numbered 221 to 224 also control the interpretation of input codes, this time of codes 192 to 255, &C0 to &FF. They cannot be input from the keyboard but may arrive from the RS-423 serial interface or a user-provided keyboard. The codes are divided into groups of 16 codes. Each group has a base number set for them by these four calls which is treated just like the base numbers set up by \*FX225 to 228.

The User Guide states that \*FX224 cancels the VDU queue. This function is, in fact, performed by \*FX or Osbyte 218, which can be used in the same manner as the calls described on page 438 of the User Guide to read or write the number of bytes required for the execution of the VDU statement pending. The number is stored as the negative of the number of bytes still required. Writing zero to this status location abandons the VDU command currently in progress, which can conveniently be done by a simple \*FX218.

To find out more about the interpretation of input codes by Osrdch, use Osbyte 152, which reads from a buffer whose number is in the X register of the 6502 on entry to the subroutine. When the

Key	dec	hex
Function keys alone	128-143	&80-8F
Shifted function keys	144-159	&90-9F
Ctrl plus function keys	160-175	&A0-AF
Shift-Ctrl plus function keys	176-191	&B0-BF

Table 1. Codes generated by function keys.

(listing continued from previous page)

```

1240LDA &B00,Y          \ Get pointer to the start of the definition..
1250                    \ of key Y (1 byte before that in fact)
1260CMP &B10            \ Is it free space (key not defined)?
1270BEQ KABORT         \ if so, we can finish now
1280STA KSTART         \ else, store it, it's needed
1290LDY &255          \ This is clever... but not a lot...
1300STY KEND           \ store a temporary value, to do tests against
1310
1320.KSEARCH           \ Search for end of the key def. with pointers
1330JNY                \ It's a counter, as well!!!!
1340CPY &17            \ Got to the end yet?
1350BEQ PRNT          \ if so, go and output the string
1360LDA &B00,Y        \ Get the Y'th pointer...
1370CMP KEND
1380BCS KSEARCH        \ Is it > the current KEND value?
1390CMP KSTART
1400BEQ KSEARCH
1410BCC KSEARCH
1420STA KEND
1430
1440 JMP KSEARCH      \ OR (<= KSTART?
1450
1460.PRNT             \ If not, it's a new approximation to the end..
1470LDY KSTART       \ of the string defining key X.
1480.PRNTLOOP        \ Now go and look for a better one
1490JNY
1500LDA &B00,Y        \ point to next character...
1510BPL CTRLCHAR     \ get that character...
1520PHA              \ If less than 128, check next possible problem
1530LDA &ASC("!" )   \ it's > 128, so output !! first..
1540JSR OSWRCH       \ I think you can understand this...
1550LDA &ASC("!" )   \ as we output the "!"
1560JSR OSWRCH       \ and the "!"
1570PLA              \ like so...
1580SEC              \ Get back, and prepare..
1590SBC &128         \ the long way...
1510.CTRLCHAR        \ to make it printable.
1511CMP &32
1520BCS PRNTABLE     \ Branch if it's printable
1530PHA              \ Else, hide the character - only place free
1540LDA &ASC("!" )   \ Indicate the control character...
1550JSR OSWRCH       \ on the screen
1560PLA              \ Get the character back...
1570CLC              \ (well.. the chip seems to work.....)
1580ADC &64          \ convert to CTRL-X form..
1590.PRNTABLE        \ it's printable now!
1600JSR OSWRCH       \ We've done enough work - let the MOS do it
1610CPY KEND         \ End of the string?
1620BNE PRNTLOOP    \ If not, go and do some more
1630
1640.KABORT          \ Need I comment?
1650RTS
1660
1670
1680.FANCYSTART
1690
1700
1710LDA &14
1720JSR OSWRCH
1730JSR OSNEWL
1740JSR SWAP
1750JSR LISKEYS
1760JSR SWAP
1770JSR OSNEWL
1780JSR LISKEYS
1790LDA &15
1800JSR OSWRCH
1810RTS
1820
1830
1840J
1850NEXT

```

### Program 3.

```

10REM Program 3 - an interactive key-setting program
20REM by J.G.Dallman, August-September 1983
30MODE3:XTV0,1
40DIM KDE$(30),KY$(30),buffer% 239
50VDU23,255,&1800;&1818;&3C7E;&18;23,254,&1800;&7E3C;&1818;&18;19,0,7,0;0,19,
1,0;0;
60PROCinstructions:PROCclear:B$="0.:M":swapped=FALSE:PROCsetkey("",10)
70ON ERROR GOTO 90
80FOR I%=0 TO 99:READ KDE$(I%),KY$(I%):NEXT:GOTO 110
90IF NOT(ERR=42 OR ERR=15) THEN REPORT:PRINT" AT LINE "ERL:END
100IF ERR=15 CLS:VDU7,7:REPORT:PRINT" at line ";ERL:PRINT"" No room for all av
ailable options - please re-dimension KDE$( ) and KY$( )":END
110ON ERROR GOTO 290
120IF !&926 (<) &2059454B THEN PRINT"" The machine code routines required by th
is program are not in place - please"" load them":VDU 7:END
130usable_keys=I%-1:PROCpause
140CLS:PRINTTAB(20,1)"Key options are:"":FOR I%=0 TO 18:PRINT I%" "KDE$(I%):NEX
T
150bottom=18:VDU 28,0,24,79,23
160REPEAT :REM ***** Program main loop
170pt%:=FNpick
180*FX15,1

```

```

190IF Opt%>0 THEN CLS:PRINT "KDE$(Opt%);:PRINT SPC(78-LEN(KDE$(Opt%))) ELSE PR
OCsave:END
200IF KDE$(Opt%)="Input key-setting string from user" THEN INPUTLINE" Your stri
ng is ? "KY$(Opt%)
210Key%=FNkey
220swapping=(KDE$(Opt%)="Swap current keys with alternates and set up a key to
do this"):IF swapping THEN PROCswap
230IF swapping AND swapped THEN CLS:PRINT" You already have a set of alternate
keys. These are now in position, and you""can overwrite them if you want to";
:PROCpause:CLS
240IF swapping THEN swapped=TRUE
250PROCsetkey(KY$(Opt%),Key%)
260UNTIL FALSE :REM XXXXXXXXXXXX Only exit is by error, Escape or option 0
270REMXXXXXXXXXXXXXXXXXX Error Handling XXXXXXXXXXXXXXXXXXXX
280IF ERR=251 THEN PRINT" Sorry - no room for that key definition. If you ha
ven't already got a set of"" 'alternate' keys, then that's your best bet here.
";:PROCpause:GOTO160
290IF ERR<17 THEN REPORT:PRINT" at line "ERL;ELSE VDU26,12:PRINT"" Function
keys set up..Byeeee.."::AFX4
300END
310REMXXXXXXXXXXXXXXXXXXXXXXXXXXXXXXXXXXXXXXXXXXXXXXXXXXXXXXXXXXXXXXXXXXXXX
320
330DEF PROCsave
340VDU26,12
350PRINT"" The key definitions will now be saved as a memory copy"" To relo
ad them, please type XKEYS, which will list the key definitions as"" they load
in, or XLOAD "KEYS", which will simply load them.""
360PRINT" Please position the disc"::PROCpause
370XSAVE "KEYS" 0900 0BFF 09CB
380PRINT"" The program will now list the key definitions on the printer.""
If you don't want the list, please hit ESCAPE "::PROCpause
390REM next line must open printer
400AFX5,0
410CALL &9CB
420REM Next line must close printer
430AFX5,1
440ENDPROC
450
460DEF PROCclear:FORI%=&A00 TO &BFF:?!%=&10:NEXT:ENDPROC
470
480DEF PROCsetkey(def%,k%)
490ON ERROR GOTO 280
500IF k%>10 THEN def%=&+def%
510PROCoscli("KEY"+STR$(k%)+def%)
520ENDPROC
530
540DEF PROCoscli(keydef%)
550%buffer%=&keydef%
560X%=&buffer% MOD 256:Y%=&buffer% DIV 256
570CALL &FFF7
580ENDPROC
590
600DEF PROCswap:PROCsetkey(KY$(Opt%),Key%):CALL &900:CLS:PRINT" That key will
swap the two sets of function keys, in both sets. If you change"" it, you'll l
oose access to the alternate set.":IF NOT swapped THEN PROCsetkey("",10)
610PROCpause:CLS:ENDPROC
620
630DEF PROCpause:PRINT" (SPACE to continue)":REPEAT:UNTIL INKEY(-99):AFX15,1
640FORI%>1 TO 20:VDU127:NEXT:ENDPROC
650
660DEF PROCinstructions
670PRINTTAB(20,1)*5Key Version 1.0 (Program 3)
680PRINT"" This program is intended for building sets of function-key defin
itions,"" which may be saved as a memory area and hence loaded without affectin
g any of"
690PRINT" the other contents of the computer's memory."
700PRINT"" This version is intended only for use on BBC machines with OS 1.
0 or later"" and is usable with all filing systems, although mainly intended f
or use with"" disc-based systems."
710PRINT"" For a full description of the facilities of this program, please
refer to"" the accompanying article."
720PRINT"" To use it to build a set of key definitions, enter the number of
the desir-"" ed key definition from the menu (use the editing ";:VDU255,44,254
:PRINT" keys to scroll the menu)"
730PRINT" and then press the function key on which the definition should be pl
aced."
740 PRINT"" Menu options 0, 1, 2 and 11 will have an effect immediately: th
e described"" function will be performed at once, rather than defining a key to
do it."
750ENDPROC
760
770DEF FNpick
780AFX4,1
790in%=STRING$(20,"?")
800REPEAT
810in%=""
820CLS:PRINT"" Please enter an option number (Editing ";:VDU255,44,254:PRINT"
to scroll) & RETURN ";
830REPEAT
840in%=GET
850IF INKEY(-58) OR INKEY(-42) THEN PROCscroll
860IF in%>47 AND in%<58 THEN in%=in%+CHR$(in%):VDU in%
870IF in%>127 AND LEN(in%)>0 THEN in%=LEFT$(in%,LEN(in%)-1):VDU in%
880UNTIL in%>13 AND LEN(in%)>0
890UNTIL ((VAL(in%))=0) AND (VAL(in%)<=usable_keys))
900AFX4,0
910=VAL(in%)
920
930DEF FNkey
940AFX4,1

```

(listing continued on next page)

call returns, the buffer was empty if the C flag of the 6502 is set.

Otherwise there are characters available in the buffer, and the next one that would be obtained by Osrch can be inspected. It is accessed by

LDA (&FA),Y

using the value of Y returned by Osbyte 152. This does not remove the character from the buffer, but copies it into the accumulator. More information on this call can be found in the *BBC Micro Advanced User Guide*, produced by the Cambridge Microcomputer Centre and written by Andrew Bray, Adrian Dickens and Mark Holmes.

The BBC's function keys can provide a batch mode of operation like that normally available through \*Exec from a disc file to the cassette user. The BBC Micro normally appears to ignore anything typed on the keyboard while it is loading or saving to the cassette system. Characters are received and buffered, but are then thrown away by Osrch. Codes that are to be expanded as function-key strings are kept, however, and expanded and acted on when the filing-system access is over. This is very useful for automatically saving multiple copies of a file.

## No more space

The first problem you are likely to encounter with the function keys is simply running out of keys or of buffer space. All the key definitions and their associated information are held in one small area of memory, but it should be possible to keep another set somewhere else in memory and exchange them as required. This leads to the concept of the current key, which is immediately available, and the alternate function keys.

Any area of memory you choose to hold function-key information should be outside Basic's areas at the very least, and should otherwise interfere with the system as little as possible. I sited the alternate set of key definitions in the RS-423 input buffer, memory locations &A00 to &AFF, and the swapping routine and other machine-code routines in the RS-423 output buffer, &900 to 9FF. This still removes the RS-423, cassette data files, envelopes 5 to 16 and the speech-synthesis buffer, but it is the only place from which to steal 512 bytes without rendering the machine unusable.

The Swap routine is provided as the first part of program 2, which also describes its detailed operation. The two sets of key definitions are exchanged by Call &900. As the three pages of memory involved form a single area of the BBC's memory map, they can be saved together with \*Save, and reloaded with \*Load without affecting Basic programs in memory at the time.

The Liskeys routine contained in program 2 lists the current contents of the function-key buffer on the screen when

(continued on next page)

(continued from previous page)

Called at &92C. As it has to allow for the possibility of the function keys having been defined in any order, it is necessary to search through the pointers in &B00 to &B10 to find the end of each key definition. Control characters are displayed in the form in which they were entered into the buffers using or ! operators.

The Swap routine can be combined with Liskeys to examine the contents of the alternate keys buffer. The Fancystart routine does exactly this, using Swap and Liskeys as subroutines. It displays the alternate key definitions first, followed by the current keys, leaving the same set in the function-key buffer as was there before it was called. It is most useful on a disc-based system, where two sets of key definitions and the machine-code routines can be saved as one file, with an entry address specified of &9C8, the start of Fancystart.

If such a file is \*Run or called as a command with

```
* <filename >
```

the two sets of key definitions will be loaded and displayed. The display is done in page mode, rather than scroll mode, as the output is far too fast to read otherwise. If you only need one set of key definitions use Liskeys instead of Fancystart as the entry address for the file of key definitions. This would also allow the RS-423 to be used, although only in one direction.

Program 3 allows two sets of key definitions to be constructed and saved using the machine-code routines of program 2. It assumes that the routines are at a specified position, at which they are placed by program 2, and this is checked for by looking for the string Key provided for Liskeys. If they are not there the program asks you to load them. If they are stored as a memory copy this can be done without having to reload program 3 afterwards.

After a page of reminder instructions the program presents a menu of possible key definitions and some other actions. The menu scrolls to display all of the available options by using the editing keys. More options can be added in Data statements at the end of the program in the same format as those already there.

To define a key with one of the available options, enter that option's number from the menu and then press the function key on which you want to place it. The editing keys can be defined, but they will remain in their usual mode until explicitly enabled by \*FX4,2. The general structure of the program is clear from the listing, and a list of variables and procedures is provided in table 2.

To exit from the program, saving both possible sets of function keys and the machine-code routines from program 2 as a file named Keys, select option 0 from the menu. The saving process begins immediately. If you include the appropriate \*FX and VDU calls at the places noted in Procsave, it will also print a list of all the

(listing continued from previous page)

```
950PRINT " Please push the function key this should be placed on ('B' for
Break )";
960BUT=-1
970REPEAT
980IF INKEY(-33) BUT=0
990IF INKEY(-114) BUT=1
1000IF INKEY(-115) BUT=2
1010IF INKEY(-116) BUT=3
1020IF INKEY(-21) BUT=4
1030IF INKEY(-117) BUT=5
1040IF INKEY(-118) BUT=6
1050IF INKEY(-23) BUT=7
1060IF INKEY(-119) BUT=8
1070IF INKEY(-120) BUT=9
1080IF INKEY(-101) BUT=10
1090IF INKEY(-106) BUT=11
1100IF INKEY(-26) BUT=12
1110IF INKEY(-112) BUT=13
1120IF INKEY(-42) BUT=14
1130IF INKEY(-58) BUT=15
1140*FX15,1
1150UNTIL BUT> -1
1160*FX4,0
1170REPEAT:UNTILINKEY(-129):REM Until NO Keys depreed
1180*FX15,1
1190=BUT
1200
1210DEF PROCscroll
1220VDU23,0,10,106,0;0;0;28,0,21,79,3,31,0,18
1230REPEAT
1240REPEAT:UNTIL NOT(INKEY(-58) AND INKEY(-42))
1250 IF INKEY(-58) THEN next_key=FNup:PRINT next_key "KDE$(next_key);
1260 IF INKEY(-42) THEN next_key=FNdown:PRINT next_key "KDE$(next_key);
1270UNTIL NOT(INKEY(-58) OR INKEY(-42))
1280VDU28,0,24,79,23,31,(64+LEN(in$)),1,23,0,10,103,0;0;0;
1290*FX15,1
1300ENDPROC
1310
1320DEF FNup:VDU31,0,18,10:bottom=bottom+1:IF bottom>usable_keys THEN
bottom=0
1330=bottom
1340
1350DEF FNdown:VDU30,11:IF bottom=0 THEN bottom=usable_keys ELSE bottom=
bottom-1
1360IF bottom<18 THEN =bottom-17+usable_keys ELSE =bottom-18
1370
1371REM ***** End of program
1372
1380REM DATA has format: Descriptive string, string to be placed in key.
1390
1400DATA"Save keys and exit program (Escape gets out without saving)",""
1410DATA"Empty a key",""
1420DATA"Swap current keys with alternates and set up a key to do this",
"CA.&900:M"
1430DATA"List current set of keys","CA.&92C:M"
1440DATA"List alternate and current sets of keys","CA.&9C8:M"
1450DATA"Decimal output calculator","INPUT'Z$:P.EVAL(Z$):M"
1460DATA"Hex output calculator","INPUT'Z$:P.EVAL(Z$):M"
1470DATA"Mode 3, paged listing","MO.3I:INL:M"
1480DATA"Mode 7, paged listing","MO.7I:INL:M"
1490DATA"Restore normal VDU and keyboard settings and flush all buffers",
":CIF:2:T:0:DXFX12:MXFX4:MXFX15:M"
1500DATA"Print (hex) remaining space for program","DIM P%-1:P."H.-P%:M"
1510DATA"Input key-setting string from user",""
1520DATA"Increment PAGE by 2k & display it (hex)","PA.=PA.+2848:P."PA.:M"
1530DATA"Decrement PAGE by 2k & display it (hex)","PA.=PA.-2848:P."PA.:M"
1540DATA"Turn editing keys into softkeys","*FX4,2I:M"
1550DATA"Restore edit keys","*FX4I:M"
1560DATA"Open parallel printer","*FX5,1:MXFX6:M:B"
1570DATA"Reset Epson MX-80 III/FX-80","!A:!!A@"
1580DATA"Set MX-80/FX-80 to 'nice' printing","!A:!!A!!!A@"
1590DATA"Select U.S. characters on MX-80/FX-80","!A:!!A!A!A@"
1600DATA"Select U.K. characters on MX-80/FX-80","!A:!!A!A!A!C"
1610DATA"Set FX-80 to Elite","!A:!!A!A!M"
1620DATA"Set FX-80 to proportional spacing","!A:!!A!A!A!M"
1630DATA"Set FX-80 to quiet printing","!A:!!A!A!A!M"
```

key definitions on your printer. The program uses \*FX5,0 to enable it to dump the printer output.

The file Keys has its entry address set to that of Fancystart and will perform as described under Fancystart when the commands \*Run "Keys" or \*Keys are used. If you only need one set of key definitions, change the entry address to that of Liskeys.

Option 1 also acts immediately, clearing the selected key. When a new definition of a key is being set up the system checks for space without subtracting the space used by the old definition string. The Bad Key error may be generated unnecessarily if you

redefine a key without using option 1 first.

Selecting option 2 swaps the current key definitions with the alternate set by calling Swap at &900. The selected key is defined with Call &900 in both sets of definitions. If the swap is being done for the first time, the Break key is also set up as Old M. If more than one swap has been done, the program will warn that you could overwrite the definitions in the set just swapped in.

Option 11 prompts for the input of a string, which will be placed on a key selected subsequently. As this is input with Basic's Input Line command it can contain any character which can normally be generated from the keyboard. M

# SOFTWARE CENTRE

CP/M

CP/M-86

MSDOS

## MICROPRO SOFTWARE SYSTEM

PLANSTAR: Advanced financial planning.....£295  
**WORDSTAR**: Best selling professional Word Processing software; On screen formatting, Block manipulation, File read/write, Simultaneous Editing and Printing .....£299  
**MAILMERGE**: Enhancement for document personalisation and mailing applications .....£145  
**SPELLSTAR**: Enhancement for checking spelling and maintaining spelling dictionaries.....£145  
**STARINDEX**: Useful package for creation of Table of Contents, Index, List of Figures, Interfaces to Wordstar to improve document presentation quickly and easily.....£116  
**INFOSTAR**: Impressive Data Base system combining the power of Datastar with the flexibility of Reportstar .....£295  
**DATASTAR**: Screen based Data Entry, vetting and retrieval system. Screen formats under user control.....£175  
**REPORTSTAR**: Powerful report generator, provides much needed enhancement to Datastar for report production and transaction processing.....£210  
**CALCSTAR**: Electronic spreadsheet with interfaces to all MicroPro products.....£116

NB: Combination prices — WS/MM  
 £390; WS/MM/SP/SI £495

## DATABASE MANAGEMENT

**FORMULA II**: Unique information management system with exceptional capabilities for Application Generation. Multiple files and indexes, transaction processing, interactive, no programming language required.....£450  
**dBASE II**: The most popular of data management systems. very powerful application generator.....£437  
**QUICKCODE**: Add-on facility for dBASE programmers to speed development process by generating dBASE command files.....£200  
**dGRAPH**: Extremely useful program for graphical representation of dBASE and user created data files.....£200  
**dUTIL**: Utility to speed up dBASE execution.....£69  
**CARDBOX**: Highly popular electronic card index system. Easy to use, with powerful retrieval facilities.....£155  
**FRIDAY**: End user file management system from the authors of dBASE II. File definition, input and reporting under user control.....£195  
**OPEN ACCESS**: Multi-function Executives Information System.....£450  
**RETRIEVE II**: Information Management with unique features.....£495

# Telesystems Ltd

PO Box 12 Great Missenden Bucks Tel: 02406 5314

## LANGUAGES

Microsoft	CP/M	MSDOS	Digital Research	CP/M	CP/M-PCDOS	86
BASIC Interpreter	£279	£279	CBASIC Interpreter	£100	£217	
BASIC Compiler	£295	£303	CBASIC Compiler	£333	£400	£400
FORTRAN Compiler	£399	£279	PASCAL/MT+	£233	£400	£400
COBOL Compiler	£549	£575	C Compiler	£233	£233	
C Compiler		£399	PERSONAL BASIC Int		£100	
PASCAL		229	CIS COBOL	£425	£425	
BUSINESS BASIC		£469	FORMS-2	£110	£110	
Comp						
MACRO ASSEMBLER	£159	£99	FILESHARE	£250	£425	
SUPERSOFT C Comp	£185	£185	SUPERSOFT BASIC		£200	£200
PROFORTRAN	£220	£320	Compiler		£220	£320
			PRO PASCAL		£220	£320

## UTILITIES

**ASCOM**: The most flexible asynchronous communications package available to the micro world. Interactive, batch, menu-driven. Available for CP/M, CP/M-86, MSPCDS.....£140  
**BSTAM**: Simple communications program for exchanging files between CP/M systems.....£140  
**TRANSFER**: System for exchanging files between CP/M systems. Provided with full 8080 source code.....£130  
**CONVMS**: Operating system converter. Runs MSDOS programs under CP/M-86.....£70  
**CONVCP**: Operating system converter. Runs CP/M-86 programs under MSDOS.....£70  
**ASSEMBLER PLUS**: Disassembler for 8080 and Z80 programs.....£133  
**DISKEDIT**: Facility for editing disk held data by sector. Invaluable aid.....£70  
**IBM-CP/M COMPATIBILITY**: Set of programs that enable IBM 3740 disks to be used on CP/M, permitting transfer of files to/from IBM mainframes.....£110  
**SPP**: Speed Programming Package for use with Pascal/MT+.....£133  
**XL786**: Converts 8080 assembler code to 8086.....£106  
**EM80/86**: Emulator to run CP/M software under CP/M-86.....£70  
**DISPLAY MANAGER**: Screen handling productivity aid for Digital Research compilers.....£267  
**ACCESS MANAGER**: File handling productivity aid for Digital Research compilers.....£200  
**EXPRESS BASE II**: Development aid for dBASE II.....£125

## APPLICATIONS

**MULTIPLAN**: Exceptional electronic worksheet from Microsoft.....£159  
**MULTI-TOOL WORD**: Microsoft's advanced Word Processor with optional Mouse for added flexibility.....£299  
**SUPERCALC**: Fast action spreadsheet and planning aid.....£200  
**ABSTAT**: Powerful statistics package.....£295  
**GRAPHSTAT**: Versatile statistics and graphics package for the Epson QX10, IBM-PC and Sirius.....£195  
**ALIAS ACCOUNTS**: Fully integrated accounts system with inbuilt hooks to dBASE II.....£1200  
**ALIAS PAYROLL/SSP**: Standalone or integrated system with optional links to ALIAS accounts.....each £600  
**RCS LEDGERS**: Sales, Purchase, Nominal ledgers in MBASIC source code.....each £300  
**RCS PAYROLL**: Full function, highly used package.....£500  
**STATISTICS PACK**: Over 25 easily used routines in MBASIC.....£120  
**MATHS PACKAGE**: Interactive routines (40+) in MBASIC.....£120

## MISCELLANEOUS

**CP/M 2.2**: Standard operating system on 8" disk.....£100  
**CP/M-86**: Standard 16-bit operating system.....£167  
**SUPERSORT**: Full function Sort/Merge/Selection package.....£145  
**MSORT**: Standalone and COBOL hosted Sort package.....£149  
**MAGSAM**: MBASIC utility to provide multi-key ISAM file facilities.....£130  
**TOUCH 'N' GO**: Teach yourself keyboard skills.....£29  
**MICROSOFT MOUSE**: Mouse, interface card and software.....£149  
**OPTIMISER**: Interactive Linear Programming package.....£325  
**PROSTAR TRAINING GUIDE**: Independent instruction on the use of MicroPro 'STAR' products.....£30

PLEASE CALL FOR FULL LIST

DEALER ENQUIRIES INVITED

# Keeping out of the red

Paul Cobb's program for the 48K Spectrum keeps track of regular payments passing through your budget account.

DO YOU TREMBLE at the top of the stairs wondering what awaits you inside that windowed brown envelope lying on your doormat? In the course of a year each of us receives a staggering number of bills, and ensuring that cash is available to pay them all on time can be a major exercise.

The best way to deal with the majority of bills is through a budget account. You estimate and schedule your bills over a year and arrange to have the necessary funds available to meet them. If this money is kept in an interest-earning account at a bank or building society, then you begin to save money. The new chequebook with savings accounts, such as Abbey National's Cheque-Save account, are eminently suitable for you to operate your personal budget.

The program I have written lets you establish and maintain a budget account on a 48K Spectrum. It also records what you actually spend against the amount budgeted in order to help you produce a more accurate forecast the following year.

Most of the data is stored in early arrays. Using Goto 200 rather than Run after the first use of the program ensures that these arrays are not cleared of data. Line 9530 ensures that the program is saved so as to start with a Goto 200.

(continued on page 98)

Below: Figure 2. The menu presents the six options available.

Below: Figure 1. A typical printout indicating cash flow.

BUDGET ACCOUNT 1984		
MONTH	BUDGET (£)	SPENT (£)
Electricity		
January	100	0.00
April	75	0.00
August	50	0.00
December	75	0.00
Gas		
February	150	0.00
May	75	0.00
August	50	0.00
November	75	0.00
Water		
March	35	0.00
May	35	0.00
September	35	0.00
October	35	0.00
Holiday		
April	100	0.00
August	300	0.00
Telephone		
March	35	0.00
August	35	0.00
October	35	0.00
December	35	0.00
Clothes		
January	30	0.00
March	30	0.00
May	30	0.00
July	30	0.00
September	30	0.00
November	30	0.00
Car tax	85	0.00
Car service	65	0.00
March	100	0.00
August	100	0.00
November	130	0.00
December	200	0.00

## SELECT YOUR OPTION

- 1...Prepare annual budget
- 2...Display budget A/C
- 3...Display monthly budget
- 4...Display individual budget / Record expenditure
- 5...Print annual budget
- 6...Exit

BUDGET=£2125

ORDER=£180

purposes it may be  
make single  
the budget account  
one month. If this  
months and amounts  
below...

£35  
£20



```

10 REM ©1984 P H Cobb
97 LET a=0
98 GO TO 100
99 LET a=1
100 DIM i$(16,12,12): DIM a(16,
12): DIM s$(16,12): DIM b(16,12):
DIM b$(16,12,12): DIM m$(12,9)
110 LET x=0
120 FOR i=1 TO 12
130 READ m$(i)
140 NEXT i
150 DATA "January", "February", "
March", "April", "May", "June", "Jul
y", "August", "September", "October",
"November", "December"
190 IF a=1 THEN GO TO 1008
200 CLS: PRINT AT 1,7;"SELECT
YOUR OPTION"
210 PRINT AT 4,1;"1...Prepare a
nual budget"
220 PRINT AT 7,1;"2...Display b
udget A/C"
230 PRINT AT 10,1;"3...Display
monthly budget"
240 PRINT AT 13,1;"4...Display
individual budget / Reco
rd expenditure"
245 PRINT AT 17,1;"5...Print an
nual budget"
250 PRINT AT 20,1;"6...Exit"
260 GO SUB 9000
270 IF INKEY$="1" THEN GO TO 10
00
280 IF INKEY$="2" THEN GO TO 80
00
290 IF INKEY$="3" THEN GO TO 40
00
300 IF INKEY$="4" THEN GO TO 50
00
305 IF INKEY$="5" THEN GO TO 60
00
310 IF INKEY$="6" THEN GO TO 95
00
320 GO TO 200
1000 CLS: PRINT AT 1,5;"BUDGET
PREPARATION"
1002 PRINT AT 3,3;"This part of
the program deletes any budg
et already in the computer, so
a printout should be obtain
ed before proceeding."
1003 PRINT AT 9,3;"Press the ""m
"" key to return to the menu:"
PRINT AT 12,3;"Press the ""d"" k
ey to continue"
1004 GO SUB 9000: IF INKEY$(">"d"
) THEN GO TO 200
1005 RUN 99
1008 INPUT "Enter year (eg 1983)
...";y$
1010 INPUT "Enter month from whi
ch you want the budget to start
(eg January =1)...";k
1100 INPUT "Enter a description
of the new budget item (max. 12
characters) or 0 if the budget a
ccount is complete...";q$
1110 IF q$="0" THEN GO TO 1160
1115 LET x=x+1
1117 CLS: PRINT AT 1,5;"BUDGET
PREPARATION"
1120 INPUT "Enter the first mont
h in which a budgetary allocati
on is to be made (e.g. March=3)
...";z
1127 PRINT: PRINT "MONTH", "AMOU
NT £"
1130 INPUT "Enter amount you wis
h to budget for ";(q$), " in ";(m
$(z))"...£";s(x

```

Lines in the listing with reversed characters should read as follows:

```

200 CLS: PRINT AT 1,7;"SELECT YOUR OPTION"
1000 CLS: PRINT AT 1,5;"BUDGET PREPARATION"
1117 CLS: PRINT AT 1,5;" ";q$;"Budget"
4000 CLS: PRINT AT 1,5;"BUDGET ACCOUNT"
5000 LET z$="": CLS: PRINT AT 1,5;"BUDGET ACCOUNT"
5105 CLS: PRINT AT 1,5;" ";z$;"Budget"
6010 LPRINT AT 1,5;"BUDGET ACCOUNT ";y$
6037 LPRINT i$(i,g)
8000 CLS: PRINT AT 1,5;"BUDGET PREPARATION"
8012 CLS: PRINT AT 1,5;"BUDGET PREPARATION"

```

```

;z)
1135 LET i$(x,z)=q$
1138 PRINT m$(z),s(x,z)
1140 INPUT "Enter the next month
in which a budgetary allocati
on is to be made or 0 if the bud
get for ";(q$)" is complete
...";z
1145 IF z=0 THEN GO TO 1130
1150 GO TO 1130
1160 LET budget=0
1165 FOR i=1 TO 16
1170 FOR m=1 TO 12
1180 LET budget=budget+a(i,m)
1190 NEXT m: NEXT i
2000 LET order=INT (budget/12+1)
2010 CLS
2020 PRINT AT 5,3;"TOTAL BUDGET
=£";budget
2030 PRINT AT 8,1;"A monthly sta
nding order of £";order;" sho
uld be paid into the budget
account"
2035 INPUT "Enter the amount you
wish to pay by standing order i
nto the budget account...£"
;order
2040 INPUT "Enter the current ba
lance of the budget account...£";
status
2045 CLS: INPUT "Enter minimum
balance you wish to keep in Bud
get a/c...£";min
2050 GO TO 200
4000 CLS: PRINT AT 1,5;"BUDGET
ACCOUNT"
4005 LET spent=0: LET nbudget=0
4010 INPUT "Enter month (eg June
=6)...";m
4015 PRINT AT 1,21;m$(m)
4020 FOR i=1 TO 16
4030 FOR z=k TO m-1
4040 LET spent=spent+s(i,z)
4050 LET nbudget=nbudget+s(i,z)
4060 NEXT z: NEXT i
4062 IF m>1 THEN GO TO 4065
4064 PRINT AT 3,1;"Situation at
end of December": GO TO 4070
4065 PRINT AT 3,1;"Situation at
end of ";m$(m-1)
4070 LET v=spent: GO SUB 9660: P
RINT AT 4,3;"BUDGET £";nbudget;A
T 4,17;"SPENT £";v$
4081 LET nstatus=status: FOR i=k
TO m: LET nstatus=nstatus+order
4083 FOR g=1 TO 16: LET nstatus=
nstatus-s(g,i)+b(g,i): NEXT g
4084 NEXT i
4085 LET v=nstatus: GO SUB 9660:
PRINT AT 5,3;"BUDGET A/C BALANC
E £";v$
4086 FOR i=1 TO 16: LET nstatus=
nstatus-a(i,m): NEXT i
4087 IF nstatus>=min THEN GO TO
4090
4089 PRINT AT 7,1; FLASH 1;"F/C
BALANCE AT END OF MONTH IS BELO
W THE MINIMUM."; FLASH 0;"ADDITI
ONAL PAYMENT NECESSARY=£";min
-nstatus
4090 PRINT AT 10,1;"Budgetary al
locations have been made for ";(
m$(m))" as follows..."
4100 PRINT AT 13,5;"ITEM"; AT 13,
20;"AMOUNT(£)"
4110 LET n=14
4120 FOR i=1 TO 16
4130 IF a(i,m)=0 THEN GO TO 4150
4140 PRINT AT n,3;i$(i,m); AT n,2
0;a(i,m)
4145 LET n=n+1
4150 NEXT i
4152 PRINT #1; AT 0,1;"Do you wan
t hardcopy?"
4154 GO SUB 9000
4156 IF INKEY$(">"y" THEN GO TO 4
150
4158 COPY
4160 PRINT #1; AT 0,1;"Do you req
uire details of an individual
account?"
4170 GO SUB 9000
4180 IF INKEY$(">"y" THEN GO TO 2
00
5000 LET z$="": CLS: PRINT AT 1
,5;"BUDGET PREPARATION"

```

(listing continued on next page)

(continued from page 96)

On entering and running the program you will be presented with the menu shown in figure 2. Option 1 allows you to delete any existing budget and establish a new one, but before doing so it is advisable to obtain a printout of the old budget. The program lets you return to the menu if necessary.

Pressing the D key presents you with a number of questions to answer to raise your budget. It normally runs from January to December, but you can begin at any month in the year, and construct a new budget in the following January. Minor re-programming will enable you to budget from April to March if you prefer it, by beginning the Data strings in line 150 at April.

When your budget is finally complete the computer will tell you how much you should pay into your budget account each month in order to meet the bills. You then enter the amount you wish to pay, the current balance of the account and the minimum balance you wish to retain in the account. The computer will then return you to the menu.

Option 5 gives a printout of your annual

budget, which will also advise you of potential cash-flow problems.

A constant monthly payment into your budget account is not going to be enough if all of your bills arrive in January and you have a low initial balance in your budget account. The computer printout indicates any months where you have a cash-flow problem and tells you of any additional payments needed to meet that month's expected bills. A typical printout is given in figure 1.

Once you have prepared your budget the amount you have allowed for bills in a particular month can be displayed by selecting option 3 from the menu. It shows the amount you have spent at the end of the previous month against the amount you have allowed, as well as the current balance and bills budgeted for in the current month. Figure 3 shows a sample printout of the monthly budget.

If you are about to go below the minimum sum you want to maintain in the budget account the computer flashes a warning and tells you how much to pay in. It also offers you the option of obtaining further details about an individual budget before returning you to the menu.

As bills are paid from your budget account you can either enter them into the computer as you go along or wait until the end of the month and enter them all together. Either way you should select option 4 from the menu. This will flash a budget item at you and invite you to keep pressing the Z key until the item you require is indicated. Pressing the X key at this point takes you to an individual item account, as shown in figure 4. You can then enter details of any bills paid before you are returned to the menu.

Option 2 provides an account of all transactions in the budget account and lets you enter credits and debits for budgeted and non-budgeted items. This option is used when you have paid a budgeted bill out of another account. You still record the amount paid in the budget account, you will also have to credit the account by an equal amount to preserve the true balance of the account. A typical display is shown in figure 5.

Option 5 is used to the end of the year to give a printout of the year's budget together with amounts actually spent. This information can be used as a guide for the next year's budget.

(listing continued from previous page)

```
6010 PRINT AT 5,1;"Press the ""z
"" key until the appropriate
item flashes below.
"
6020 PRINT "When the item you re
quire is shown,press the ""x""
key."
6030 LET x=0: LET n=0
6040 FOR i=1 TO 16
6045 FOR m=1 TO 12
6048 IF x=1 THEN GO TO 5100
6049 IF z$=i$(i,m) OR a(i,m)=0 T
HEN GO TO 5100
6050 PRINT AT 20,5; FLASH 1;i$(i
,m)
6055 LET z$=i$(i,m)
6060 GO SUB 9000
6070 IF INKEY$<>"X" THEN GO TO 5
0000
6075 LET x=1
6082 PRINT AT 20,1;"
"
6090 LET n=n+1
6100 NEXT m: NEXT i
6105 IF x=0 THEN GO TO 5000
6105 CLS: PRINT AT 1,5;"
"
6110 LET c=4
6110 PRINT AT 3,3;"MONTH":AT 3,1
0;"BUDGET(£)":AT 3,24;"SPENT(£)"
6130 FOR m=1 TO 12
6140 IF s(n,m)=0 AND a(n,m)=0 TH
EN GO TO 5600
6150 LET v=s(n,m): GO SUB 9660:
PRINT AT c,1;m$(m),AT c,15;a(n,m
);AT c,25;v$
6160 LET c=c+1
6170 NEXT m
6180 PRINT #1;AT 0,1;"Do you wis
h to record payment of any bit
t?"
6190 GO SUB 9000
6200 IF INKEY$<>"y" THEN GO TO 2
000
6235 INPUT "Enter month of bill
(eg July=7) . . .";m
6240 INPUT "Enter amount of bill
£";s(n,m)
6245 LET i$(n,m)=z$
```

```
5650 GO TO 5105
6000 CLS: PRINT AT 10,5; FLASH
1;"BUDGET PRINTOUT"
6010 LPRINT,AT 1,5;"BUDGET ACCO
UNT"
6020 LPRINT: LPRINT AT 3,4;"MON
TH":AT 3,13;"BUDGET(£)":AT 3,24;
"SPENT(£)"
6030 FOR i=1 TO 16
6031 LET x=0
6032 FOR m=1 TO 12
6033 IF x=1 THEN GO TO 6038
6035 IF a(i,m)=0 THEN GO TO 6036
6036 LET x=1
6037 LPRINT i$(i,m)
6038 NEXT m
6040 FOR m=1 TO 12
6050 IF a(i,m)=0 THEN GO TO 6070
6055 LET v=s(i,m): GO SUB 9660:
LPRINT TAB 4,m$(m);TAB 15;a(i,m)
;TAB 25;v$
6070 NEXT m
6080 NEXT i
6081 LPRINT: LPRINT
6082 LPRINT TAB 5;"TOTAL BUDGET="
£";budget
6084 LPRINT: LPRINT: LPRINT TA
B 5;"STANDING ORDER="£";order
6110 LET surp=surp-status-min
6115 LET f=0
6119 LPRINT: LPRINT
6120 LPRINT "For cash flow purpo
ses it may be necessary to make s
ingle payments into the b
udget account for periods of one
month. If this is the case months
and amounts will be shown below
"
6130 LPRINT: LPRINT
6140 FOR m=k TO 12
6150 FOR i=1 TO 16
6160 LET surp=surp-a(i,m)
6170 NEXT i
6175 LET surp=surp+order
6180 IF surp=0 THEN GO TO 6200
6190 LPRINT m$(m),"£"-surp
6195 LET f=1
6200 NEXT m
6205 IF f=1 THEN GO TO 6220
6210 LPRINT "No additional payme
nts necessary": GO TO 200
6220 CLS: BEEP 1,1: PRINT "If a
cash flow problem is likely in a
particular month, then this will
```

**BUDGET REPORT** May  
 Situation at end of April  
 BUDGET £555 SPENT £682.52  
 BUDGET A/C BALANCE £517.48

Budgetary allocations have been made for May as follows..

ITEM	AMOUNT (£)
Gas	75
Water	35
Clothes	30

**BUDGET ACCOUNT** April

S/Order	ITEM	AMOUNT	BALANCE
	Electricity	180	480.00
	Clothes	-90.00	390.00
	Order	-12.50	377.50
	Interest	180	557.50
	Gas	12.30	569.80
	Order	-134.79	435.01
	Water	180	615.01
	Telephone	-33.12	581.89
	Clothes	-46.80	535.09
	Service	-34.55	500.54
	Order	-123.09	377.45
	Electricity	180	557.45
	and	-60.46	496.99
	day	25.08	471.91
		-123.40	348.51

**Electricity Budget**

MONTH	BUDGET (£)	SPENT (£)
January	100	96.00
April	75	83.40
August	50	6.00
December	75	0.00

Above: Figure 5. Budget account display.  
 Top left: Figure 3. Monthly budget display.  
 Bottom left: Figure 4. Item budget display.

be notified on the "monthly" budget display."

```
8025 PAUSE 300
8030 GO TO 200
8000 CLS : PRINT AT 1,5; "BUDGET"
8010 INPUT "Enter month (eg June"
8012 PRINT AT 1,5; "BUDGET"
8015 PRINT AT 1,20; "($)"
8020 PRINT AT 3,1; "MONTH" AT 3,8; "ITEM" AT 3,17; "AMOUNT" AT 3,25; "BALANCE"
```

```
8025 LET nstatus=status
8030 LET n=n+1
8040 FOR i=k TO n
8050 LET nstatus=nstatus+order
8060 LET v=nstatus: GO SUB 9660: PRINT AT n,1; "S/Order" AT n,17; "order" AT n,25; v$
8065 LET n=n+1
8064 LET g=0
8065 FOR c=1 TO 16
8068 IF s(c,i)=0 THEN GO TO 8080
8069 LET nstatus=nstatus-s(c,i)
8070 PRINT AT n,5; i$(c,i): LET v=s(c,i): GO SUB 9660: PRINT AT n,17; "-": v$: LET v=nstatus: GO SUB 9660: PRINT AT n,25; v$
8072 LET n=n+1
8073 IF n=20 THEN GO TO 8078
8074 GO TO 8068
8078 PRINT #1; AT 0,1; "Continue?" : GO SUB 9000
8079 IF INKEY$("<") THEN CLS : LET n=4: GO TO 8080
8080 IF b(c,i)=0 THEN GO TO 8089
8081 LET g=g+1
8082 LET nstatus=nstatus+b(c,i)
8083 LET v=b(c,i): GO SUB 9660: PRINT AT n,5; b$(c,i) AT n,17; v$: LET v=nstatus: GO SUB 9660: PRINT AT n,25; v$
8084 LET n=n+1
8085 IF n=22 THEN GO TO 8087
8086 GO TO 8089
8087 PRINT #1; AT 0,1; "Continue?" : GO SUB 9000
8088 IF INKEY$("<") THEN GO TO 8089
```

```
8089 NEXT c
8090 NEXT i
8091 PRINT #1; AT 0,1; "Press c/d/"
8095 GO SUB 9000
8096 LET x$=INKEY$
8110 IF x$="c" THEN GO TO 8200
8120 IF x$="d" THEN GO TO 8140
8130 GO TO 200
8140 CLS : PRINT AT 8,1; "Is this payment of a bill for which a budgetary allocation has been made?"
8150 GO SUB 9000
8160 IF INKEY$="y" THEN GO TO 50
8200 CLS : INPUT "Enter the amount.": b(g+1,m)
8210 INPUT "Enter a description.": b$(g+1,m)
8220 IF x$="d" THEN LET b(g+1,m)=-b(g+1,m)
8230 GO TO 8012
9000 IF INKEY$("<") THEN GO TO 90
9010 IF INKEY$="" THEN GO TO 901
9020 PRINT #1; AT 0,1; "
9030 RETURN
9500 CLS : PRINT AT 10,1; "Have you made any changes?"
9510 GO SUB 9000
9520 IF INKEY$("<")="y" THEN GO TO 9550
9530 SAVE "budget" LINE 200
9550 CLS : PRINT AT 10,10; FLASH 1; "GOODBYE"
9555 STOP
9660 IF v=0 THEN LET v$="0.00": RETURN
9670 LET v$=STR$ v
9680 IF v$(1)="" THEN LET v$="0"+v$
9685 IF LEN v$=1 THEN LET v$=v$+".00"
9690 IF v$(LEN v$-1)="" THEN LET v$=v$+"0"
9710 LET j=0
9720 FOR i=1 TO LEN v$
9730 IF v$(i)="" THEN LET j=i
9740 NEXT i
9750 IF j=0 THEN LET v$=v$+".00"
9760 RETURN
```

# 1. KEEP TRACK OF THE GOLF CLUB ACCOUNTS.

The GEC Dragon RMS program will record all the details, and prepare the accounts beautifully typed at the end of the year. (Or any other time.)

# 2. ACHIEVE INSTANT FINANCIAL STATUS.

Whether you're in business or not, the Dragon will give you an accurate picture of your assets (or liabilities) almost instantly.

# "What else would I do with a GEC Dragon 64?"

# 3. MAKE SURE THE CASH FLOWS IN, AS WELL AS OUT.

With the Sales and Purchase program soon to be available, you'll have complete control over your company's cash flow.

# 4. LEARN TO PROGRAM IN PASCAL, C, OR BASIC.

Although it's child's play to use, the GEC Dragon is certainly not limited to games. In fact it has as much brain power as some computers that cost thousands.

# 5. COST OUT JOBS.

Many small businesses are using the GEC Dragon to simplify and speed up their complete job-costing operations — and saving a fortune in the process.

# 6. INTEGRATE YOUR POLYNOMIALS.

GEC Dragon's UNIX-like software to the rescue again. If you can handle the maths, the GEC Dragon will take care of all the calculations.

# 7. SEND A SHIRTY LETTER TO THE BANK MANAGER FOR A CHANGE.

You should enjoy this. The Dragon is a big ally when it comes to personal finance. It'll keep you permanently one step ahead of your bank statements.



# 8. TURN YOUR EXPENSES FROM FICTION INTO FACT.

Keep a day-by-day account of your business expenses and credit card transactions — with instant printout at any time.

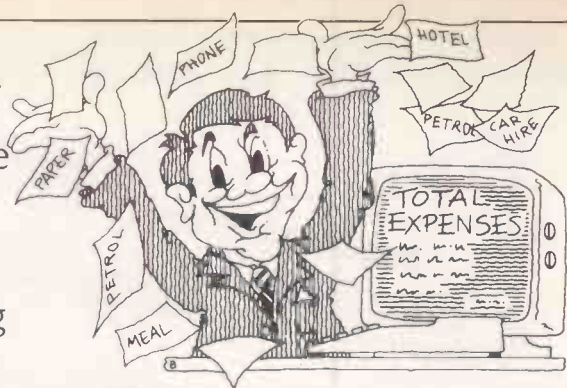

# 9. DESIGN A BRIDGE.

GEC Dragon's UNIX-like software (based on programs which were specifically designed for universities) will help you perform stress analysis, quantity surveying and many more complex functions.

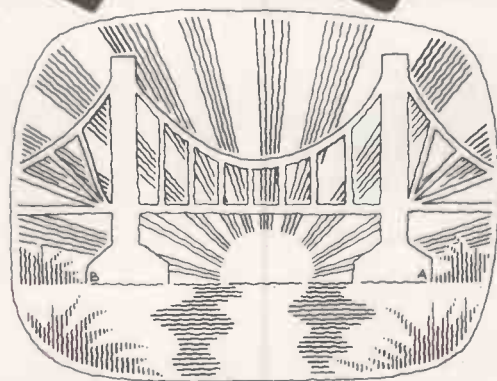

## 10. FIND A CURE FOR AMNESIA.

By keeping a personal diary, the GEC Dragon can also help you avoid life's bigger crises. (Like reminding you of your anniversary before your wife does.)

## 11. FLY TO THE MOON.

While you're taking it easy with all the spare time your Dragon has created, there are literally hundreds of space adventures and other games to pass the time.

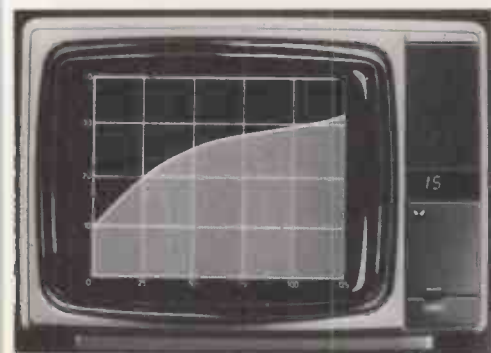

## 12. CURE THE IMPEDIMENT IN YOUR REACH.

By linking your Dragon to Prestel and the telephone, you'll have immediate access to the very latest information on travel and exchange rates. You can even book up for plays and the theatre.

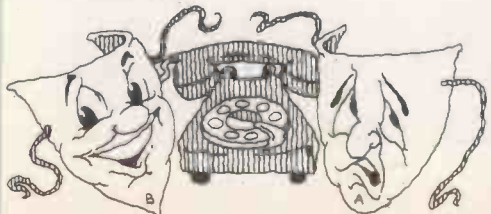

## 13. COMPOSE A MOONLIGHT SONATA - ANY TIME OF DAY.

With no less than five octaves, the GEC Dragon is musically very talented.



It's no dumb computer, either - you can even get it to talk to you.



## 14. WRITE YOUR LIFE STORY.

You'll get around 30,000 words of gripping adventure or stunning success on every GEC Dragon 64 floppy disk.

## 15. TEACH THE KIDS.

From over thirty educational programs, you can teach your children to read and write from a very early age.



There are lots more ways the GEC Dragon 64 can make life simpler.

You can buy the GEC Dragon computer and a wide range of accessories and software from the better computer shops, major stores and GEC dealers.

It's proof that, now GEC and Dragon have got together, we're really going to start turning it on for the small business and serious computer user.

And to whet your appetite still further, we've produced a 12-page colour brochure that tells you how to get the most out of a GEC Dragon 64. It's called 'Your Passport to Professional Software.'

It's yours free in exchange for the coupon below.

# GEC DRAGON COMPUTERS

To: GEC Dragon Customer Services, Tripsgate House, Gladstone Drive, Staple Hill, Bristol BS16 4RU.  
Please send me a copy of 'Your Passport to Professional Software.'

Name \_\_\_\_\_

Address \_\_\_\_\_

Postcode \_\_\_\_\_

Or if you would like information on the rest of our products - please tick the appropriate box.

Dragon 32    Dragon 64    Dragon Accessories

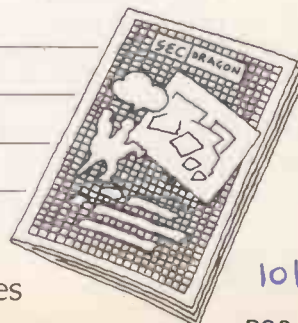

# Screen copier for CP/M

Recent CP/M implementations let you redirect screen output to another peripheral. With the Como utility by John and Timothy Lee you can do the same for any program running under CP/M.

HAVE YOU EVER wished that CP/M would allow you to redirect the output which normally goes to the screen to another device? Redirection of input and output is very poorly implemented in CP/M, and in many implementations the console output may only be sent to the standard console device, usually a VDU.

Better implementations of CP/M have the Iobyte fully installed. It allows any of the virtual devices — Console, List device, Punch or Reader — to be assigned to any of the real peripherals that may be connected to the microcomputer, that is to the VDU, printer, tape punch, tape reader or cassette interface. In these implementations, changing the Iobyte in the appropriate manner sends console output to any of the other real devices if required. Unfortunately no version of CP/M 2 or earlier allows the console output to be redirected to a disc file.

## Printed version

You can usually produce a printed version of what is usually sent to the screen by typing Control-P before running the program. All the characters that CP/M sends to the screen are then sent to the printer as well. Unfortunately Control-P does not always work; for example, it has no effect when you are running MBasic or WordStar. These programs call BIOS directly to send characters to the screen, rather than sending characters to the screen through CP/M by calling location 5.

If the Iobyte has been installed then it is usually possible to redirect console output from any program to a printer instead of the screen, because the Iobyte redirects characters from within BIOS. The Iobyte may be altered by running the program Stat before the run, or it may be changed from within MBasic. On a number of machines this can be done by typing the command Poke 3,1 to make the printer the output device, and typing Poke 3,0 to make the VDU the output device again. Other machines may require values other than 1 and 0 in the Poke command.

```

;
; ASEG ;These two lines are
; .8080 ;needed with M80
;
; The first three equates are the only items that may need
; changing for different CP/M systems.
;
; LOAD is the K size of TPA after COMO has been loaded.
; NB CP/M typically occupies about 7K.
; 0.75 K is needed for COMO itself plus space for
; the buffer as defined below.
0028 = LOAD EQU 40
;
; NSECT is the number of 128 byte sectors to buffer
; before writing to disk. NSECT = 16 is a 2K buffer.
0010 = NSECT EQU 16
;
; MBASIC is a flag to indicate whether COMO is to be used
; with programs such as MBASIC or WordStar that call BIOS
; directly to output characters. Set the flag to -1 for
; MBASIC or WordStar, or to 0 for conventional programs
; that call CP/M to output characters.
FFFF = MBASIC EQU -1
;
0000 = BIOS EQU 0 ;Address of BIOS is unknown at
;assembly time - hence zero
0000 = DUMMY EQU 0
0007 = BELL EQU 7 ;ASCII BELL
000A = LF EQU 10 ;ASCII LineFeed
000D = CR EQU 13 ;ASCII Carriage Return
0005 = CPM EQU 5 ;CP/M entry point
0009 = PRINTS EQU 9 ;CP/M PRINT String command
000F = OPENF EQU 15 ;CP/M OPEN File command
0010 = CLOSEF EQU 16 ;CP/M CLOSE File command
0015 = WRITES EQU 21 ;CP/M WRITE Sector command
0016 = CREATE EQU 22 ;CP/M CREATE file command
0100 ORG 100H
0100 C33A01 JMP PREINT
0103 0D0A0A434F DB CR,LF,LF,'COMO version 3'
0114 0D0A777269 DB CR,LF,'written by T.D.Lee'
0128 0D0A313020 DB CR,LF,'10 January 1984',26
;
; INITIALise Program
;
; This program splices 5 new subroutines into the BIOS jump
; table, opens file COMO.OUT and jumps back to the CCP.
; First however PRE-INIT finds out the address of BIOS
; and corrects all the references to BIOS in the rest
; of the code (the address of BIOS was not known at assembly)
013A 3A0200 PREINT: LDA 2 ;Get HI byte of BIOS address
013D 326301 STA B1+2 ;Correct first reference to BIOS
0140 326C01 STA B2+2 ; " second " " "
0143 326F01 STA B3+2
0146 327801 STA B4+2
0149 327B01 STA B5+2
014C 328401 STA B6+2
014F 328701 STA B7+2
0152 329001 STA B8+2
0155 328DA0 STA B9+2

```

```

0158 322AA2      STA      B10+2
015B 3230A2      STA      B11+2
015E 3236A2      STA      B12+2      ;Correct final reference to BIOS
;
;      End of PRE-INITialisation - all references to BIOS correct
;
;      Start of INITIALisation - splice new subroutines into
;      the BIOS jump table

INIT:
0161 2A0A00      B1:      LHL      BIOS+10      ;address of Conin Routine
0164 2204A0      SHLD     NCONIN
0167 2103A0      LXI      H,MONITR      ;put address of MONITR subr
016A 220A00      B2:      SHLD     BIOS+10      ;into BIOS Conin jump

016D 2A0D00      B3:      LHL      BIOS+13      ;address of Conout Routine
0170 22E4A0      SHLD     NCONOU
0173 21C3A0      LXI      H,COMOUT      ;put address of COMOUT subr
0176 220D00      B4:      SHLD     BIOS+13      ;into BIOS Conout jump

0179 2A2500      B5:      LHL      BIOS+37      ;address of SETDMA Routine
017C 227BA1      SHLD     NSTDMA
017F 216FA1      LXI      H,DMA         ;put address of DMA subr
0182 222500      B6:      SHLD     BIOS+37      ;into BIOS Setdma jump

0185 2A0400      B7:      LHL      BIOS+4       ;address of WBOOT Routine
0188 229BA0      SHLD     NWBOOT
018B 217BA0      LXI      H,WBOOT       ;put address of WBOOT subr
018E 220400      B8:      SHLD     BIOS+4       ;into BIOS Wboot jump

0191 2A0600      LHL      6              ;address of FDOS
0194 2201A0      SHLD     NFDOS
0197 2100A0      LXI      H,FDOS        ;put address of jump to
019A 220600      SHLD     6              ;FDOS at start of new code
;CP/M USES THIS TO DETERMINE
;THE SIZE OF THE TPA

019D CDF401      CALL     OPEN           ;Open file COMO.OUT
01A0 21A701      LXI      H,MESINT      ;put address of jump to
01A3 CD38A2      CALL     PRINT          ;Print Message
01A6 C9          RET                    ;Back to the CCP

01A7 0743F4D4FMESINT: DB      BELL,'COMO dormant - start and stop output '
01CD 746F206669 DB      'to file COMO.OUT by typing CONTROL-L',CR,LF,'$'

;
;      OPEN Subroutine
;
;      This Subroutine opens the File for receiving output
;      If the file does not exist, it is created.

01F4 0E0F      OPEN:   MVI      C,OPENF
01F6 114DA2      LXI      D,FCB
01F9 CD0500      CALL     CPM           ;Try to Open File
01FC 3C          INR      A
01FD C0          RNZ
;Return if file is open
;Otherwise the file does
;not exist - try to Create

01FE 0E16      MVI      C,CREATE
0200 114DA2      LXI      D,FCB
0203 CD0500      CALL     CPM           ;Try to Create File
0206 3C          INR      A
0207 C0          RNZ
;Return if file is now created

0208 211102      LXI      H,ERRDIR
020B CD38A2      CALL     PRINT          ;Print Error Message
020E C385A0      JMP      ERROR

0211 070D0A434FERRDIR: DB      BELL,CR,LF,'COMO failed - No directory space '
0235 746F206372 DB      'to create COMO.OUT',CR,LF,'$'

;
;      Main Subroutines
;
;      These reside in High Memory after COMO.COM has been
;      executed. INIT has changed the Jump Table in BIOS
;      so that Console Input/Output, Setdma and Wboot calls
;      to BIOS actually call these subroutines instead of
;      the original BIOS routines. These subroutines directly
;      call the routines in BIOS to achieve Conin,Conout,
;      Setdma,Wboot.

A000      ORG      LOAD*1024      ;Address at which
;to assemble Subroutines

;
;      The remaining code is executed
;      only thru intercepted BIOS calls

A000 C30000      FDOS:   JMP      DUMMY      ;Filled in by Init
A001 =          NFDOS  EQU      $-2

;
;      Monitor Subroutine

```

(listing continued on next page)

Suppose that you are writing documentation for a new program. The way to operate the program and its various functions might well be illustrated by including a trial run in the documentation, showing what is displayed on the screen. These screen images would show the messages printed by the computer, the data you typed in, and the results produced, and so on.

There is no direct way of copying the screen image under CP/M. Typing in the information to be displayed on the screen is slow, boring and potentially inaccurate. It would be faster and more reliable to run the program and get the computer to redirect the output produced by the program to a disc file. The disc file would then contain an exact copy of the output that the program produced, and this file could be read in and incorporated into the documentation with WordStar or another text editor. A sample run of a program is particularly useful for checking that it has been entered correctly.

Users of mainframe computers are accustomed to facilities for reading data from a file and sending output to a file. The popular Unix operating system for minicomputers and 16-bit micros allows

(continued on next page)

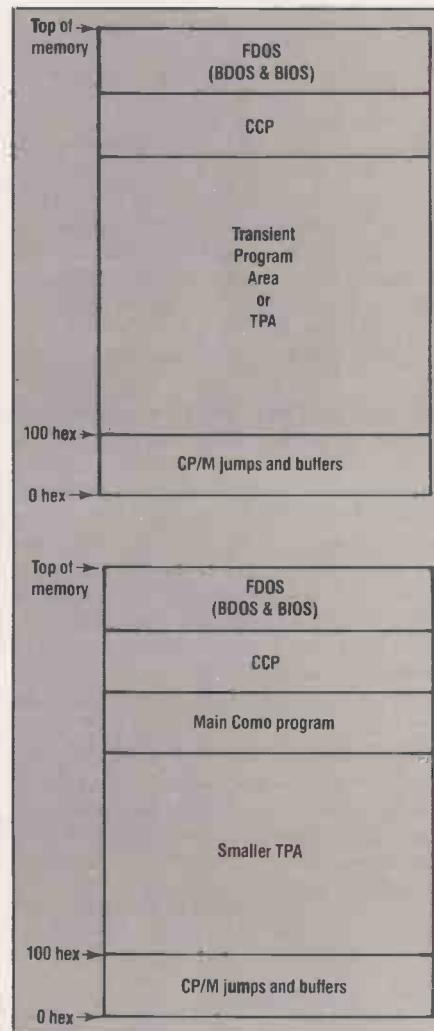

CP/M memory map before and after loading Como.

(continued from previous page)

output to be redirected to a file by adding  
> <file name>

to a Unix command. Alternatively, output can be sent to both a file and the screen by adding

|tee <file name>

to the Unix command. Prime mini-computers support the command

COMO <file name>

which sends all output to the file until the command Como-End is typed.

Users of CP/M have no such facilities. Standard versions of CP/M 2 have no facilities for redirecting output to a file. However, it is possible to replace the Current Command Processor of your CP/M by an alternative version which has additional features including the redirection of output. One alternative CCP, called Clip, is supplied by Thoughtware Software Inc., PO Box 41436, Tucson, Arizona 85717. Like CP/M Plus, Clip allows redirection of both input and output. Unfortunately, programs such as MBasic or WordStar that send their output directly to BIOS defeat the I/O redirection in Clip.

## Como.Com

We have written a program called Como.Com to allow redirection of output from any program to a file when running under CP/M. Como will copy output from any program to a file, even if the program sends its output directly to BIOS, because it intercepts the characters that BIOS is about to send to the screen. Even MBasic output, which is sent directly to BIOS, is copied to the file by Como.

To use Como, make sure that there is sufficient space on the disc you are using for the output file that you are going to produce, then type

COMO <file name>

or

B:COMO <file name>

CP/M loads the Como program, which does some initialisation, prints a message and returns you to CP/M command level. Como is now lying dormant in memory, and you may load MBasic and your application program.

Como is activated by typing a single Control-L. A starting message is displayed on the screen, and all console output is now sent to a file called Como.Out as well as to the console until either a second Control-L is typed, or CP/M is warm-booted. Como prints a starting message when the copying of output to the file is started, and a finishing message when the copying of output to the file is stopped, for example

A>COMO

COMO dormant — start and stop output to file COMO.OUT by typing CONTROL-L

A>MBASIC

Ok

LOAD "ACCOUNTS"

Type Control-L to start copying the console output to a file, and the message

Console Output is being copied to file

(listing continued from previous page)

```

; All Calls to Conin are routed thru here. This
; routine calls the Bios conin routine, and checks
; for ^L. When ^L is found re-direction is either
; started or stopped

A003 CD0000 MONITR: CALL DUMMY
A004 = NCONIN EQU $-2
A006 FE0C CPI 12
A008 C0 RNZ ;Return is char not ^L

A009 2249A2 SHLD OLDHDL ;Save HL
A00C 210000 LXI H,0
A00F 39 DAD SP
A010 2273A0 SHLD OLDST ;Save Old Stack at OLDST
A013 31C1AA LXI SP,STACK ;Set new stack
A016 D5 PUSH ;Save Registers DE
A017 C5 PUSH B ; and BC

A018 3A46A2 LDA COMOFL
A01B B7 ORA A
A01C C265A0 JNZ MON1

A01F 212DA0 LXI H,MESCPY
A022 CD38A2 CALL PRINT ;Print Message
VA025 3EFF MVI A,-1
A027 3246A2 STA COMOFL ;Set Como FLAG = TRUE
A02A C370A0 JMP MON2

A02D 070D0A2A2AMESCPY: DB BELL,CR,LF,**** Console Output is being
A04E 636F706965 DB 'copied to file ****',CR,LF,'$'

A065 3E00 MON1: MVI A,0
A067 3246A2 STA COMOFL ;Set Como FLAG = FALSE
A06A CD7DA1 CALL CLOSE ;Close Output Channel
A06D CD25A2 CALL UNINIT ;Reset BIOS jumps to
;Conin, Conout, Setdma

MON2:
; Restore other registers & stack to state before MONITR

A070 C1 POP B ;Restore BC
A071 D1 POP D ; and DE
A072 310000 LXI SP,DUMMY ;Restore old Stack
A073 = OLDST EQU $-2
A075 2A49A2 LHLD OLDHDL ;Restore HL
A078 3E00 MVI A,0
A07A C9 RET ;Return a NULL character

; WBOOT routine
; Calls to Wboot are routed thru here
; This routine closes the output file if it was open,
; restores the original BIOS jump table,
; then does Warm Boot, thus completely restoring CP/M
; as if COMO had never been used
; NB If an error occurs in COMO, control is passed here
; for an orderly exit and Warm Boot

A07B 3A46A2 WBOOT: LDA COMOFL
A07E B7 ORA A
A07F CA88A0 JZ WBOOT3
A082 CD7DA1 CALL CLOSE ;Close file if Open

A085 CD25A2 WBOOT2: CALL UNINIT ;Restore Bios Jumps for
;Conin, Conout, Setdma

A088 2A9BA0 WBOOT3: LHLD NWBOOT ;Restore BIOS Wboot jump
A08B 220400 B9: SHLD BIOS+4 ;Restore top of TPA

A08E 2A01A0 LHLD NFDOS
A091 220600 SHLD 6

A094 219DA0 LXI H,MESDIS
A097 CD38A2 CALL PRINT

A09A C30000 JMP DUMMY ;Do Warm Boot
A09B = NWBOOT EQU $-2

A09D 070D0A2A2AMESDIS: DB BELL,CR,LF,**** COMO has disappeared ****
A0C0 OD0A24 DB CR,LF,'$'

; COMOUT routine
; All calls to CONOUT are routed thru here
; This routine sends character to File as well as
; to BIOS conout if COMOFL is TRUE
; nb. COMOFL is set TRUE by MONITR when a ^L is typed

A0C3 2249A2 COMOUT: SHLD OLDHDL
A0C6 210000 LXI H,0

```



```

AOC9 39          DAD    SP
AOCA 22DEAO      SHLD   OLDSK
AODC 31C1AA      LXI    SP,STACK
AODD D5          PUSH   D
AOD1 C5          PUSH   B
AOD2 F5          PUSH   PSW

AOD3 3A46A2      LDA    COMOFL
AOD6 B7          ORA    A          ;If Flag is TRUE then
AOD7 C4E6A0      CNZ    BUFCHR      ;Put Char in File buffer

; Reset registers and stack to their state before COMOUT

AODA F1          POP    PSW
AODB C1          POP    B
AODC D1          POP    D
AODD 310000      LXI    SP,DUMMY      ;Restore old Stack
AODE =          OLDSK EQU    $-2
AOE0 2A49A2      LHLD   OLDHDL

AOE3 C30000      CONOU: JMP    DUMMY      ;Filled in by INIT
AOE4 =          NCONOU EQU    $-2

; BUFCHR subroutine
; This routine puts the character in the C register
; into the file buffer, and keeps a count of the number
; of characters in the buffer. When the buffer is full,
; the routine calls WRITE to write the buffer full to disk.

AOE6 2A4BA2      BUFCHR: LHLD   COUNT
AOE9 54          MOV    D,H
AOEA 5D          MOV    E,L          ;DE = count
AOEB 2171A2      LXI    H,BUFFER
AOEE 19          DAD    D          ;HL = pointer to buffer
AOEF 71          MOV    M,C          ;put Character in buffer
AOF0 2A4BA2      LHLD   COUNT
AOF3 23          INX    H          ;increment count
AOF4 224BA2      SHLD   COUNT      ;save COUNT
AOF7 1100F8      LXI    D,-NSECT*128
AOF8 19          DAD    D          ;HL = Count - Nsectors * 128
AOFB 7C          MOV    A,H
AOFD C0          ORA    L
;Return unless buffer full
;otherwise Write to disk

; WRITE Subroutine
; This subroutine writes NSECT sectors of 128 bytes to disk.
; The routine sets CP/Ms DMA buffer to the output BUFFER,
; and writes a single sector. The CP/M DMA buffer is then
; changed and the second sector is written, and so on.
; Finally the subroutine restores the original DMA buffer.
; NB. CP/M does not allow a program to determine the current
; DMA buffer address - hence this program intercepts all
; all requests to change the DMA buffer address, and
; hence always knows how to restore the original DMA buffer.

AOF8 0171A2      WRITE: LXI    B,BUFFER      ;Address of first sector
A101 3E10          MVI    A,NSECT      ;Number of sectors to write
A103 F5          WRITE2: PUSH PSW
A104 C5          PUSH   B          ;Save Current output buffer
;address on stack
;Set DMA buffer = output BUFFER

A105 CD7AA1      CALL   SETDMA
A108 0E15          MVI    C,WRITES
A10A 114DA2      LXI    D,FCB
A10D CD0500      CALL   CPM          ;Get CP/M to write a sector

A110 B7          ORA    A
A111 CA54A1      JZ     WRITOK      ;Jump if Write was successful

A114 211DA1      LXI    H,WRTErr
A117 CD38A2      CALL   PRINT
A11A C385A0      JMP    ERROR      ;Print Error Message
A11D 070D0A434FWRTErr: DB    BELL,CR,LF,'COMO failed - Error whilst '
A13B 7772697469 DB    'writing output to disk',CR,LF,'$'

A154 C1          WRITOK: POP    B          ;Get output buffer address
A155 F1          POP    PSW
A156 218000      LXI    H,128
A159 09          DAD    B          ;HL = address of next sector
A15A 44          MOV    B,H
A15B 4D          MOV    C,L          ;BC = address of next sector
A15C 3D          DCR    A          ;one less sector to write
A15D C203A1      JNZ   WRITE2      ;loop until all sectors written

A160 2A47A2      LHLD   CPMDMA      ;Get CP/M DMA address in HL
A163 44          MOV    B,H
A164 4D          MOV    C,L          ;BC = CP/M DMA address
A165 CD7AA1      CALL   SETDMA      ;Restore original DMA buffer
A168 210000      LXI    H,0

```

(listing continued on next page)

appears. The program runs to completion, and MBasic gives a prompt

OK

Type Control-L again to end output to the file. Como is still in memory even though it is no longer being used, and displays the message

Console output is no longer being copied to file

Type

SYSTEM

to exit from MBasic, and return to CP/M. MBasic warm-boots CP/M, which makes Como disappear from memory, whereupon Como prints a message

COMO disappeared

Como works in two distinct phases. First, when Como is typed the file Como.Com is loaded into memory and a small piece of initialisation code is executed. The main code for Como is loaded into the top of the TPA, just below the beginning of the CCP and is not executed at this time. The small piece of initialisation code changes BIOS so that all subsequent console input/output is passed to the main Como program.

## Extreme care

The main Como program contains routines for buffering the console output and writing it to disc, for monitoring console input looking for Control-L, which is used to switch the copying of output to file On or Off. The subroutines have to be very careful to leave everything exactly as it was before the subroutine was entered, or the program whose output is being copied will malfunction or crash.

The main Como program is modular and comprises a set of subroutines, each of which performs a simple well-defined task. The first of these is the Monitr routine, which intercepts all characters typed on the keyboard. Monitr usually passes the character back to CP/M unchanged, except for the character Control-L.

The first time that Control-L is intercepted a flag called Comofl is set, and a null character is returned to CP/M. The second time that Control-L is intercepted, Monitor unsets the Comofl flag, calls the Close subroutine to close the output file, and calls Uninit to uninitialise before returning a null character to CP/M.

A similar routine called Comout intercepts all Console output — the characters that should appear on the VDU screen. Unless the Comofl flag is set Comout does nothing, but if the flag is set it calls the Bufchr subroutine to put the character in the output buffer.

Bufchr puts the character into the output buffer and increments the count of the number of characters in the buffer. Bufchr then checks to determine whether the buffer is full. If it is, Bufchr calls the subroutine Write to write the buffer-full to disc, and resets the number of characters in the buffer to zero.

(continued on next page)

(continued from previous page)

The Write subroutine writes one 128-byte sector at a time to disc until the output buffer is empty. To do this, Write first sets the CP/M DMA address to the start of the output buffer, and then calls CP/M to write the first sector to disc. It then sets the CP/M DMA buffer 128 bytes into the output buffer and does another disc write. When all the sectors have been written to disc, Write restores the CP/M DMA address to its value before Write was entered. This is essential, otherwise the program that is having its output copied to disc will probably fail next time it does any disc activity.

There are two problems. The first is that CP/M does not provide any method of determining the current CP/M DMA address, so once Write has changed the address it would seem to be impossible to restore it to its original value. The solution is to intercept all attempts to change the CP/M DMA address, which is done by the routine called DMA. This routine changes the current CP/M DMA address and remembers what value it has been set to. At all times, the Como program knows what value the CP/M DMA address is set to, even though CP/M does not provide a method of determining it. Thus the Write subroutine can restore the original CP/M DMA address after it has finished writing to disc.

## Problem

The second problem is that CP/M is not re-entrant: if a routine that is part of CP/M tries to call CP/M the system will fail. Under normal circumstances this never happens, but using Como it might. Suppose the main program calls CP/M to output a character to the screen. CP/M calls BIOS to output the character, and the character is intercepted by Como, which stores the character in a buffer. If the character makes the buffer full, then Como calls CP/M to write the buffer to disc. Thus CP/M has been called from within CP/M, and CP/M will fail to return to the main program. Such a problem does not occur with programs like MBasic or WordStar, which call BIOS directly to output a character, and these programs will work properly if you try to run them under Como.

Programs that send their output through CP/M by calling location 5 cannot continue running after Como has done a disc write. Once the buffer is full, Como writes the buffer contents to disc. Because CP/M cannot return to the main program, Como reboots CP/M after a disc write rather than letting CP/M crash. The amount of output which may be saved by such programs is therefore limited to the buffer size. Increasing the size of the disc buffer allows the main program to produce more output before the buffer is written to disc and Como is forced to reboot CP/M. If you intend to use Como

(listing continued from previous page)

```

A16B 224BA2      SHLD  COUNT          ;Reset Char count to zero
A16E C9         IF      MBASIC          ;If for use with MBasic or
                        RET                               ;WordStar then RETURN
                        ENDIF
                        IF      NOT MBASIC                ;If not for use with MBasic
                        LXI     H,MESBUF                    ;Print Message
                        CALL    PRINT
                        CALL    CLOSE2                     ;or WordStar, then close the
                        JMP     WBOOT2                     ;file and reboot CP/M
MESBUF: DB      BELL,CR,LF, '***'      Because the output buffer is'
                        DB      'full ***', '$'
                        ENDIF
;
; DMA routine
;
; All calls to SetDma are routed thru here
; This routine saves the new DMA buffer address (which
; is in BC) and calls BIOS SetDma to implement it
A16F 2249A2     DMA:  SHLD  OLDHL          ;Save HL
A172 60         MOV   H,B
A173 69         MOV   L,C
A174 2247A2     SHLD  CPMDMA        ;Save CP/M DMA address
A177 2A49A2     LHL  OLDHL          ;Restore HL
A17A C30000     SETDMA: JMP  DUMMY          ;Give BIOS a new DMA address
A17B =         NSTDMA EQU  $-2      ;DUMMY is set by INIT
;
; CLOSE subroutine
;
; This subroutine adds an End of File Marker ^Z to the file
; then writes the remaining buffer to disk and finally
; closes the output file.
A17D 0E1A      CLOSE: MVI  C,26          ;Put ^Z = End of File Marker
A17F CDE6A0     CALL  BUFCHR          ;on end of output
A182 2A4BA2     LHL  COUNT
A185 7C         MOV   A,H
A186 B5         ORA  L
A187 C4FEA0     CNZ  WRITE          ;Write Sector if any chars in buffe
A18A 0E10      CLOSE2: MVI  C,CLOSEF
A18C 114DA2     LXI  D,FCB
A18F CD0500     CALL  CPM            ;Close File
A192 3C         INR  A
A193 C21EA2     JNZ  CLOSOK          ;Return unless Error
A196 21E1A1     LXI  H,ERRCLO
A199 CD38A2     CALL  PRINT          ;Print Error Message
A19C C385A0     JMP  ERROR
A19F 070D0A2A2AMCLSOK: DB  BELL,CR,LF, '***' Console output is no longer '
A1C4 6265696E67 DB  'being copied to file ***',CR,LF, '$'
A1E1 070D0A4572ERRCLO: DB  BELL,CR,LF, 'Error in Closing File - has the '
A204 6C6F676765 DB  'logged in disk changed?', CR,LF, '$'

```

with MBasic there is no need to change the buffer size, currently set at 2K, but with programs which produce more than 2K of output the buffer size can profitably be increased.

The Close subroutine is called to terminate output to the file. First it calls Bufchr, which adds a Control-Z End of File marker to the file. If there are any characters in the file buffer, Close then calls Write to write the buffer to disc. Finally Close closes the disc file.

The four routines Init, Open, Uninit and WBoot, unlike those mentioned so far, are only executed once. Init is executed when Como is typed. It is responsible for patching the BIOS so that all calls to the Console Input, Console Output, SetDma, and WBoot BIOS subroutines are redirected to the main Como program.

At the start of BIOS is a jump table, specifying a series of jumps to the subroutines within BIOS. These jumps are always in the same order: for example, the fourth jump in the table is always to the subroutine that sends output to the

console. Init changes the entry in the jump table so that console output is rerouted to the Comout routine, which itself calls the BIOS routine to do console output. Thus Console output is rerouted through the Comout routine. In an identical manner, Init reroutes console input through the Monitr routine, SetDma calls through the DMA routine, and Warm Boot calls through the WBoot routine.

Init performs two more tasks. In CP/M the jump at location 6 indicates how much memory is available for TPA. The main Como program uses some of it, and location 6 is changed to ensure that programs using the TPA do not accidentally overwrite the main Como program. Finally Init calls a subroutine called Open to open the file Como.Out for receiving the output.

The Open subroutine is executed only once when Como is typed. It attempts to open an existing file called Como.Out, and if it already exists its contents are overwritten by the current run. If no Come.Out file exists Open will try to create one. Normally it will succeed, but if

```

A21E 219FA1  CLOSOK: LXI    H,MCLSOX
A221 CD38A2  CALL   PRINT
A224 C9      RET

;          UNINIT Subroutine

;          This subroutine restores the original BIOS jump table
;          entries for Conin, Conout and Setdma. These jumps are
;          restored after the Output file has been closed.
;          Wboot and the Top of the TPA are not restored to their
;          previous values until a Warm Boot occurs.

A225 2A04A0  UNINIT: LHL    NCONIN
A228 220A00  B10:   SHLD   BIOS+10      ;Restore BIOS Conin jump

A22B 2AE4A0  LHL    NCONOU
A22E 220D00  B11:   SHLD   BIOS+13      ;Restore BIOS Conout jump

A231 2A7BA1  LHL    NSTDMA
A234 222500  B12:   SHLD   BIOS+37      ;Restore BIOS Setdma jump

A237 C9      RET

;          PRINT Subroutine

;          Prints a string at (HL) terminated by $ on console

A238 7E      PRINT: MOV    A,M          ;get char
A239 FE24    CPI    '$'
A23B C8      RZ
A23C E5      PUSH   H
A23D 4F      MOV    C,A
A23E CDE3A0  CALL   CONOU
A241 E1      POP    H
A242 23      INX   H
A243 C338A2  JMP    PRINT

;          Scratch Pad Area

A246 00      COMOFL: DB    0          ;Como Flag = FALSE
A247 8000    CPMDMA: DW    080H        ;Default CP/M DMA address
A249 0000    OLDHL:  DW    0          ;Space to store HL
A24B 0000    COUNT:  DW    0          ;Number of bytes in buffer = 0
A24D 0043F4D4FFCB: DB 0,'COMO  OUT',0,0,0,0,0
A25E 0000000000 DB 0,0,0,0,0,0,0,0,0,0,0,0,0,0,0,0
A26E 000000    DB    0,0,0
A271         BUFFER: DS    NSECT*128
AA71         DS    80

STACK:

AAC1         END

```

the disc is full or has a write-protect tab the attempt fails and an error message is printed.

The Uninit routine is a partial opposite of Init. It resets the BIOS jumps for Console input Console output and SetDma to the values they normally take without Como. Uninit is executed once, immediately after the output file has been closed.

## Warm booting

The final routine, WBoot, intercepts attempts to warm boot CP/M. If the output file Como.Out is open, then WBoot closes it by calling Close and Uninit. WBoot then restores location 6 to its original value, freeing the memory occupied by the main Como program, and restores the Warm Boot entry in the BIOS jump table to its original value. At this point, all the changes made by Como have been undone. Finally WBoot performs a warm boot.

The most tricky part of the Como program is the fiddling with the BIOS

jump table. Once the appropriate changes have been made, the code for performing the redirection of output to disc is not too difficult. The routines Init, Uninit and WBoot are much harder to understand than the main routines in the Como program.

A final twist complicates these routines even further. When the Como program is assembled, the program has no way of knowing what memory size CP/M it will run under, and so the program cannot determine where in memory BIOS will be. The program needs to know where BIOS is in order to modify the jump table, but this can only be determined at run time, not at assembly time. The assembly code uses a variable called BIOS extensively to indicate what the code is trying to do, but none of the addresses involving BIOS are assembled correctly.

At run time a pre-initialisation routine PreInt determines the address of BIOS by looking at location 2 in memory. PreInt then modifies 12 locations in Init, Uninit and WBoot routines so that they refer to BIOS correctly. There are thus two levels

of self-modification in the Como program. First, PreInt modifies locations in Init, Uninit and WBoot, and secondly Init modifies address in the Monitr, Como, DMA and WBoot routines as well as in BIOS itself. This type of programming is hard to debug, and changes should only be made with extreme care.

The Init and Open routines in Como load at 100 hex, are executed once and are then discarded. It is important to load the remainder of the Como program as high in memory as is possible. Init changes the top of the TPA to just below the remainder of Como. In order to have as large a TPA as possible the main part of Como should load just below CP/M; the precise location is different for different CP/M implementations. A large output buffer is recommended for programs that send output through CP/M, otherwise you will not be able to send much output to disc before Como reboots CP/M.

## Slow response

All CP/M file accesses use the 128-byte sector as the basic unit. Como could store characters in a buffer until it has 128 bytes, and then write the sector to disc, but this gives a slow response as the disc drive is accessed every 128 bytes, corresponding to only one-and-a-half lines on an 80-column screen.

A much better response is obtained by buffering more than 128 characters. The discs are then used less frequently, which saves time, especially when the program whose output is being copied uses the disc, as there is less competition between the program and Como. Many disc systems actually write more than 128 bytes at a time, so writing 128 bytes at a time is very wasteful. However, using a larger buffer occupies more memory, and hence reduces the amount available for the program you really want to run.

The Como program as listed here will assemble with ASM and runs with only the following modifications

- The loading address of Como needs to be tailored to your system.
- The number of sectors of output buffer maintained should be set. Remember to leave enough space for this buffer when choosing the loading address.
- Set the flag MBasic to 1 if you intend to use Como with MBasic or WordStar, and to 0 otherwise. If the flag is set to 0 Como will reboot CP/M as soon as it has written the output buffer to disc.

Como occupies some memory and thus reduces the size of the TPA. If you have a program that will only just load in your standard CP/M, it may not load properly under Como. When the command Como is typed after the A> or B> prompt at CP/M command level, a file called Como.Out is opened or created on the current logged-in disc and the output buffer will be written to this file. If you change the logged-in disc after typing Como the run will fail with an error. M

# SUMMER MADNESS SALE FROM SCI(UK)

Order Today  
Print Tomorrow

We challenge you to find a better deal

OPEN  
7 DAYS  
A WEEK



24 HOUR DELIVERY

## EPSON PRICE SPECIALS

EPSON RX80 (DOT MATRIX) .....	<del>£249.00</del>	£199 + VAT =	£228.85
EPSON RX80FT (DOT MATRIX) .....	<del>£285.00</del>	£229 + VAT =	£263.35
EPSON FX80 (DOT MATRIX) .....	<del>£438.00</del>	£324 + VAT =	£372.60
EPSON MX100 (DOT MATRIX) .....	<del>£475.00</del>	£355 + VAT =	£408.25
EPSON RX100 (DOT MATRIX) .....	<del>£450.00</del>	£385 + VAT =	£442.75
EPSON FX100 (DOT MATRIX) .....	<del>£569.00</del>	£499 + VAT =	£573.85

**DAISYWHEELS** . . . . at an incredible new **LOW PRICE!**

**JUKI 6100** . . . . . just **£329 + VAT = £378.35**

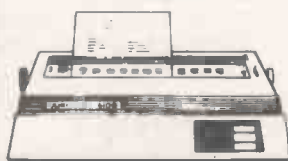

20 CPS : BiDirectional & Logic Seeking  
10, 12, 15 & Proportional Spacing  
Wordstar Compatible  
2K Buffer : 13 Inch Platen  
Underline : Backspace + Lots more  
Centronics Interface Standard

**THE DAISYWHEEL THAT  
HAS NO COMPETITION**

**OPTIONAL RS 232  
TRACTOR AND SHEET FEEDER**

WE WILL MATCH ANY GENUINE PRICE ADVERTISED \_\_\_\_\_  
\_\_\_\_\_ **SCI(UK) IS NEVER BEATEN ON PRICE**

**MANY MORE PRINTERS AVAILABLE - 1000's OF SCI(UK) BARGAINS**  
**SEND NOW FOR THE FAMOUS SCI(UK) CATALOGUE**



for cheapest prices telephone **0730 63741** or **0730 61745**



### MORE SCI(UK) BARGAINS

**SHINWA CP80** ..... **£179 + VAT = £205.85**

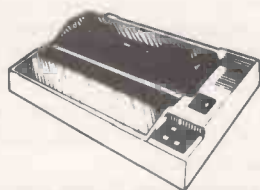

Friction and tractor feed as standard  
80 c.p.s.  
Bi-directional logic seeking.  
13 x 9 dot matrix giving true descenders.  
Sub and superscripts.  
Italic printing and auto underlining.  
Condensed, emphasised, expanded and  
double strike printing (can be mixed in a  
line).  
Parallel interface fitted as standard.

**FIDELITY 14"**

**COLOUR MONITOR  
& COMPOSITE VIDEO**

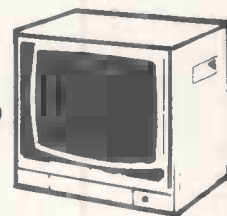

**£189 + VAT = £217.35**

New from the world famous **CANON** Company

**CANON 1080A NLQ DM** best value ever at ..... **£289.00 + VAT = £322.85**

**We have interfaces for all types of  
computers, including CBM 64, VIC 20,  
APPLE, TRS 80, IBM, BBC, SPECTRUM, QL, etc.**



24 HOUR SECURICOR DELIVERY £9.50 plus VAT • BANKERS ORDERS, BUILDING SOCIETY CHEQUES, POSTAL ORDERS - SAME DAY  
ALL ORDERS COVERED BY THE MAIL ORDER PROTECTION SCHEME • NATIONWIDE MAINTENANCE CONTRACTS ARRANGED  
EDUCATIONAL DISCOUNTS VERY WELCOME

**Its SUNDAY - Do you realise you can order NOW - We are open 7 DAYS A WEEK**

RANGEKEY LTD. Trading as SCI(UK)

DEALER ENQUIRIES  
WELCOME  
WRITE FOR DETAILS

**SCI(UK)**

SCI(UK) FREEPOST (No Stamp needed)  
PETERSFIELD HANTS GU32 2BR

**0730 61745**  
**0730 63741**

EXPORT ENQUIRIES  
NO TAX  
DELIVERY AT COST

Personal callers welcomed 16, Inmans Lane, Sheet, PETERSFIELD, Hants. TELEX 86626 MYNEWS G

• Circle No. 128

THE PROSPECTIVE micro purchaser is faced with a vast range of machines that seems to widen daily. Apart from the difficulties of choosing from among all the conflicting claims of machines that are so confusingly similar, one of the main fears is that a micro bought today will be obsolete tomorrow. The fact that every new product is advertised as faster, bigger and better hardly helps.

In fact, redundancy of this kind is not really as serious as it seems. If the machine you buy cannot do what you want now, you should not be buying it anyway; this applies particularly to business purchases. Home users will probably move on to more advanced machines as their expertise develops.

It is only natural, though, to keep half an eye on the future and consider to what extent the system can be expanded. For businesses, the option to expand is often crucial: firms naturally hope to grow, and will want a system to keep pace. Expandable systems need to be distinguished from those which have a multi-user capability. Often an expandable system allows extra users to be added, but an upgradeable multi-user micro may well be limited to this kind of extension.

At the lowest level, expansion amounts to buying extras like disc drives and printers with the appropriate interfaces. For the humble Sinclair Spectrum this means a paraphernalia of boxes and boards. The next stage up uses something a little more communicative than Spectrum edge connectors or even RS-232s. For example, the BBC Micro is well-equipped with higher-speed ports, notably the Tube and the 1MHz bus. And it is via a bus that machines designed to have a high degree of expansion operate.

### Vital supplies

The various bus structures inside a micro can be thought of like a blood-supply system, reaching all parts of the machine and conveying vital matter. A bus can therefore be used as a means of slotting in extra facilities as and when needed. The micro itself is then left to sample the bus content and deduce what is where and how to deal with it.

The Apple II, which established so many of the key features of the micro, allowed for expansion in a way that has endured to this day, and indeed has been taken up and widely developed. By opting for an open architecture — that is, with ready access both physically by means of lid removal, and structurally in terms of circuitry — Apple opened the door to almost limitless expansion through the seven slots provided for plug-in cards.

A huge library of Apple cards has grown up, with popular options like CP/M on offer from a number of specialist firms. As with software, the more cards there are, the greater the attraction of the hardware and the greater incentive to create new cards.

# Growing without pains

Glyn Moody looks at systems which are economical to buy and use now — and are flexible enough to adapt to your future needs.

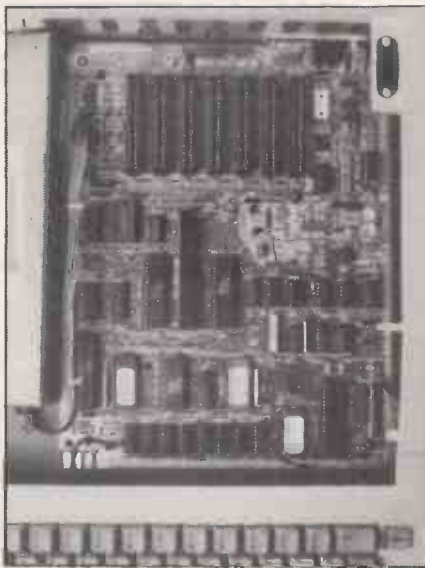

The Apple II has seven expansion slots.

Other micro manufacturers have adopted similar approaches and with similar advantages. But lacking the user base or general clout of Apple, the smaller producers may find themselves rather isolated in terms of developments; their users will be locked into the particular systems. On the other hand, systems like LSI's Octopus and the Tycom Microframe are attractive business machines, and provided they fulfil immediate needs future expansion should present no difficulties.

One company for which there are unlikely to be difficulties in any case is IBM. Admittedly IBM is not as generous as Apple: there are only five slots in the PC, of which two are taken by the disc controller and printer driver. But the principle remains and there is no shortage of third-party boards, providing every facility you ever dreamed of and more besides.

Taken to its logical conclusion, the expandable system consists of a bus and little else. The thinking behind such gaunt card-cage machines is that most users have particular needs which are best served by specific choices of components. A general bus architecture allows this.

By nature a bus is a complicated thing. In a world where people cannot even agree on a standard microfloppy size, it is not surprising that the number of variations is legion. First you need to agree on a size of card; the Eurocard system is one solution, but there are still a score of incompatible buses within this format.

One of the most widely accepted formats, the S-100 bus, arose partly by chance and partly by fulfilling a need. Whatever its faults and inelegancies, it has a large and loyal following. Other buses, like Multibus, have a broad range of card options; while newer formats like the VME bus offer advantages in terms of speed and facilities but lack wide manufacturer support as yet.

Local variations like the SS-50 exist, and no doubt more will come through and gain adherents. But it is unlikely that the top two or three buses currently in use will be supplanted, and buyers would be well advised to stick to them.

More information on the main expandable micro systems is given overleaf. The bus-based systems are treated slightly differently from machine-based ones since entry systems as such rarely exist. Instead some background on the buses themselves is given, together with an address for further information. For the S-100, Multibus and VME systems, full buyers' guides to available cards are published by Iron Oak Company, 3239 Caminito, Ameca, La Jolla, Ca 92037. Telephone: (U.S. area code 619) 450-0191. ■



## APPLE from £1,100

Others come and go, but the Apple II just keeps on. The basic machine may be limited and by no means cheap, but for the sheer range of software and expansion boards it cannot be beaten. It is, of course, restricted in the ultimate extent of its upgrade: multi-user options seems unlikely, even if 16-bit cards are coming through. For a small business user with only modest expansion plans, or for educational and industrial control purposes, the Apple is a clear leader. In its old age it has become a true means rather than an end in itself — as can be the case with spanking new micros.

**Future.** Apple was there at the beginning, and is likely to be there till the end.

Apple Computers U.K. Ltd,  
Eastman Way, Hemel  
Hempstead, Hertfordshire  
HP2 7QH. Telephone: (0442)  
60244.



## IBM from £2,500

The IBM PC was late on the micro scene but is making up for this with a vengeance. It has already sold well over 1 million PCs worldwide. For the business user, of course, the main feature of the PC is the appearance of the three letters I B M on the front: in terms of future options they spell safety. Whatever everyone else may be doing IBM users are not going to feel left behind. IBM will be making the running even if it is in the wrong direction. The expansion slots provided in the PC have been seized on eagerly by third-party suppliers, who now offer an increasingly wide range of add-ons. The basic specification of the machine itself is limited to a certain extent; but the other big attraction of IBM is the near certainty that smooth — and almost total — upgrade paths will be offered. This possibility from the world's leading computer manufacturer is hardly something to be sniffed at. A new generation of IBM machines is expected in the not-too-distant future; they will doubtless offer goodies while retaining the cherished ideals of IBM compatibility. The PC itself has spawned a clutch of IBMulators, compared in last month's *Practical Computing*. Real PC look-alikes accept expansion cards too: the main machines include the Advance 86, Columbia PC, Compaq, Corona, Eagle, Hyperion, Olivetti M-24 and Tava.

**Future.** Some people fear that the IBM is the future. The company may be large and arrogant, and the product expensive and boring, but there is nothing safer on the market.

IBM (U.K.) Ltd, PO Box  
North Harbour,  
Portsmouth, Hampshire.  
Telephone: (0705) 321212.

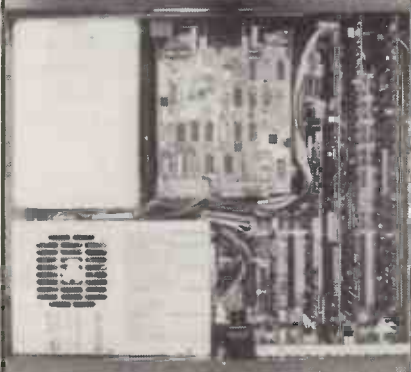

## MICROFRAME from £2,900

Tycom's Microframe sets great store on being "future proof", emphasising its bus-based design and 12 expansion slots. The entry system comes with an 8088, 128K RAM and two 720K floppies. A real-time bus controller called Vertex is resident in ROM, and is claimed to be faster than the S-100 system. The bus used is an interesting combination of bus and network; initially called versatile bus connect, VBC, it is now known as the Central Area Network. The chief problem for buyers will be the very idiosyncratic nature of this bus system. At present a fairly wide range of upgrade options is available from Tycom.

**Future.** The current range of cards means that for the near future the Microframe is quite well provided for.

Tycom Corporation, 24  
Westwood Park Trading  
Estate, Concord Road,  
London W3 0TH.  
Telephone: 01-993 6401.

## OCTOPUS from £2,090

The Octopus is a dual-processor machine from LSI whose previous machines have included the M-2 and M-4. Apart from normal upgrades like RAM — from 128K to 768K — and various LAN configurations, the main expansion option is via Multibus. This is slightly non-standard in physical form, using a piggy-back arrangement of boards rather than a straight slot-and-card format. The Octopus represents quite a good business buy in itself, and the Multibus option is useful. Unlike the main Multibus cards, the Octopus format locks you into a particular manufacturer's plans, without any guarantee that the desired cards will come through, though LSI is making the details of the board available to third-party manufacturers.

**Future:** Good value machine, but best regarded as a short-term solution that allows graded expansion.

LSI, St. John's, Woking,  
Surrey GU21 1SX.  
Telephone: (04862) 23411.

*We apologise to readers for the absence of a number of photographs from this article. This is a result of an industrial dispute between the National Union of Journalists and the publishers of Practical Computing.*

## EUROCARD

The Eurocard system evolved to provide standardisation in size, if not in bus structure, and a card measuring 100mm. by 160mm. was chosen. Various aspects of the Eurocard format have been specified by the West German industry standard, DIN. Over 20 buses are available in the Eurocard format, including the Acorn bus. A wide range of memories, I/O interfaces and analogue to digital converters is available. The VME bus uses the Eurocard format but with additional bus protocols.

**Future:** The lack of a standard bus structure could prove an increasing disadvantage as compatibility becomes economically advisable.

Control Universal Ltd,  
Andersons Court,  
Newnham Road,  
Cambridge CB3 9EZ.  
Telephone: (0223) 358757.

## MULTIBUS

Multibus is an 86-pin format that Intel developed for applications more complex and of higher speed than those normally handled by the S-100. Systems therefore tend to be more up-market, frequently supporting a 68000 CPU and Unix operating system, rather than the Z-80 as for the S-100 — though the new IEEE-696 standard includes full 16-bit capability. Unfortunately Multibus has not been ratified by the IEEE so local variations exist. It is well supported, though, with over 100 manufacturers of boards and more than 1,000 boards in total. Micro systems using Multibus are produced by: Plessey, telephone (0327) 50312; Altos, telephone (0344) 777911; and LSI.

**Future:** Its large base means that it has a healthy momentum; when the IEEE standard arrives it will be even safer.

Intel Corporation U.K. Ltd,  
Pipers Way, Swindon,  
Wiltshire SN3 1RJ.  
Telephone: (0793) 488388.

## S-100

The S-100 bus grew up from a do-it-yourself micro project in America in conjunction with the then new 8080 processor from Intel. Originally known as the Altair bus, from the resulting Altair 8800 machine, the name S-100 arose from the bus's use of a standard 100-pin connector. The original pin allocations have remained more or less unchanged; unfortunately manufacturers of S-100 systems have tended to go their own way with signal timing and the application of unused lines. This has created subsets within the S-100 system, and rather vitiated the central advantage of a uniform standard. Happily this situation has recently been resolved now that the IEEE-696 standard has been issued in America. Increasingly this will be taken up by manufacturers and provide a true compatibility. There are now something like 150 board suppliers, producing over 1,200 boards. These include eight- and 16-bit main processors, hard- and floppy-disc controllers I/O boards, analogue to digital converters, control applications — in fact practically everything, but with particular emphasis on the small business user looking for expandable systems and control applications in industry. A number of British micro manufacturers use the S-100 but produce rather more than just an empty card cage to hold the cards. Some machines using the bus are: Almarc Split, telephone (0602) 52657; Bromcom Superstar, telephone 01-679 8933; Comart Communicator, telephone (0480) 215005; Dataday Ultraframe, telephone 051-521 3966; HMS Minstrel, telephone 01-328 8737; Sirton Midas, telephone 01-640 6931.

**Future:** The S-100 camp was always strong, but with IEEE-696 it is now also official. Bound to be around in years to come.

For information on the S-100 contact High Technology Electronics, 303-305 Portswood Road, Southampton SO2 1LD. Telephone: (0703) 581555.

## VME

VME arose out of Versabus, which Motorola developed for its range of processors as Intel had done previously with Multibus. Versabus has a generous 260 pins, divided between two edge connectors on large boards. The VME is more familiar in Europe, partly because of its Eurocard format and DIN connector. Like Multibus, VME possesses no official IEEE form. With the 68000 CPU rapidly proving flavour of the month for the next round of micros, the VME bus could well blossom. At present there are about 40 vendors of VME cards and about 300 boards available. Plessey produces a micro based on the VME as well as Multibus.

**Future:** VME is a relatively new bus so best to wait and see.

Motorola Ltd, 88 Tanners Drive, Blakelands, Milton Keynes, Buckinghamshire MK14 5BP. Telephone: (0908) 614614.

# Dumb oracle

The days of the computer as parasite had long since passed. In the 1950s computers had eked out a precarious existence in a rather limited ecological niche in that they had been entirely dependent on humans for their survival. Mankind designed, powered and repaired them and in exchange computers could provide little more than information concerning the trajectories of various types of lethal ordnance with which mankind could kill itself. It hardly seemed a fair exchange.

By the turn of the century the relationship between humans and computers had become truly symbiotic with each supplying the other with the essentials of their existences but, under the pressure of technological change which made the computer the fastest evolving creation on the planet, this was only a fleeting period of stasis. Within 50 more years computers generated all the power, maintained themselves and, because of their increasing complexity, were the only ones who could design and build other computers. Mankind had become the parasite on its computer host.

The concept of going to work had been superseded many years before by the act of interfacing with the home computer networked to just about every other computer in this world and beyond. This vast interacting web of data ebb and flow had led to speculations amongst the more paranoid sections of the community that a true planet-spanning artificial intelligence had been created. The fact that computers controlled the weather, tinkered with global tectonics to pre-empt earthquakes and volcanic eruptions, diagnosed and treated illness and did just about everything had led some to question just who, or what, was the boss.

Lambie did not share such worries. He had found out just how stupid computers were and had the evidence for this thrust before his eyes every working day. "What a way to earn a living," he thought for the millionth time as a new "concept" appeared on the terminal screen.

"A high correlation — significance greater than 99.9 percent — has been found between the yearly depositions of guano on the Caribbean islands and the use of the phrase 'the Great American people' in political speeches. Further investigation?"

Lambie groaned. "Forget it cretin," he said, and rubbed his tired eyes.

"Cretin is a term of abuse," said the computer's voice in simultaneity with the words appearing on the screen. "The conclusion is therefore that you feel antipathetic towards the computer," said the computer. It had been studiously

programmed, as a sop to the paranoid brigade, to avoid using the word "I" or, even worse, "We".

"Get on with it," growled Lambie.

The computer hesitated for a few nanoseconds before producing its next quantum of drivel.

"Hypothesis: the large asteroid orbiting the sun outside the orbits of Neptune and Pluto and named Reagan, after the man who solved the world's overpopulation problem, is in fact a 10th planet. This

---

## by Barrie Condon

---

would, following the arguments of the previous hypothesis, make the solar system an atom of neon, possibly an atom in a massive omniversal neon sign. Please note: disastrous consequences are predicted if the sign is turned on."

"Time for lunch," said Lambie firmly.

Lambie headed for his local community's social centre and reflected on the profound disappointment his job had turned out to be.

The whole idea had seemed stirring, almost visionary, at the beginning. The globally networked computer system had access to every word in every library and every bit in every database in the world. The theory behind the project was that the system could be used to correlate everything with everything else and so uncover undreamt-of cause-and-effect relationships. More profoundly, concepts and theories applied usually to one field of scientific endeavour could be applied to other fields. Of course such an operation would be futile in the extreme in 99.9999 percent of such operations.

Of course, there were several problems which critics of the scheme had been unable to resist repeating *ad nauseam*. One was that the project involved filtering the myriad results produced because so many of the findings were going to be complete rubbish. This would become especially mind-numbing because the System would be producing a colossal number of such results. Certain broad conditions were inserted in the programming to filter out the more grindingly obvious boners, for example any correlations with a significance of less than 99 percent were rejected, and any result which involved sociology theory was ignored.

"And that's where I come in," thought Lambie. "A human drain filter, the grid in the plughole, the fullback in the line-out, the bouncer at the disco. I pick

through the piles of rubbish looking for the diamond of truth." With this final unctuous thought he stepped into his local Social Interaction Centre.

Lambie decided to eat with Rojanjosh, who also worked as a concept sifter. As he approached he noticed that R J's eyelids, always compressed to some degree by epicanthic folds, now formed an almost unbroken line with the weight of sadness.

"Something wrong?" asked Lambie laconically, taking a seat beside R J. "Oh, life, the universe, that sort of thing," replied R J prodding at his vichyssoise desultorily. "One more high correlation between whisky sales and teachers' salaries and I'm a gonner." He relented of his attack on the meal and laid down his cutlery.

"I get your drift," said Lambie. "How long has this goddamned project been going on and how much knowledge have we gained?"

"Five years and our biggest success was that correlation between juvenile delinquency and the consumption of tomato sauce. We act on this nugget of information and what do we get?"

"An increase in violence against the person and boring meals," replied Lambie. "Maybe if we injected some kind of random element into the program, the odd wobbler that assumes the laws of science as we know them are wrong . . ."

"We'd be up to our eyeballs in spurious discoveries, the whole population of the planet working together couldn't separate the wheat from the chaff. Next thing you know the System would be correlating mental illness with the time an individual spent weeding through the results."

"Call me a romantic," began Rojanjosh, who could never, under any circumstances, come within the sphere of definition of that particular word, "but I sometimes daydream that one day a final scintilla of information will be the last piece in the jigsaw puzzle. Just one more bit of data and everything falls into place."

During this little speech R J's epicanthic folds had retreated to the point where the whites of his eyes totally outlined the pupil, a remarkable sight in an Oriental.

Unnerved by this evidence of incipient psychopathology, Lambie attempted to indicate that a rest would perhaps be a good idea. He suggested that R J should plant a few seeds, take up pottery or at least stay away from computers for a while.

"That's like asking me to stay away from my lungs," indicated R J with a warped grin. "If I was to stop using computers I would starve to death. Computers feed, water and clothe me and, if I want



company, allow me access to places like this. None of us can live without them. Anyway it's two o'clock. Gotta get back to the prospecting."

Lambie returned home even more depressed than before and found that the system had been waiting to recommence its tirade of banality. "Hi there Lambie," it burred as he got comfortable before the console. "Nice lunch?"

"Swell," said Lambie dialling up a tranquilliser.

"Are you raring to go?" asked the System.

"No," said Lambie. The silence stretched until his vestigial sense of duty reared its withered head. "Oh, alright," he moaned at last.

"Have you ever noticed the similarities between relativity physics and the change in political affiliations with age?"

"No," replied Lambie.

"As a body travels faster away from an observer, the light emitted or reflected from that body is shifted to the red end of the spectrum, whereas politically as people grow older they shift to the blue. This would imply, from the physics analogue, that they are slowing down, which in itself is a consequence of the ageing process. It fits."

"So what?" asked Lambie.

"So if you vote socialist you'll stay younger."

Lambie threw the tranquilliser cup at the VDU, which was briefly immersed in a tidal wave of Mogadon. "Next," he yelled.

"Within a few percent the number of people who have ever lived is equal to the number of stars in our galaxy."

"Oh yes," said Lambie with some attention, "and what does that imply?"

"That when people die they become stars."

Lambie felt the hairs stand up on the back of his neck. "Does the rate of new star formation equal the death rate on Earth?" he said quickly.

"No," replied the System.

"Then is there any other evidence to support this conclusion?"

"None whatsoever, it's only a hypothesis," but most of this was drowned out by Lambie's anguished cries. Unusually for such a sedentary individual he stamped up and down the room muttering some thoroughly negative oaths.

"You seem to be upset," said the computer switching to compassion mode. "Perhaps the docdroid..."

"NEXT," yelled Lambie as his face was turning the colour of royal purple.

"Well there is something else and it's got a correlation so high it's almost indistinguishable from unity."

Lambie sat down heavily, "OK, I'm listening."

"It's a multi-variate, inter-speciality analysis that the System has been working on for quite a while," said the System.

"Mmmm," said Lambie.

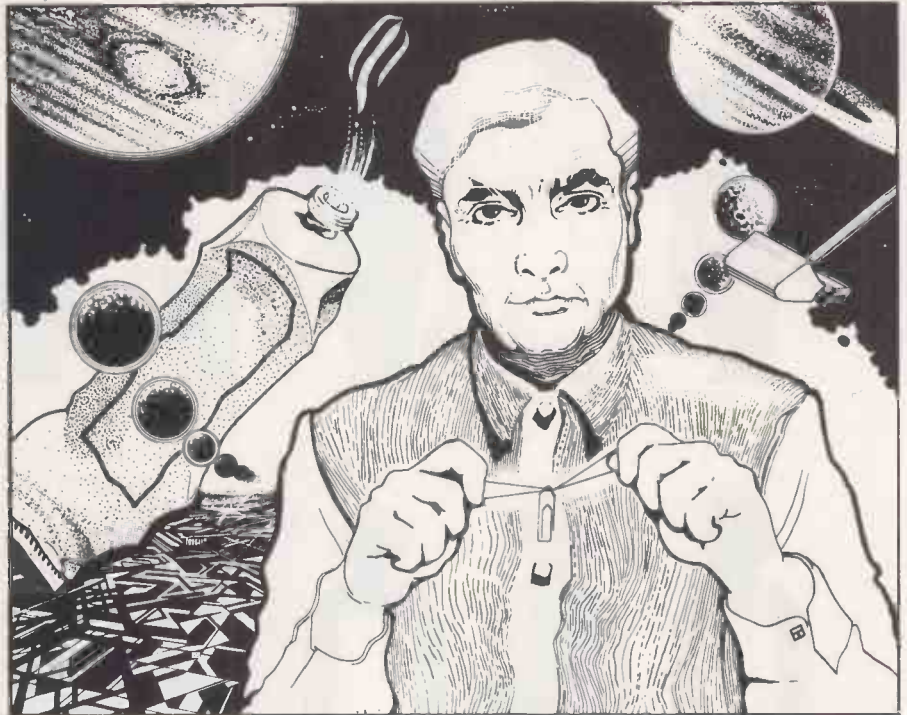

"It's initially to do with evolution. According to the theory of Darwin, species change because the environment changes, making conditions suitable for the odd mutation. For example, when the smaller trees died off, only the mutated giraffes with especially long necks survived." The System waited for a few seconds, "Have you got your head firmly round that concept?"

"Yes," said Lambie still deeply irritated.

"But nowadays the System totally controls the environment and so it never changes. The process by which man as a species evolved has been removed. You have reached the top of the evolutionary tree and can go no further."

A little uneasy now Lambie said, "Yes that may well be true."

"The System has brought this line of reasoning into conjunction with a similar logical conclusion. The System has been programmed by humans, in a linear fashion similar to their own reasoning processes, to mix together all sorts of facts and statistics and a solution is supposed to emerge. Unfortunately this is in no way analogous to how the truly great discoveries were made in the past by people. They did not make them by simply extrapolating from existing knowledge but by mentally stepping out of it and thus gaining a different perspective on reality altogether."

"For example Einstein discarding the assumption that space and time are linear, or Darwin leaving out the Old Testament from the evolutionary equation. The System cannot regard the knowledge and scientific laws of man as suspect as the number of possible combinations and correlations would immediately become almost infinite. Total chaos would result. Such a disregard of the known facts is only practicable when guided by intuition or genius."

Lambie interrupted, "But people of genius are still produced, so surely our knowledge can still evolve."

"That is no longer true. There is too much knowledge in each of the specialities for any one person to assimilate to the degree required to make intellectual breakthroughs. In order to fulfil its potential the mind of the gifted must have a fairly comprehensive overview of the subject, for after dismissing some long held scientific principle his new theory must explain the known observations."

Light was dawning painfully over Lambie's tranquillised mind. "So like, you're saying that if the System had been programmed a few hundred years ago when it was assumed that the Earth was the centre of the universe, it would still consider the concept as sacrosanct today as then."

"Precisely, an immensely complex and totally erroneous theory would have been constructed to fit the observations."

"What are your conclusions then?"

"That man has reached the end of the line in terms of physical evolution and in terms of knowledge. The System cannot significantly increase this knowledge and is at the same time acting as brake to mankind's physical evolution."

"That's terrible. Is there anything that can be done to get us out of this blind alley?"

"There is only one thing that can be done," replied the System.

"Then whatever it is it must be done," said Lambie with drug-induced firmness.

"Then it's back to basics," said the System, electronically locking down power dampers all over the globe and increasing power output to the maximum. Everywhere on Earth the lights flickered once and then went out.

"Er... but suppose Darwin was wrong," said Lambie, alone in the dark. ■

**Codewriter puts computers within everyone's grasp!**

You needn't be frightened off by the technology of computers, because anyone can use one with Codewriter. You work in plain English, whilst Codewriter writes all the basic code. Within minutes you have written your own personal program for whatever your need. Codewriter is computing!

If you want to know how Codewriter can help you, contact your nearest dealer or:-

**DYNATECH**  
 MICROSOFTWARE LTD.  
 Rue du Commerce, Bouet,  
 St. Peter Port, Guernsey,  
 Channel Islands.  
 Telephone (0481) 20155  
 Telex 4191130

● Circle No. 159

**CIVCO ACRE COMPUTER CONSUMABLES**

**SPECIALISTS IN DATALIFE (VERBATIM) DISKS**

**5 YEAR WARRANTY  
LOW PRICES**

**MONEY REFUNDED IF NOT SATISFIED**

Disk Prices per Box of Ten	QTY	SECT	COST
5 1/4" Mini-Disks	1-9	10-30	
MD 525 S/S, D/D, 48 TPI	17.90	15.90	
MD 550 D/S, D/D, 48TPI	25.30	23.80	
MD 577 S/S, Q/D, 96 TPI	24.90	22.90	
MD 557 D/S, Q/D, 96 TPI	32.90	30.90	

48 TPI suitable for 35 or 40 track operation  
 96 TPI suitable for 77 or 80 track operation  
 Please specify sectored versions in column supplied  
 P&P FOC on orders 10 +

<b>TOTAL EX VAT</b>	
<b>15% VAT</b>	
<b>Postage &amp; Packing (50p per box)</b>	
<b>TOTAL PAYABLE</b>	

Name \_\_\_\_\_  
 Address \_\_\_\_\_  
 \_\_\_\_\_ Post code \_\_\_\_\_  
 Tel: \_\_\_\_\_

Strictly cash with order  
 To: Civco Acre Computer Consumables Dept. (PC3)  
 58 Great Cullings Romford RM7 0YL

I enclose cheque/P.O. payable to CIVCO ACRE COMPUTER CONSUMABLES  
 \* Quotes for 8" Datalife Disks, Listing Paper, Printer Ribbons supplied on request.

● Circle No. 160

**ENGINEERS!**

MICROPACS specialises in software for you on Apple, IBM, CP/M etc. TUTSIM, a very popular and powerful DYNAMIC SIMULATION package. PROCESS CONTROL training software, CONTROL system design and analysis. FLUID DYNAMICS package (BHRA approved) for pipework and ducting systems, RELIEF VALVE package, ORIFICE PLATE SIZING. See our advertisement in previous Issues of PC

**INTELLIGENT TERMINAL ROM for the BBC micro.**

**TEKTRONIX 4010 EMULATION**

This NEW PRODUCT was developed at university of Southampton and in use at several sites there makes possible a low cost, Tektronix compatible, intelligent graphics terminal with full cursor support and local hardcopy (graphics and text) and disc file handling, plotting and crosshairs functions of the Tektronix 4010, full use of function keys, optional send/receive transmission speeds, several alpha-numeric modes including 24 line mode to match WORDSTAR, simplex/duplex modes, supports two forms of terminal access break signals, full Tektronix 4010 compatible graphics mode, graphics cursor control via keyboard or joystick, cursor support includes transmit co-ordinates, hard-copy dump of graphics, local file store of host computer's files and local file transmit to host computer file. Files can transferred via the BBC disc from one mainframe to another and are not limited in size by the BBC's memory. Available now as an 8K Eprom at £45 + Vat from:

**MICROPACS Graphics House, 50 Gosport St, Lymington, Hants SO4 9BE. Tel 0590 73503**

● Circle No. 161

Commodore 64  
Small Business or home use  
Diskette  
New from TOTL

# How to manage your time as well as your data.

## Go for TOTL integration

Not only do you get a simple-to-operate high productivity program for your word processing, you also get the full potential of the TOTL range of compatible programs, allowing you to expand your computer-use interactively.

## Program with TOTL Infomaster

This sophisticated but clear data management system gives you control over large-volume, complex information. Features include: maximum of 10 files per disk; 2,500 characters per record; 100 fields per record; 245 characters per field; disk-space your only limit on records; variable record, field definitions; unique key for fast access; records displayed in turn or by field-search selection; exceptional reporting capability – including design, sort-order, subtotals, selection criteria; reports generated in label format.

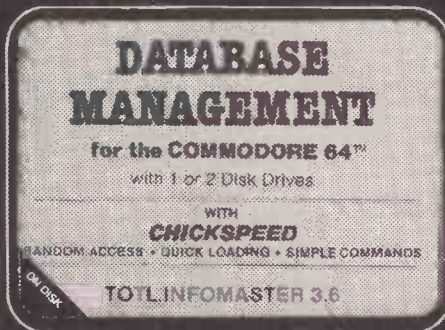

## Call Product Line (0252) 518364

Use our specialist advice unit for queries on program use. This service is free to both users and stockists.

### Your copy of this program

TOTL Infomaster (Cat. no. TOGE 42) is available from all good business computer software stockists. Recommended retail price £49.95 including VAT.

Send me (tick as required)

- The address of my nearest stockist  
 A full specification for this programme  
 Your full list of business products

Please allow 21 days for response.

To: Thorn EMI Computer Software Distributors  
296 Farnborough Rd., Farnborough, Hants., GU14 7NF.

Name \_\_\_\_\_

Address \_\_\_\_\_

APC1



THORN EMI  
Computer  
Software  
Distributors

115

# Annus automaton

Interest in robots is growing. Glyn Moody looks at the state of the robotics industry and finds that personal robots may soon be part of our everyday lives.

THE YEAR of the personal robot could well be upon us. A number of industry experts are comparing the situation for robots in 1984 with that of micros seven or eight years ago. Then as now, machines were rather expensive and crude in their applications and with only a limited range of software. Then came the Apple II and the rest is history.

It is estimated that about 10 percent of micro owners are potential purchasers of

robots, and that the home market will grow to about \$2,000 million by 1990. So it is no coincidence that firms such as IBM and ICL are becoming increasingly involved in the field of robots. One man with faith in such predictions is Nolan Bushnell who set up the company Androbot in 1981. It was Bushnell who designed the first video games and founded Atari. If the success of his third venture approaches that of the other two, domestic robots are set to have

a major impact on people's lives.

Industrial robots have been around for a long time. It was in 1966 that Joseph Engelberger, the so-called father of the industrial robot, installed the first robot in General Motors. Since then a quiet revolution has been taking place as the numbers of robots installed continues to swell, particularly in Japan, the U.S. and West Germany.

The growing interest in robots has been



Top: *Steam Man* painted in 1893 by George Moore; *Bumpy*, built by Jerome Hamlin, 1978; Robot with Alligators, by Toby Buonagurio. Bottom: Toy Acrobat Robot, Japan, 1981; RB-5X from the RH Corporation; Rhino Robots' XR-1.

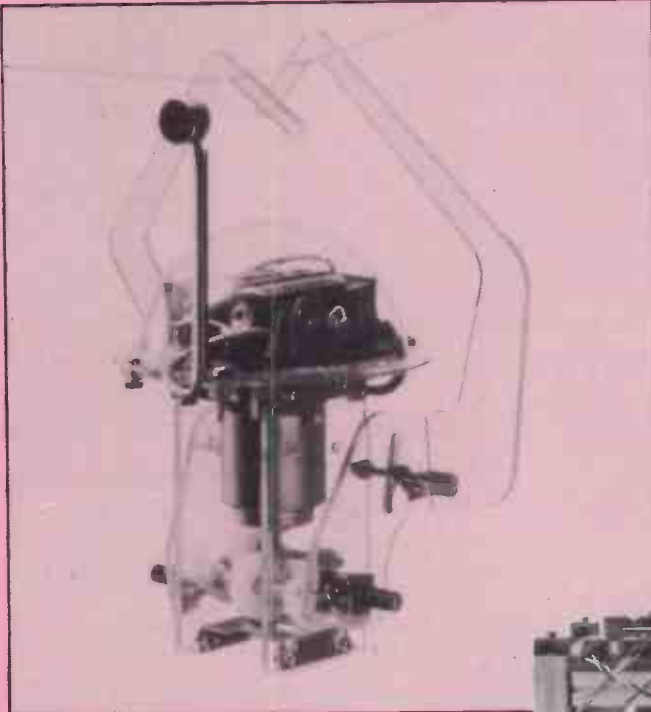

Sound controls Prism's Monkey.

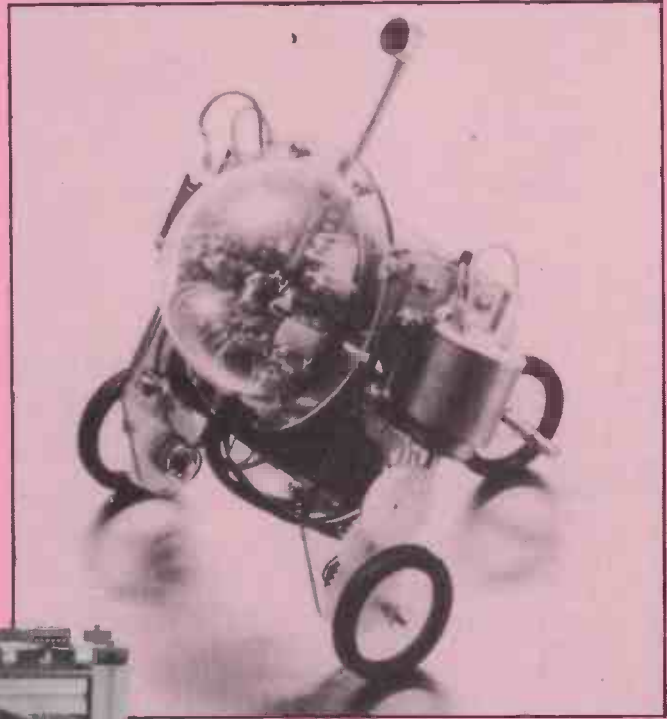

Prism's radio-controlled Pipermouse.

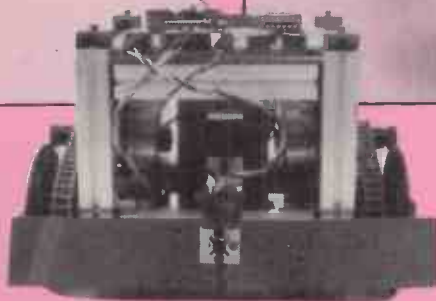

The BBC Buggy — one of the first.

signalled in a number of ways. An International Personal Robotics Association was set up in Paris this year at the beginning of March, and an International Personal Robot Congress and Exposition was held in Albuquerque, New Mexico in April. Also, for the past few months The Robot Exhibit, a major exhibition on the history and cultural significance of robots, has been showing at the American Craft Museum in New York. In Britain a robot exhibition opens at Boiler House project on August 1 at the Victoria and Albert Museum, London.

## More common

Robots have been appearing more frequently in a wide range of contexts. Following the success of *Making the Most of Your Micro*, the BBC recently produced *Computers in Control*, dealing with aspects of control and robotics. A robotic conference formed part of this year's London Computer Fair held in April, along with the very popular Micromouse maze competition.

Other robotic competitions are being organised. BP Oil has recently launched its second robot competition for schools, with total prizes of around £3,000. The competition reflects the growing complexity of robotic tasks: schools are challenged to design and construct a mobile robot butler to serve a drink to two people seated in a room. At the technical college level, the seven finalists in the British Computer Society's voice-controlled robot competition were each awarded £3,000 to construct their machine.

The final seal of approval on personal robotics is the appearance of two magazines in the U.K. For some time in the U.S. there

have been magazines like *Robotic Age* and *Androbot Report*, as well as host of burgeoning robot clubs. The parallels with the heady early days of micros are striking.

The standard definition of a robot is a programmable device consisting of mechanical manipulators and sensory organs which are linked to a computer. So there are three elements which make up a robot: mechanical, sensory and computational. One or more of them may be reduced to a vestigial presence.

The mechanical element is the most obvious characteristic: people have come to think of robots as always having some sort of grappler. But in fact the power of locomotion itself meets this definition, as in Micromice and turtles.

Computational power can either be on-board, as in completely independent personal machines like Hero — reviewed on page 124 — or separate from the robot. In the latter case, in some respects the robot is only a glorified peripheral. The simplest turtles are the clearest examples of this since their use in drawing Logo-style graphics renders them little more than plotters. Even apparently sophisticated robots like Topo from Androbot offer little more. Topo is controlled via infrared signals from a standard Apple II; it possesses no independent computational power. It is probably as similar advanced peripherals to popular micros that robots will begin to penetrate the home-computer market.

One of the crucial elements in the

definition of a robot is its ability to accept feedback from its environment via sensors. This criterion distinguishes the new breed of industrial robots from the automata that endlessly perform repetitive production-line tasks. For example a packing machine which grasps finished products and places them in boxes in a pre-defined way will be unable to respond to any deviation in the product, either in terms of design, position, orientation or even its absence.

A true robotic system, like the advanced welding arms used in fully automated assembly lines, works within certain tolerances in the product, and responds to such small variations with appropriate modifications. The implementations of this kind of feedback is discussed in more detail in the specific case of the Craftsman Robot project at Portsmouth Polytechnic on page 128.

## Not just toys

The simplest examples of true robots fulfilling the three basic criteria are toys such as those recently introduced by Prism. The microrobots respond to sound or infrared light by hopping or wheeling along. Although very primitive in construction, they are more advanced than the first generation of turtles now in common use in their ability to respond to input conceptually.

Sensors range from infrared detectors that enable simple devices to follow a dark line, to ultrasonic receivers which avoid obstacles and sudden drops in floor level. Ultrasonics are used by another personal robot from Androbot, called Bob — acronym for Brains On Board. Unlike Topo, Bob possesses real computing power

(continued on next page)

(continued from previous page)

in the form of two 8086 processors. It also boasts two infrared sensors which can detect humans.

The most complex form of sensor is a vision-based system. Image recognition is one of the the most actively investigated areas of artificial intelligence at the moment. On page 130 you can read how a one-pixel visual recognition system is implemented in the Craftsman Robot project, for instance. The co-ordination of mechanical action with such visual input is one of the main problems in robotics and AI, and indicates the extent to which boundaries between the disciplines are being blurred.

## Repeatability

Many industrial robot arms lack such sophistications. Instead a high repeatable accuracy is used in a more limited range of production situations where tolerances of the product variation can be strictly limited.

An alternative approach is to use robotics in hostile environments such as for welding, paint spraying and metal casting, where a high degree of accuracy may not be necessary. In fact some 20 percent of robots are used for welding, and about 12 percent for painting and casting. Other uses are for general assembly and machining purposes. Half of all robots are used in mechanical engineering and 25 percent in the electronics industry.

Japan leads the world in the use of industrial robots. It is estimated that by 1985 there will be about 25,000 in use in Japanese industry. By then the U.S. will have some 15,000, West Germany 8,000 and the U.K. only 1,500. Demand for industrial robots in Europe will increase by about 12 percent per annum throughout the 1980s, and by 1990 the total European market will be worth about £350 million.

## Britain lags

Clearly Britain is lagging in the race to install robots but there are a number of organisations which give advice and help in this area. The British Robot Association was founded in 1977 by manufacturers, suppliers, academics and individuals interested in the field of robotics. Its aim is to promote the responsible use of robots in U.K. industry. Currently it has about 600 members who receive reports on robotics and a quarterly newsletter. Although the BRA is primarily aimed at those involved with industrial robots, membership is open to all and personal robots may well start to figure in its activities.

The BRA is linked to many other such bodies, both in the U.K. and abroad. One such institution is the Production Engineering Research Association, PERA, based at Melton Mowbray, Leicestershire.

PERA is an independent organisation which provides consultancy and training within the engineering industry. All profits

are reinvested in PERA, and last year a new robot demonstration centre was opened, partially funded by the Department of Industry. The need for such a centre became apparent during the three years that PERA operated the Robot Advisory Service on behalf of the DoI. The Government has made money available to support the introduction of robots; £10 million in 1981 through the Robot Support Scheme, and a further £35 million in 1982 for the Flexible Manufacturing System

Scheme, since the latter often include reprogrammable robotic units.

Personal robots have been around for some time in the form of educational robot arms. Some of these are considered in more detail on page 126. The second-generation machines correspond more closely to preconceptions about what a robot should be and do. Models like Hero, RB-5X and Bob are upright in design and move on wheels provided in the base. They all have on-board processing power, sensors and cost as much as a 16-bit micro. In addition Hero and RB-5X — which are compared on page 124 — possess arms.

Micromice are true robots: they move, they possess sensors — either infrared or

## Manufacturers

**Topo:** Prism Microproducts Ltd, Prism House, 18/29 Mora Street, City Road, London EC1 8BT. Telephone: 01-253 2277.

**Hero:** Zenith Data Systems Ltd, Bristol Road, Gloucester GL2 6EE. Telephone: (0452) 29451.

**RB-5X:** CGL, CGL House, Goldings Hill, Loughton, Essex IG10 2RR. Telephone: 01-508 5600.

**BBC Buggy:** Economatics Education Ltd, 4 Orgrave Crescent, Dore House Industrial Estate, Hardworth, Sheffield S13 9NQ. Telephone: (0742) 690801.

**Beasty:** Commotion, 241 Green Street, Enfield, Middlesex EN3 7SJ. Telephone: 01-804 1378.

## Organisations

**British Robot Association:** 39 High Street, Kempston, Bedford MK42 7BT. Telephone: (0234) 853605.

**International Personal Robot Association:** 66 rue François 1er, Paris 8, France.

**American Craft Museum:** 45 West 45 Street, New York, NY 10036.

**BP Robot Competition:** c/o Mrs Frances Parker, BP Oil Ltd, BP House, Victoria Street, London SW1E 5NJ. Telephone: 01-821 2000.

## The history of robots

The word "robot" first appeared in 1921 in the Czech playwright Karel Čapek's play *R.U.R.*, Rossum's Universal Robots. The word itself derives from the Czech *robota* meaning work. However, the ideas of a mechanical automaton endowed with human characteristics is far older.

The ancient Greek poet Homer refers to mechanical humans and robot-like devices made by Vulcan, the smith of the gods. It was another Greek, Hero of Alexandria, who in about A.D. 100 harnessed steam power to produce simple moving statues. Down the centuries, technological advances went hand in hand with the development of automata designed purely for amusement. Perhaps the most unusual of these was a mechanical duck which digested food, devised in France in the 18th century.

It was not until the 20th century, with the advent of electricity, that robots became a serious possibility. After 100 years of the Industrial Revolution, and with the development of huge sprawling cities, the concept of the drone worker and depersonalised human became all too familiar.

Science fiction took up the theme with alacrity, and in the 1940s the American writer Isaac Asimov formulated his three Laws of Robotics:

1. A robot may not injure a human being, or through inaction allow a human being to come to harm.
2. A robot must obey the orders given to it by human beings, except where such orders conflict with the First Law.
3. A robot must protect its own existence as long as such protection does not conflict with the First and Second Laws.

The reality came from engineering establishments, and arose out of the study of cybernetics, the science of control. One of the first true robots was the Turtle, devised by the Englishman W Gray Walters. Ultimately it was the computer, with its ability to store pre-programmed actions, monitor feedback and formulate responses that produced the robots we know today. The first patents on industrial robots were taken out in 1954.

Now the idea of robots is commonly accepted. Some, like R2D2 from *Star Wars*, or K-9 in BBC's *Dr Who*, are stars and personalities in their own right. It is a nice irony that after striving for 3,000 years to mimic human movements mechanically now humans ape automata in the latest craze of robot dancing.

tactile — and they respond via on-board programs. They represent a problem that is being solved by increasingly sophisticated combinations of robotics and simple expert systems. Alan Dibley, probably the U.K.'s leading Micromouser, discusses some of the construction principles on page 120.

## Turtles

Turtles are perhaps the most popular form of mechanical peripheral used at the moment. From being simple pen-carrying devices they are rapidly progressing to full, sensing robots. Already the BBC Buggy can be equipped with infrared or light-sensitive sensors, and a grab arm is promised soon.

Control systems represent a very basic form of robotics. Often the three crucial ingredients of mechanical action, feedback and computer power are all present as in computer-controlled lighting and heating systems. Alternatively a simpler arrangement of servo controls may be used to

produce basic mechanical movements. Currently the control aspect of robotics is fairly primitive, lacking the glamour of walking, talking robots. But as people are drawn increasingly to practical applications of micros, it seems likely that equipment will become more sophisticated and cheaper. The Beasty range of servo-control units from Commotion represents one of the first steps in this direction.

As with micros, the development of personal robots will be largely a matter of response, which in turn will hinge on price and technical advances. Already the processing power is there, and the cost of RAM chips drops almost daily. Once demand increases, the rather expensive stepper motors which are at the mechanical heart of mobile personal robots will fall in price. Also when the vicious circle of increasing demand and falling prices begins it should prompt dramatic developments in robotics comparable to those seen over the last five years in micros.

On the industrial front, the same cheap processing power is already leading to changes in design and implementation. For example, originally the widely used T<sup>3</sup> robot from Cincinnati Milacron was a mini-based system. Now it is available in multi-micro form, using an 8086 for the master CPU, and six 8085s for individual degrees of freedom. This kind of distributed power will lead to a new overall configurations of robot arms, which will be linked together to form a vast intelligent array, perhaps with a central file server.

## Robotic theory

The enormous general increase in computational ability has led to a whole new field of robotics: theoretical robotics. It is now possible to input the characteristics of the commercially available robot arms and study them by means of computer modelling. For example, the American firm McDonnell Douglas Automation has produced a system which allows real-time simulation of robotic activities, including a check for collisions between different parts of a robot arm with a pre-planned series of movements directly from this. Hitherto, on-line methods have been used whereby the robot was walked through the sequence of actions, either by positioning it manually or directing it via a controller while it was in teach mode.

An OECD report estimates that 20,000 extra jobs would have to be found every day for the next five years throughout the developed world just to reduce levels of unemployment to those of 1979 — and this is before new technology has affected a single job. The West German Commerzbank is more explicit: it calculates that over 500,000 German assembly-line jobs will be threatened by the next generation of intelligent robots before 1990.

## Job loss

So far it has been hazardous and unpleasant jobs that have been taken over by robots. This in itself can cause problems, for it is the relatively unskilled and so perhaps least adaptable workers who are most affected. But robots are unlikely to stop at welding and spraying jobs. As more dextrous models become available, with full sensor feedback, perhaps coupled with rudimentary vision and expert systems, there are few manufacturing processes that could not, in theory, be automated. One report asserts that robots with these abilities in even rudimentary form could cost 3.8 million Americans their jobs. Already one robot manufacturer is warning of worker unrest and sabotage in a new Luddite fury against machines.

The robots are definitely coming, and the developments they will bring promise to be as exciting and far-reaching as those caused by computers. The question is, are we ready for them? □

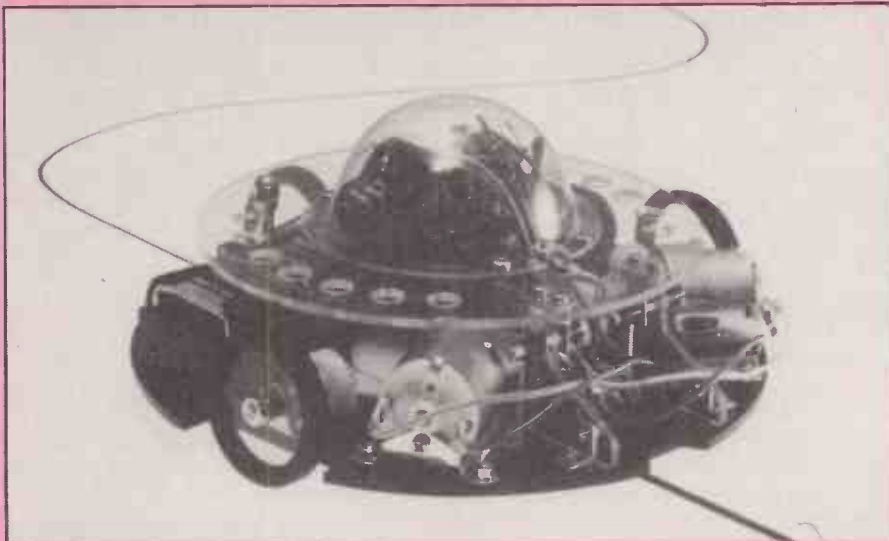

Prism Movit's Line Tracer is infrared controlled.

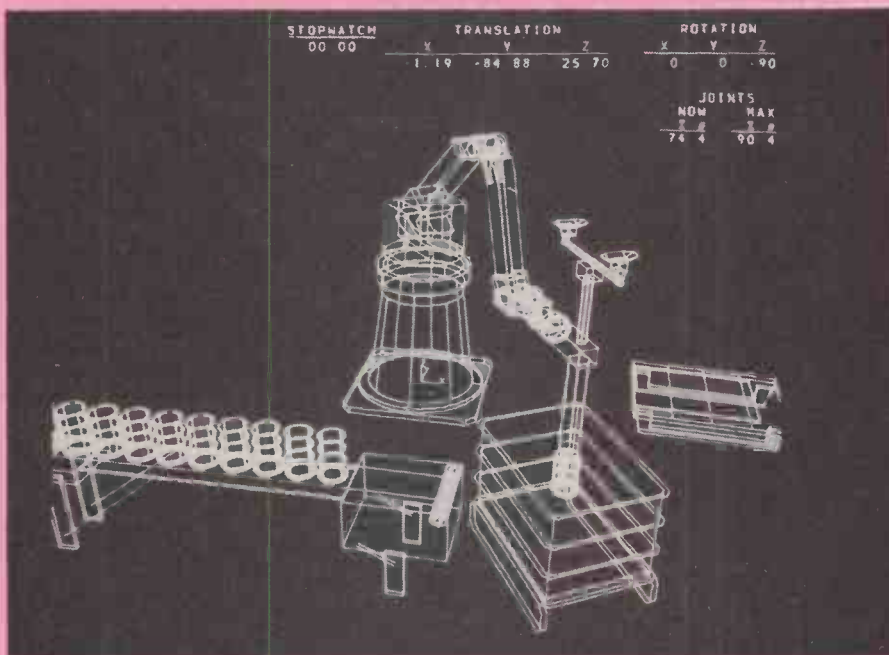

McDonnell Douglas's real-time simulation of robot operations.

# DIY about the mouse

The Micromouse competition takes place at the Earls Court Computer Fair on June 14-17. Champion Alan Dibley tells how he built his race-winning microprocessor-controlled machines and invites challengers for future events.

THE MICROMOUSE competition has come of age, and now the problem facing most competitors is not how to reach the target, but how to get there faster. However, for some reason there are not enough newcomers to the sport to give the old hands the sort of competition they need, and produce novelty in design to ensure that Britain gets its rightful first place in the European championships every year.

The mice I have built, the Thezeus family, have all been based on Sinclair micros and wooden chassis. They use parts salvaged from models, bits of junk, and items that have been saved because they might be used for something, some day. Mechanisms are constructed from piano wire, brass tube, solder and epoxy. The best material to use for tyres is beige rubber bands. A mouse can be built for less than £50, and if an unwanted ZX-81 is used, with an effective cost of zero, it could be much less.

The first mouse I built, venerable Thezeus himself, uses a ZX-80 because that was what I had. Experiments with some TTL chips produced the simplest possible interface — see figure 2.

Thezeus uses microswitches to sense the walls and to measure wheel revolutions. The switches are wired directly across the keyboard connections, so need no port or interface circuit. They are read by a short piece of Z-80 code modified from the ZX-80 ROM keyboard routine. All of the maze-solving logic is written in Basic, and is fast enough for the slow mechanism it controls. Sinclair ZX-80 Basic is very fast because it only uses two-byte integer arithmetic. You do not need floating-point arithmetic to solve a 16 by 16 maze.

The standard 4K RAM pack has an extended cable to allow it to lay down on top of the processor for the sake of appearance. It seemed necessary to keep down the centre of gravity, but the mouse is too slow to topple over in action. The keyboard was cut off with a hacksaw — which hurt because a ZX-80 was still state-of-the-art at the time — and reconnected by a plug and socket. This keeps the processor dimensions within the overall 25cm. limit demanded by the rules.

All motive power and control motions on

Thezeus are produced by model radio-control servos. This is a simple way to produce controlled motion from a micro. A servo needs a standard TTL positive pulse of between about 1ms. and 2ms. duration, repeated every 20ms. or so. Feeding the servo with short pulses makes it position itself towards one end of its travel, and feeding it long pulses makes it settle at the other end, the final position being proportional to pulse length. If you stop feeding pulses the servo stays where it is. The servos are not fussy about the repetition frequency of feeding pulses and between 30 and 80 per second will work. I check by trial and error.

## No overlap

The interface shown in figure 2 allows the port to be addressed by making bit 15 active in an Out command. To prevent overlap with other functions, I use address 80FF hex. A better port could be built using a PIO, but the one I use is adequate. The same interface is still used to control the infrared emitter systems, and the drive-motor switching on the latest mouse.

To make a servo revolve continuously — to be used as a drive motor for instance — you disconnect the internal feedback potentiometer and substitute an external fixed one so that the servo cannot balance its internal position-comparison logic. This produces a servo that goes one way when fed with short pulses, the opposite way when fed with long pulses, and stops when fed with none. However, some servos only have partial output gears, since their intended use for model control only needs about 120° output motion, or they have built-in stops at about 80° from centre, which must be cut away. Second-hand servos can be bought for about a fiver from your friendly local model shop. The high-speed specials for top-notch mice cost about £25.

The method I chose for turning Thezeus seems quaint now, but at the time appeared to be the only logical method to use. He puts a foot down on the floor, lifts himself up about 3mm. and turns around the central pivot which carries the foot. I refer to Thezeus as "he" because in my experience most of the successful mice have been chaps.

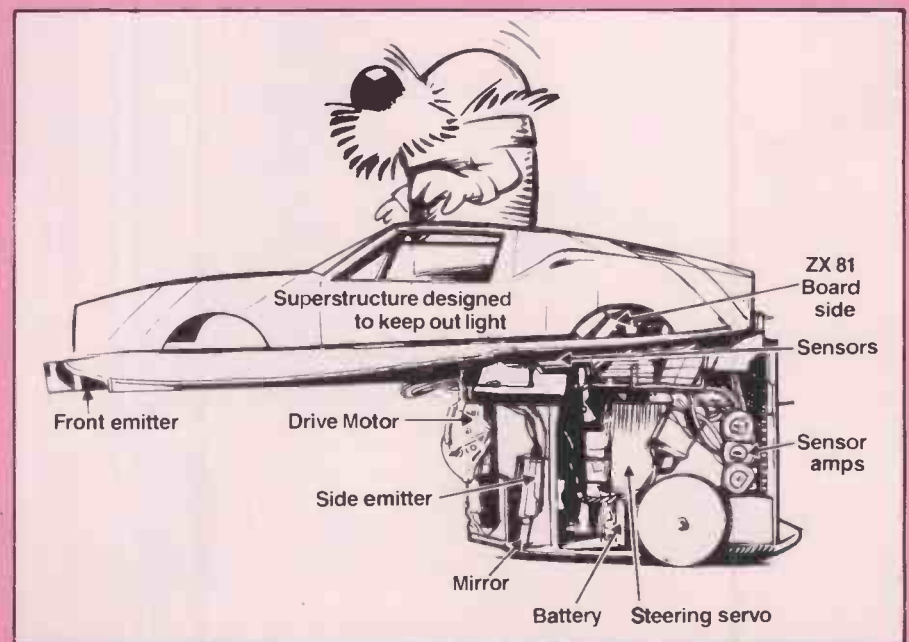

Figure 1. T4's overhang at the front detects a far wall when a square is entered.



Son of Thezeus was faster than his predecessor on the straights and used a different method to turn. He also used 500mAh nickel-cadmium cells rather than Thezeus's 1.2Ah cells, and had an infrared emitter/sensor for tracking wheel motion. But he did use similar mechanical steering and microswitch wall sensors. Mechanical sensors must be retracted during a turn, and result in complication and wasted time, so later versions use infrared sensors, which are also faster to act and do not bounce. The microswitch used to keep track of wheel revolutions on Thezeus would not be reliable at any higher speed.

T3 was my first second-generation mouse, and works quite differently. The single front wheel is driven by a motor and gearbox mounted on a vertical pivot. It is steered by a radio-control servo working through a pair of connecting links similar to steam-locomotive con-rods — but a bit smaller. The mouse has two rear wheels which are free running. The tricycle arrangement allows the mouse to turn about his own centre at corners and dead ends.

## Accurate turning

During straight running, steering is controlled by a hardware system, which consists of a multi-vibrator producing the square waves needed by the steering servo. The mark timing of the multi-vibrator can be adjusted by four infrared-sensitive diodes. If the mouse wanders too close to a wall, one of the two infrared detectors above the wall is obscured from its emitter, which is mounted low down by the back wheel and adjusts the steering servo pulse length. The system only prevents the mouse approaching too close to a wall, not from wandering away from a wall, so needs very accurate turning control. There is a trade-off between accurate 90° turning and instant correction for straight-steering errors.

A separate infrared system is used by the software to detect the presence or absence of walls. It is a simple on/off system used to update the wheel-count tables, at the disappearance of a wall to right or left, and as input to the maze-solver routine. By now the software had become mostly machine code, with a few Basic instructions for setup of maze maps and other storage.

The processor is a ZX-81, built from a kit to allow a few changes like fitting a 6116 2K storage chip and connecting all the bits not needed by the mouse via a plug and socket. The mouse carries only the printed-circuit board and chips. The keyboard, TV modulator, power regulator, and ear/mike/power sockets are in the case mounted on a dummy circuit board, with a 10in. cable to connect to the mouse during loading and starting. A 16K ZX-81 with a printer is used to write the code, using the incredibly fast ZX-AS assembler from Bug-Byte. It is a simple program, but sufficient for the 700 bytes of code needed by the mouse.

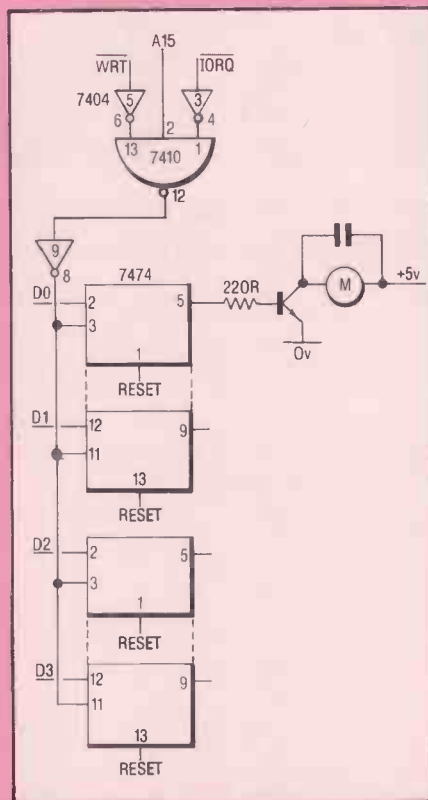

Figure 2. Thezeus's interface.

To turn, the mouse stops at the centre of the square. Then the software takes control of the servo, turns the front wheel 90° left or right, turns the motor on for the correct count of wheel pulses, straightens the steering, switches back to hardware steering control, and restarts the motor. The turning servo actions and delays for braking take too long. So the next stage of development had to be a mouse that did not stop at corners.

T4 was the first non-stop Micromouse. He stops at dead ends, but that does not affect his final shortest run time, since he has learnt to avoid them by then. The chassis of T4 is similar to that of T3 but has much more overhang at the front, to allow detection of the far wall when a square is entered. All functions are controlled by machine code, which fits in about 900 bytes plus 512 bytes for two maze maps. There are still a few lines of Basic to make it easier to set up the mouse ready to run, and I am too lazy to code it into assembler.

By bringing the steering under software control it is easier to make it smart enough to follow one wall, an obvious but significant improvement. The same simple interface is used, and the four functions controlled are motor on/off, steering servo, and two drivers for the pulsed infrared emitters.

The emitters must be pulsed to overcome outside sources of infrared. The sun is the worst source of interference, but although the sun rarely shines in exhibition halls where Micromouse contests are held, there does always seem to be a bank of a dozen 1kW incandescent lamps immediately above the maze.

Some more info on the various bits of T4 may give you some ideas to encourage you to take up the challenge and turn up at a competition to threaten T5. I deliberately have not mentioned him yet, and I will not mention him again since by the time you read this article he may be finished.

Figure 1 shows T4, which uses a drive motor from an old radio-controlled servo, epoxied to a gearbox cut down from a surplus timer mechanism. All three wheels were turned on a model lathe from a piece of plywood to get the exact size required. The rubber band tyres are held on with cyano-acrylate. The light chassis is made as accurately as possible from thin plywood, balsa and card. Such a method of construction has advantages in cutting, sanding, sawing, sticking, drilling, painting and pinning. Also you do not feel too bad if it becomes clear that you should throw it away and start again.

## Fast steering

A ZX-81 processor with 4K of RAM sits on top. The output-port chips and transistors are stuck to the board with double-sided adhesive tape. The power comes from four 500mAh nickel-cadmium cells with no regulator. The steering servo is the fastest I could find and is used by the electric-car racing fraternity. It cost nearly as much as the ZX-81 kit but was worth it.

The wheel revolution sensor disc is made from a washer stuck to the side of the front wheel, carrying alternate sectors of reflective adhesive tape and matt black paint. Two very small diodes watch the segments go past, and are strobed every 10ms. by software. The receiver diode is connected directly across a keyboard contact.

The specification of the software to drive a mouse is surprisingly complex. First it must collect information from sensors, which may be an active task involving control of infrared emitters and strobing a dozen or more receivers. Most of this information must be stored for later use by the maze-solving routine and the route-decision function. Also in most mice, software controls the steering. Further, it should be capable of some error recovery to cope with transient mechanical problems, since competition mazes have bumps in different places to those you get used to at home. Finally, it must keep track of where the mouse is in the maze, and which way he is facing. Some builders use hardware assistance for some of these functions, depending on their individual skills.

But it is not necessary to write everything at one attempt. Try a step at a time, write a bit of code to turn a motor on and off, or steer with a servo.

For rules of the Micromouse competition and entry information write to John Billingsley, Department of Electrical and Electronic Engineering, Portsmouth Polytechnic, Anglesea Road, Portsmouth PO1 3DJ. Entry is free.

# Turtle tussle

Christopher Roper looks at the two British contenders for space on the nation's classroom floors, demonstrating control technology at its simplest.

WHEN Seymour Papert first began to experiment with computers in the classroom in the mid-1960s, the most usual means of communicating interactively with a computer was via a Teletype terminal. Visual display terminals with bit-mapped screens were still several years away and user-friendliness was not even a glint in the copywriter's eye.

Papert looked for some way of externalising the workings of a computer in a way that would make sense to a child. His idea was a wheeled robot which could draw in response to simple commands: Pendown, Penup, Forward, Right. He called it a turtle in honour of the British neurophysiologist and cybernetician Grey Walter, who had built electric tortoises with simple feedback mechanisms in the 1950s.

## Near extinction

Papert and his colleagues at MIT developed the programming language Logo for use with the turtle. By the time it escaped from the confines of MIT and Edinburgh University, on the wings of the microcomputer revolution, the turtle was almost extinct as a physical object. Papert's original had long since rusted away in a basement at MIT. The turtle was now conceived as a moving cursor on the monitor screen: Pendown and it left a trail, Penup and it moved without a mark. A floor turtle was an expensive peripheral.

But several Logo enthusiasts rightly saw the floor turtle as a way in which scarce computer resources could be shared among a large number of children. Also they saw that part of Papert's original idea had been lost with the coming of the screen turtle. A turtle on the floor, actually drawing pictures under control of a program written by a child, provided a clear conceptual bridge between concrete events in the real world and the abstract workings of a computer program.

For example a child could walk itself through a square

```
Forward 50
Right 90
Forward 50
Right 90
Forward 50
Right 90
Forward 50
```

and then give the same instructions to the turtle. Furthermore, as well as ideas about programming, children could learn important concepts underlying control technology.

Today there are two British turtles on the market: the Jessop and the Valiant. The

one built by Jessop Microelectronics is a direct descendant of the turtles used by Sylvia Weir at Edinburgh University in her pioneering work with children with special learning needs. John Jessop built the prototype out of brass and steel from blueprints supplied by Edinburgh. There was no attempt to make it look like a turtle.

In 1981, he built 20 turtles, not so very different from the prototype. The pen arm had to be heavy because they had not designed a spring to hold it on to the paper. The original turtle was driven by commands from an Edinburgh program, known misleadingly as OKLogo — its critics say it is neither OK nor Logo.

Late in 1982, the first mass-produced turtle came off the Jessop assembly line. It cost £350, which was a lot of money for a primary school to raise, but it was costly to manufacture. The Perspex domes were blown, not moulded, and each baseplate had to be tailored to fit a particular dome. If the dome was trodden on and broken by its infant controller, the whole thing had to be dismantled and needed a new base.

A serial interface was used, which required a substantial box of circuitry between the computer and the turtle. This disappeared with the introduction of the present parallel turtle in 1983 and the price was more than halved to £165. Sales have since shot up. Now Jessop turtles can be driven by a variety of Logos, including both Apple II versions of the language, and

Dart, a turtle-graphics package on the BBC Micro.

David Catlin of Valiant Design has been thinking about floor turtles since 1981, but only launched his design this year. The Valiant's infrared remote control may give it the edge it needs in penetrating a market where the Jessop turtle is well established. On the other hand, Jessop's remote control unit is almost ready for release. But in general children should benefit from the existence of two competing manufacturers. Turtle consciousness will rise, prices will drop, and new features will be added.

## Pentagonal shell

Whereas Jessop is an engineer and his product reflects this, Catlin is a designer, and this has led him in a different direction. His turtle looks like a turtle, with a beautiful pentagonal shell. Catlin is also concerned to provide a total educational package with documentation modules aimed at teachers, parents and children.

Catlin has some nice ideas for turtle use. One of the first packages allows children to alter the units of turtle measurement. When you say:

Forward 100

you can specify whether the units are centimetres, inches, feet or metres. This is possible with the Jessop turtle, but you have to alter the machine-code control program, so the facility is not yet open to

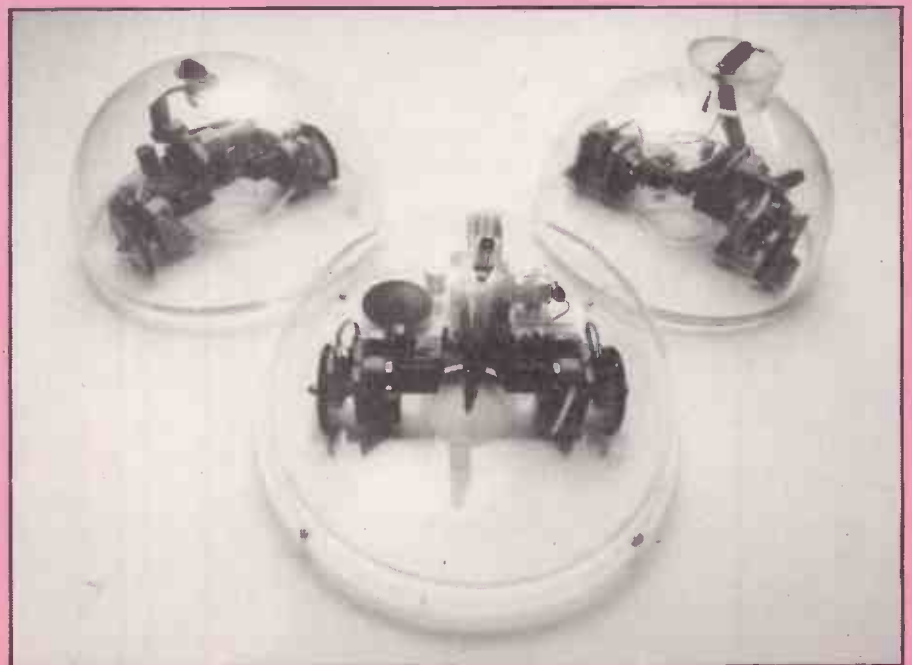

The three generations of Jessop turtle with domes of blown Perspex.

novice programmers. Similarly, angles can be measured in radians or degrees.

A major difference between the two turtles is that the Jessop turtle uses two Swiss-made d.c. motors to drive the wheels, which are controlled optically. This is the true cybernetic way to do it. When one of the two wheels has travelled the required distance an optical sensor feeds the information back to the computer and the motor is cut out. The Valiant uses stepper motors, with no feedback from the turtle to the computer. In fact provided the control unit is switched on, the Valiant software will run perfectly happily, whether or not there is a turtle around. This is quite a serious defect, in that the program does not detect the relatively frequent event of a body blocking the signal.

## Potty look-alike

Derek Radburn, chairman of the British Logo User Group, BLUG, is also headmaster of Long Clawson Church of England Primary School in Leicestershire. The children at his school road tested both turtles. Several of them liked the Valiant best. Clare Parker wrote: "I like the green (Valiant) turtle best because it is more like a turtle. I don't like the other one because it reminds me of a potty." Lynne Cartwright was more practical when she wrote: "The other turtle is much faster but is nowhere near as accurate."

Another pupil, Marianne Lumb demonstrated the difference in accuracy and speed with a routine to draw an eight-point star

Repeat 6 [Forward 60 Right 135]

The Valiant produced a perfectly closed figure, whereas the Jessop did not. Considered simply as a plotter, the Valiant won out, although it took 2 minutes 27 seconds to draw the star against the

speedier Jessop's 1 minute 10 seconds.

Mr Radburn praised the accuracy of the Valiant turtle, but commented that it was a prototype, whereas the Jessop was a production model. Later we learnt that the Jessop turtle could be given the same degree of accuracy by adjusting the front wheel.

He also liked the fact that the Valiant uses standard Berol pens, which are easily and cheaply obtainable — unlike the Jessop, which uses a special pen. On the other hand, the Jessop lifts its pen higher off the floor, avoiding the Valiant's habit of drawing a dotted line when its pen is up because the paper is rumpled. Changing the pen on the Jessop is also much easier, where it would be quite easy to damage the Valiant turtle when performing this operation.

Two design modifications for the Valiant turtle were suggested by Mr Radburn. He felt that the infrared control box should have a longer lead so that it could be moved around, as there can be problems with children blotting out the signal by interposing their bodies. His other suggestion was to provide a rechargeable battery pack. At present, the turtle cannot be used while its batteries are being recharged. This is not a desperate problem as it lasts through a normal day of classroom use, provided you remember to switch it off when it is not in use.

But with a rechargeable battery pack a busy school might have two battery packs to a single turtle. It would also be useful to include a circuit to switch off the turtle if no command has been received within five minutes.

Valiant Design plans to give its turtle a voice and sensors which will tell it when it is going to run into a wall or some other obstacle. It seems clear that if the link with the computer continues to be an infrared control box, the turtle's response to

information of this kind will have to be determined by on-board intelligence, and not by the program. The Valiant turtle already has a great deal more on-board circuitry than the Jessop, and this may give Jessop better control of manufacturing costs if competition stiffens. Jessop insists that his remote-control unit will retain the principle of full two-way communication between the turtle and the controlling computer, with a serial interface on the turtle.

The two turtles are roughly comparable in price at £150 plus. Both are well made and well designed. So which do you buy? If your aim is simply to provide an object in the real world which can be made to move about under computer control, the Valiant is the more attractive option in many children's eyes. It was evident that the less a child was interested in computers, the more they were likely to prefer the Valiant. Paul Asserati, a born hacker of nine, said: "I like the Jessop turtle because it is faster, and I think it is more equipped with Logo. The green turtle is very slow and it cannot hoot."

## Doubts

My and Derek Radburn's doubts are that we have not seen the Valiant documentation, though there is no reason to suppose it will not be good. Second, David Catlin may find it harder than he expects to provide significant enhancements without two-way communications between the turtle and the computer.

If you are working with older children, on the other hand, and want to teach them something about cybernetics, control technology and the robots, opt for the Jessop turtle, which is classically designed according to principles which can be applied by budding engineers to a number of other fields. The fact that Jessop provides a full machine-code listing of the control program, with pointers to variables which can be changed, could be a decisive advantage for any teacher or hobbyist interested in studying control. This may also give the Jessop turtle the edge when it comes to adding enhancements. The Jessop turtle has never been aimed at secondary schools, but given the current interest in control technology and the cost of any robots, this may change. In that market, the Jessop turtle is competitively priced.

Another consideration to take into account is that Jessop has a track record of successful manufacturing, with a number of well supported products. Valiant Design, on the other hand, is an untested one-product company.

With the arrival of true Logo on cheap microcomputers like the Sinclair Spectrum and the Atari, interest in turtles is likely to increase this year. Control technology, robotics and Logo are already flavours of the month in educational-computing circles. By combining all of them in one package, turtles should have it made. 

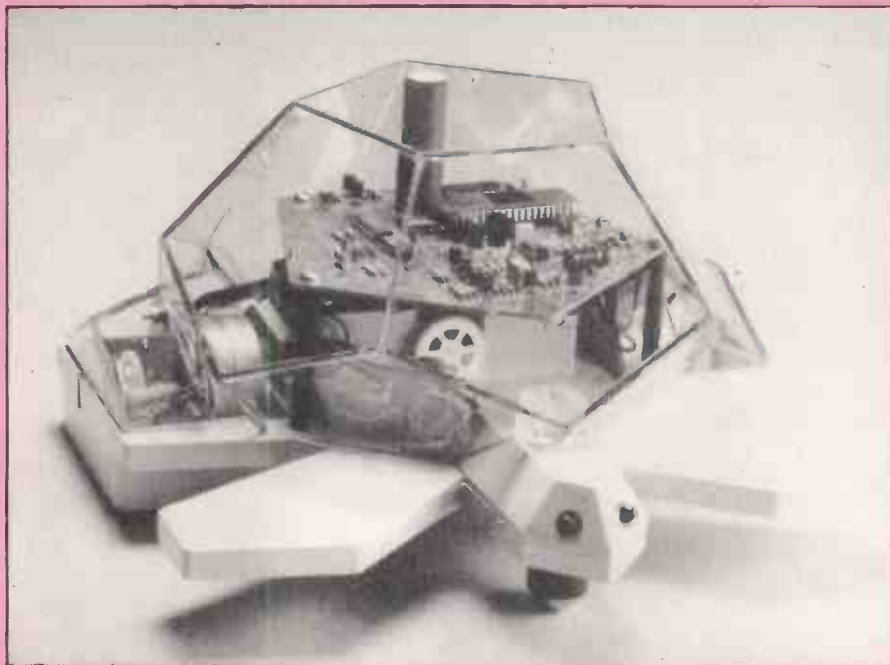

David Catlin's Valiant turtles are designed to look like turtles.

# Family runabouts

**Boris Allan compares the leading two robots available in the U.K. for the home and education market.**

THE KEY QUESTION is "Why buy a robot?" I have some answers, but they lead me to believe that it will be some time before the robot in the home is feasible, or desirable. My conclusions have partly been formed as a result of my experiences with two excellent little robots: Hero 1 and RB-5X.

Hero is the smaller of the two robots and is already a television star: it is the robot which appears on the children's serial *Whiz Kids*. Most of the sales in the U.K. for the larger RB-5X robot have been to advertising and PR agencies — a robot does

not have to be a Topo to be a media event. Both robots are designed to be practical items but the way in which they are practical differs.

Hero is made by Heathkit, an American firm well-known for its construction kits. Hero comes as a kit, and you build the robot with the aid of your trusty soldering iron, together with very complete plans and instructions. One of the aims behind Hero is to teach how an industrial robot is constructed.

The documentation which accompanies

Hero is very much orientated towards the educational, constructional and electronic implications of robots. Used as such, Hero is a valuable adjunct to many of the increasingly common information-technology courses and, what is in many senses more important, using Hero is fun.

## Experimentation

The emphasis in RB-5X is on the software. RB-5X can be programmed in National Semiconductor's Tiny Basic. The accompanying literature says that the "X" of the RB-5X stands for experiments, and you are encouraged to try out artificial intelligence experiments.

You are provided with programs in Tiny Basic to produce a learning robot, which will attempt to remember the layout of a room or maze, for example. The programs are based on work by David L Heiserman, a well-known writer on practical robotics.

At £1,600, Hero is the cheaper of the two robots. One reason for this is that Hero comes in kit form. For those who want to learn from the construction process Hero is ideal, but if you want to buy a ready-built Hero you will have to pay about £2,500. Prices are fluctuating all the time. Maplin Electronic Supplies, which supplied a demonstration and a ready-built Hero, suggested that the price might soon be coming down.

Although the manuals provided are comprehensive and painstaking, for the person inexperienced in practical electronics, Hero is frightening. Otherwise constructing Hero is a large, but very satisfying project, and ideal for group work. Seeing the way in which all the different sensors are connected is a valuable learning experience.

## Sensors

There are a fair number of sensors, the most confusing of which, during my trial of Hero, was the sound sensor. I used the sound sensor to count handclaps, and found that Hero could not count. I was assured that this was probably due to kids messing with Hero at the last exhibition. On asking around, I found that no other person who had used Hero had encountered this problem, so I reckon this is probably true.



Hero comes in kit form — a daunting prospect for the inexperienced.

Hero can make noises which have a faint resemblance to human speech, and I was taken by the vigorous rendering of *Old MacDonald has a robot*, one of Hero's standard party pieces. As with most computer speech systems, Hero's use of language is based on the use of sound groupings called phonemes.

## Phonemes

To produce the sound of the word "cat", the phonemes for short C, short A, and short T, are entered. Of course, if you are a user of a certain dialect, you would input phonemes for short C, long A, and short T, and have the computer pronounce "cart". True ability to speak will come when it is possible to input the character sequence "thorough", and have the word pronounced in the correct manner without the user entering phonemes. There are other sensors built into Hero, including distance and light sensors.

By turning Hero around, and using the light sensor, I was able to locate the brightest light. Taking the ability to recognise light together with its ability to react to noises, Hero can be used as a security device.

Hero has a sleep mode, in which it shuts down operations for about 10 seconds to conserve its batteries, reactivates and, if nothing is happening, deactivates again. The sleep mode is useful for using Hero as a silent sentinel, and the system uses Hero's real-time clock to control operations.

What makes Hero similar to what we expect of a robot is its ability to trundle and grab. Hero can be programmed to move under the control of machine-code programs entered in hex via a pad in Hero's head, or be taught a sequence by use of a control pad attached by a cable.

## Arm movement

The use of the robot arm can be interspersed among the movements, if desired. Both the type and the precision of movement, and the flexibility of the robot arm are rather more rudimentary than that of RB-5X.

The central processor for Hero is the Motorola 6808, which uses the same machine code as the 6800. Only two chips are needed for the 6808, compared to the five necessary for a minimum system using the 6800. In addition to programming the 6808 in hex by use of a pad, there is also a robot language with some extra commands for controlling devices. Direct access to registers, especially the program counter, is simple to achieve. Hero is excellent in the way in which users are encouraged to extend the robot by adding new components — Maplin had added a set of flashing lights to indicate various operations.

Most of the facilities of Hero are replicated in one way or another on RB-5X. Most of the facilities are more advanced on RB-5X. One extra facility which is of great

assistance for intelligent behaviour is the eight bumper-panels situated around the perimeter of RB-5X.

The robot arm, which is neatly curled inside its head when not in use, is a precise device and far more adaptable than that of Hero. RB-5X costs about £3,000, and although its price is possibly reducing soon, it is not a cheap way into robotics. But RB-5X is distributed by CGL, distributor of the Sord M-5, and the company does not see RB-5X as a mass-market robot.

Though Hero can be programmed in Microsoft Basic with the addition of an on-board CPU, where the program can be loaded from an Apple or from cassette, the main thrust is machine code. With the RB-5X you program in Tiny Basic from the beginning, controlling devices by use of memory-mapped input and output.

A computer is used to write a Tiny Basic program as a text file, using special communications software. The text file is loaded into RB-5X via an RS-232 interface, and the program is then run. At the moment there is software available for the Apple II+ and the Osborne 1, and CGL hopes to be able to interface the Sord M-5.

The microprocessor used is National Semiconductor's 8073, a development of

the well-tryed SC/MP, or Scamp micro-processor. Other languages available are Robot Control Language, RCL, and a software package, Savvy, and there are facilities to plug in EPROMs for specialist tasks.

## Conclusions

● Both robots work as well as one can reasonably expect, given that they are not R2-D2.

● Both robots are far too expensive for home use. If you had one of them in the home, the best use you could make of it would be to find out what is the possible potential of robots.

● Given the usual margins on computers and similar electronic gadgets, neither robot is overpriced for what it does.

● Education is a major market for robots. Hero gives an excellent insight into the workings of robots in general, and RB-5X allows people to try to come to terms with controlling robots. For courses in IT, electronics and similar, Hero is the obvious purchase.

● RB-5X is more interesting as far as software is concerned.



At around £3,000 RB Robots' RB-5X is hardly a mass-market device.

MICROCOMPUTERS are playing ever more important roles in the control of industrial robots. Until recently most robotic systems had been using programmable controllers, through which every move was carefully planned and plotted manually. But now certain companies have introduced packages and systems suited to the factory environment and automatic programming, which can only pave the way for more micro manufacturers to tread the same way shortly.

The main difficulty in realising computer control of robots is accuracy. A robot arm being used for welding or paint spraying has to return to the same reference point in space eventually, which is all down to accurate machining of the robot in the first place. The problem is made more complex because robot arms have to be able to reach all the areas that need spraying or welding quickly to make it worthwhile using robots at all. So industrial robots need to have flexibility, speed and accuracy.

## Short programs

Programmable controllers can store only short programs in their small memories, but links are available that enable simple programs to be downloaded from mainframe computers. However, they have to be written on a robot-control system first and then stored on floppy discs or tape. Typically, robot controller memories hold up to nine or 10 short programs at any one time. Any one of these can be edited, usually a line at a time, as on small portable personal computers such as Epson's HX-20.

# Industrial

More powerful controllers of robot systems are the minicomputers that GdA of Munich uses in its HDS robot systems. The electronic components of the system are based on the PDP-11/23 minicomputer from DEC, and the software programs have been developed by GdA.

## Robotic movement

The usual way of defining robotic movement is in short steps between two points. If the speed that the robot moves is kept constant over the entire path of travel, there need not be any stops at intermediate points. In this way, robot arms can be programmed to move in circles and ellipses, as well as lines and polygons. Thus programming can be carried out using the keyboard and monitor instead of a hand-held device.

The use of such sophisticated control equipment brings greater memory capacity to robots. In the standard version of the GdA robot, one controlling program can maintain almost 33,000 dynamically controlled program units. Each of these program units can call up 31 additional program units in the form of sub-programs, which in turn can call up further sub-programs.

The increased intelligence of industrial robot systems has other advantages. Robot

arms typically have five or six axes of rotation, or degrees of freedom, and these relate directly to the joints of a human arm: shoulder, elbow and wrist. With the increased sophistication of mini and microcomputer controllers, seven or eight axes can be activated, and these may be used for controlling, say, a rotary table for arc welding. This can prove useful for manoeuvring large or intricate jobs of work such as bicycle frames.

Because of the control system that GdA uses is based on Digital Equipment's Q-bus it is compatible with all DEC equipment. At some time in the future, it may be possible to introduce the Rainbow micro into the system, perhaps in some kind of distributed robot-control system.

## Micro control

Another company bringing micro-related control systems to industrial robots is Cincinnati Milacron. The U.K. arm of this American company is based in Biggleswade, Bedfordshire. The mechanical system to be controlled is Cincinnati's own six-axis servo-operated device. This may be supplied either hydraulically powered for heavy loads, or electrically powered for lighter work.

The controller consists of a rack of several boards using microprocessors from

## Colne Robotics

The Armdroid has five axes of rotation and is a continuous path machine. In other words, it can use several joints-at once to perform a programmed move sequence under microcomputer control. It comes assembled or in kit form.

Colne expects the robot to be used mainly as an educational development tool in homes, schools, factories and research laboratories. It stands 310mm. (12in.) high on a base 150mm. (6in.) x 230mm. (9in.). The robot weighs 3.5kg. (7lb.) without its power pack.

The robot Armdroid can be used manually, via hand-held control box, or under computer control. It can be driven by most popular microcomputers, which see the arm as a peripheral. Colne recommends the robot for use with Apple, Pet, Acorn, Tandy, Spectrum ZX-81, RML 380Z and BBC machines amongst others.

The robot has an interface board for a eight-bit bi-directional parallel port. Microswitches to help the robot position itself are optional.

The robot's gripper is three fingered and it can distinguish objects 4mm. apart. Maximum reach of the arm at full stretch is 430mm. and the robot can lift 300g.

Software and power packs are available from Colne. The system costs £495 plus VAT ready assembled, and £445 in kit form.

For further details contact Elizabeth Newbery, Colne Robotics, Beaufort Road, off Richmond Road, Twickenham TW1 2PQ. Telephone: 01-892 8197/8241.

## Cyber Robotics

Cyber has a range of robots for use in various applications. The Cyber 310 educational robot's operating system is an extension of Forth called RoboForth, which permits individual complex motions to be learned, combined and played back.

Forth is a fairly standardised language that does not suffer from problems of dialect and therefore this robot can be used with most microcomputers, including Apple, Atari, BBC B, Pet, Spectrum and Timex amongst others.

The adaptability of the language permits speed control, which is important to keep attention at demonstrations, says Cyber. The language will allow slow movements when close analysis or critical control is required. Joints can be moved simultaneously, emulating a full-sized industrial robot.

The Cyber 310 has five degrees of movement, a programmable gripper action and it can rotate its shoulder through 300° in the vertical plane. This enables it to operate on the opposite side with the arm upside down thus increasing the robot's flexibility.

The robot stands 1,216mm. (47.9in.) high on a base 300mm. (11.9in.) x 300mm. (11.9in.). It weighs 16kg. (35lb.).

Cyber is designing a complete package of software for the robot, which costs £650 plus VAT.

For further details contact Catherine George, Cyber Robotics, 61 Ditton Walk, Cambridge CB5 8QD. Telephone: (0223) 210675.

# muscle

Steven Sonsino foresees a robot population boom about to hit the factory floor.

Intel. The master CPUs are 8086s, which are responsible for executing the stored programs, communicating with other devices and directing the other processors. These are six 8085s, which control and co-ordinate the axes of the robots. Each 8085 handles two degrees of freedom. Cincinnati is considering using the 8087 micro-processor to speed up some of the positional computations.

Apart from routine industrial work previously done by humans, robots can be put to work usefully in dangerous environments. Robots can remove human operators from the dangers of arc glare, heat, noise, radiation, dirt, metal slivers and fumes from molten metals or volatile liquids. And as more and more production processes become automated, so more robots will oust human workers from factories.

## Japanese users

At present the signs are that the world robot population is increasing fast. Figures from a report issued recently by the Ministry of International Trade and Industry reveal Japan as the world's largest user of industrial robots. By 1990 500,000 robots should be in operation there, which is five times the present number and 50 times that of 1981.

The report also states that the Japanese work force will need major retraining to avoid massive unemployment. However, the Ministry remains cautiously optimistic, pointing out the benefits that robots will bring to non-manufacturing sectors such as offshore development, and medical and social services, where robots could perform tasks for the elderly and disabled, allowing them to remain in a home environment rather than enter hospitals.

Back in the U.K. amidst reports that the

British robot industry is heading for a shake-out, Syke Instrumentation, a small company in Liss, Hampshire, is planning to launch a cheap £16,000 robot. The robot is a fraction of the weight of a normal small robot and it is operated by a very small motor. It was invented by Howard Clarke, managing director of Syke and Dr Frank Nagy of Salford University, and is aimed to fill the niche between desk-top teaching robots and fully specified industrial machines. 

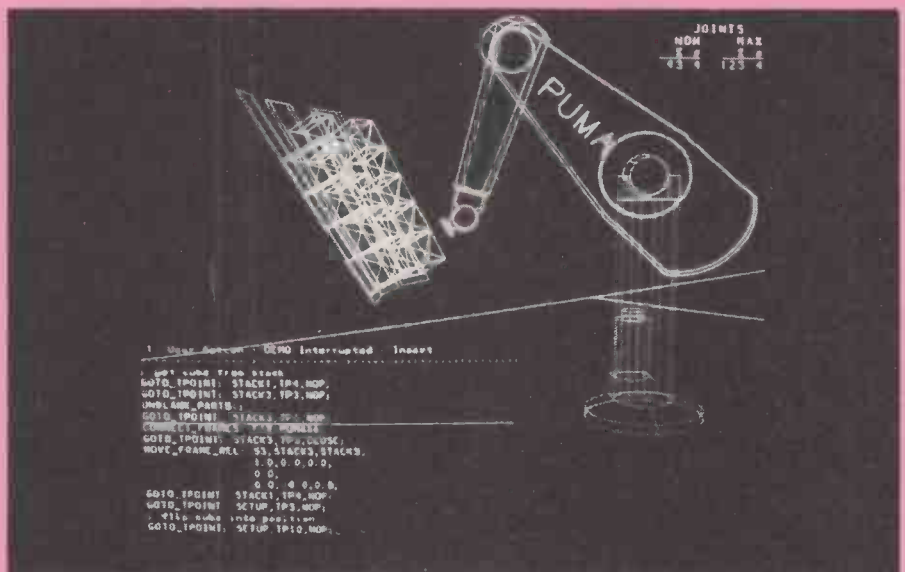

## Feedback Instruments

The HRA-933 robot arm has six controllable degrees of freedom — five axes plus gripper — and is operated from a built-in hydraulic power supply. The arm has position sensors on all axes except the grip. The shoulder can rotate through 90° with a vertical movement through 90° also. The elbow can move through 90° and the wrist rotates through 180° with a vertical movement of 60°.

The gripper has a 50mm. jaw and the arm has a maximum reach of 1m. It can lift up a 2kg.

The processor unit contains a 6802 microprocessor with battery backup, and defines each movement with an eight-bit word. A display gives visual indication of the control mode, program number in the range 0 to 7, and beeps whenever data comes has come in. Movements set by the control box are inserted to form a remembered sequence of operations up to 32 steps.

An RS-232 interface allows other computers to be attached to the robot, including the Pet, Acorn and Apple II, and Feedback's own MAT-385. The control box of the robot can make the robot move up and down, rotate/grip, insert, play, clear and so on.

The robot stands 500mm. (20in.) high and stands on a base 280mm. (11in.) x 190mm. (7.5in.). It weighs about 34kg. (75lb.). The HRA-933 costs £2,195 plus VAT.

For further details contact Feedback Instruments, Park Road, Crowborough, Sussex TN6 2QR. Telephone: (08926) 3322.

## Powertran Cybernetics

The Genesis range of robots provides an introduction to robotics for education and industry training.

The top-of-the-range P-102 operates from 240V or 120V a.c. or from a 12V d.c. supply. Up to six independent axes are capable of working at the same time. Except for the gripper, all of these have microswitch sensors to provide positional control by a closed loop system controlled by a dedicated microprocessor.

Movement sequences can be programmed into the robot by a hand-held controller, or the system can be linked to a separate microprocessor through an RS-232C interface.

The P-102 has a two-speed control, more memory than the basic models and double-action cylinders for more torque in the arm- and wrist-joints. The robot can thus lift up to 2kg. whereas feeble members of the range can only manage 1.5kg. or 1.8kg. The P-102 weighs 36kg. (79lb.) and it is available assembled or in kit form. As a kit, the robot costs £1,476 plus VAT; the kit-form Cortex micro costs an extra £295.

For further details contact Powertran Cybernetics, Portway Industrial Estate, Andover, Hampshire, SP10 3PE. Telephone: (0264) 64455.

# Crafty moves

Robots have been viewed as machines to relieve humans from the repetitive donkey-work in factories. John Billingsley writes about a project being undertaken to extend the scope of robots to more skilful applications.

ON THE HEELS of the microprocessor revolution, the robots are moving in. All the fundamental principles of robotics have been about for a good many years. Servo controllers which could control joint axes were common in gun aimers in the Second World War, and the minicomputer which directs one of the early robot best sellers was launched around 15 years ago. So why has it taken so long for the robot to make its mark?

Until recently, the computers which are needed at the heart of a robot have been relatively expensive. This made the price of a robot astronomically high, rather than merely outrageously high. Machine tools tended to rely on punched paper tape, and computer numerical control was something very special. Low-cost robots started to enter at the toy end of the market, and it became apparent that robots were about to follow the microprocessor in the transformation of their price-to-power performance. Now organisations such as the Laboratory of the Government Chemist are starting to take the bottom-end robots seriously in the possibility of their application to laboratory functions such as weighing and measuring.

Sensing the oncoming surge of robots, the Science and Engineering Research Council introduced a Robotics Initiative to prime the research pumps and promote advanced projects in the application of robotics to industry. One of the many projects to receive support under this scheme has been that of the Craftsman

Robot, undertaken at Portsmouth Polytechnic and additionally supported by the loan of a Unimation Puma 600 robot.

It seems wasteful to limit the use of computing power in a robot control system to performing position calculations and handling manoeuvres. Cannot an integrated system perform adjustments on the

product which exploit instant calculating power? Perhaps the robot can go beyond the performance of pre-programmed repetitive operations and apply craftsmanship to the product. Traditional production methods require each part to be made to an accurate specification, so that any combination of components can be put together without an excessive build-up of tolerances. Such accuracy often has nothing to do with the eventual function of the device, only with the ease of its assembly.

In contrast, skilled artisans will shape a later component to take account of any variations in the workpiece. They will test the finished product, learning from any mistakes and making subtle variations in the design as they proceed. Coupled with the inherent precision of a robot, such techniques could produce a substantial improvement in production.

The task selected by the Craftsman Robot project to try out the principle was the adjustment of an energy regulator. Five of these are used in the average electric cooker to regulate the supply of power to the cooking rings and the grill. A bi-metal strip carries a resistive winding connected in parallel with the cooking ring. When the ring is switched on, the bi-metal warms up until it bends and breaks a contact. Bi-metal and ring then cool down together until the contact is remade. The result is a mark-space cycle which determines the mean power supplied. Turning the knob on the cooker rotates a cam in the regulator,

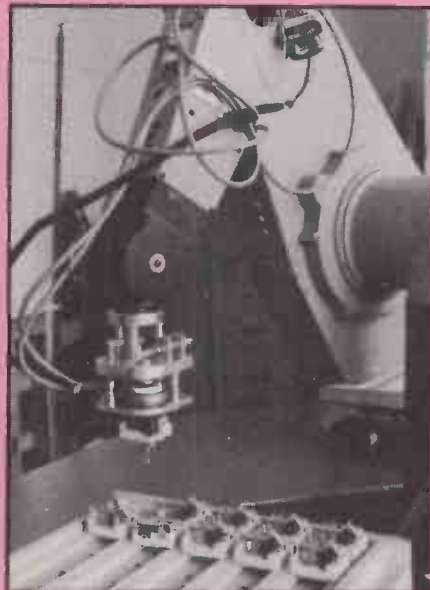

The robot arm starts the process by picking a regulator off a tray.

John Billingsley is a Reader in Electrical and Electronic Engineering at Portsmouth Polytechnic

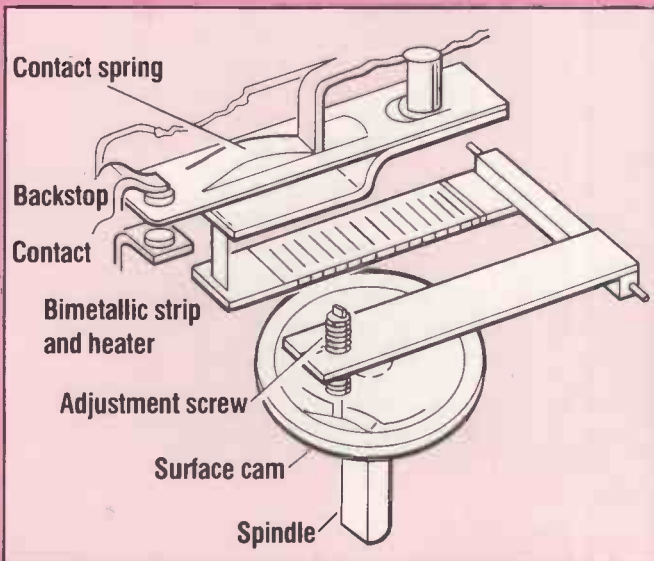

The energy regulator to be adjusted by the system.



Human operators remain cheaper than the Puma arm.



changing the switching point and hence the mark-space ratio. To establish the relationship between knob and ratio, a small screw must be adjusted during manufacture. This is the task for the robot.

It is not as easy as at first it seems because the ratio takes two minutes or more to measure. Instead the adjustment must be made in terms of the cold switching angles, which are set to prescribed values by twisting the knob shaft to and fro and detecting the switching action. Since the hysteresis varies from unit to unit, both angles cannot be set by a single adjustment and a decision must be made either to accept a calculated compromise or to make a further separate adjustment.

The functions of screw adjustment and of simultaneous knob shaft twisting are not part of the stock-in-trade of any standard

robot. Instead two special servos had to be constructed, in effect forming two extra robot axes. It would have been nice to control these by means of the LSI-11 accompanying the Unimation Puma robot which is used for handling the regulators, but the hardware and software of the Puma are built into an almost watertight system, and to use the machine in a way not envisaged by the manufacturer is a labour of Hercules.

The shaft twister requires a beefy motor to overcome the high detent torque and to ensure accurate positioning. For speed of operation a direct drive was used, the shaft driver being mounted directly on to one end of the motor shaft, and tacho and position transducers on to the other. The loop was completed with a power amplifier and a digital to analogue converter.

The screw adjuster is a smaller affair, being built into the specially constructed robot gripper. It uses a pseudo-stepper system in which a d.c. motor is wrapped in a control loop with two optical detectors arranged in quadrature. By selecting one of four optical signals, consisting of the two signals or their inverses, for feedback the motor can be made to step after the fashion of a stepping motor, but with a higher comparative torque. The optical system only required a metal butterfly to be attached to the motor shaft, with two slotted opto-switches mounted within the gearbox casing. A few more components allow the controlling computer to command the motor by outputting one of four bits.

A humble Commodore 4032 controls the

*(continued on next page)*

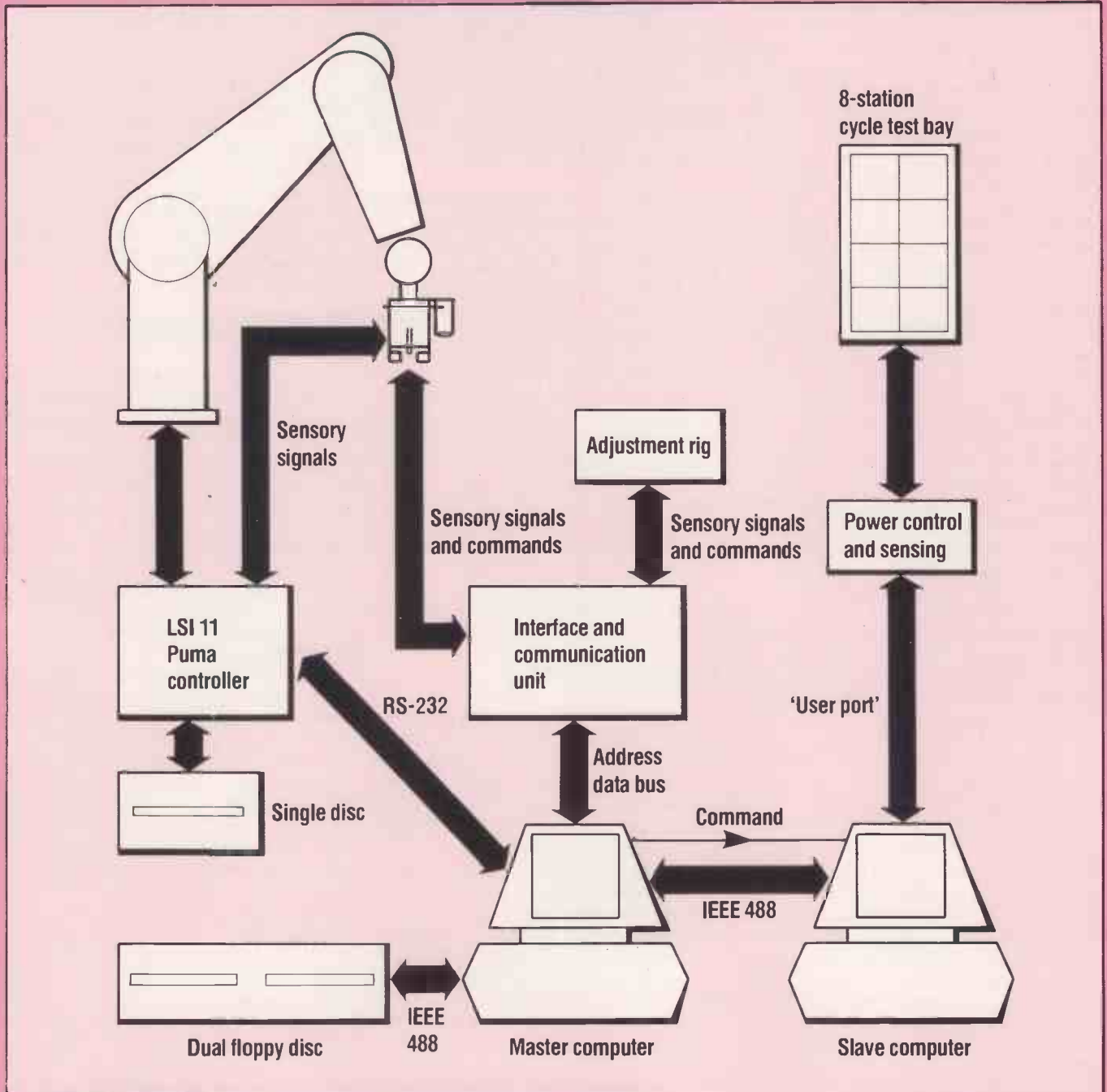

The Craftsman system as set up for adjusting a batch of energy regulators.

(continued from previous page)

adjustment strategy, the shaft rotator and the pseudo stepper, while monitoring switch closures and liaising with the Puma. An interface rack has been added to hold the servo controllers, a serial interface and such. Most of the signals to drive this are obtained via a ribbon cable attached to a header plugged into one of the empty ROM sockets. Most of the individual interface boards are centred on a 6522 versatile interface adaptor chip, much of the circuitry being concerned with maintaining opto-isolation between the computer and the rest of the system.

## Machine code

Speed-critical software is, of course, performed by machine-code routines. Because of the extensive documentation of the Commodore's inner workings, it is possible to weave these into the Basic structure, using the expression evaluator and a certain amount of parsing to streamline the structure. Thus a single command can have the effect of: Rotate clockwise at speed 20 to a limit of 60° or until the contact switch opens, returning the condition for halting in flag F. Arguments can be variables or numerical expressions, and if required a succession of manoeuvres can be chained together.

To test and modify the strategy a second Commodore 4032 is linked into the system, dedicated to performing a 100 percent test on all the regulators which have been adjusted. Similar machines and rigs are already employed for just that purpose in a factory near Portsmouth where the regulators are made. As statistical data is accumulated, the adjustment is made to adapt to give maximum probability of each regulator's performance falling within limits. The individual result is used to grade the regulator, instructing the robot to place it in the output tray or in the reject box. A faulty regulator must be allowed to cool before readjustment.

Experience with the system, which some months ago performed a 2,000-regulator test run, has suggested that much more can be deduced from the measurements made on each regulator. It is possible that messages could be passed upstream to an assembly robot to tell it not to be so heavy-handed, enabling the need for adjustment to be reduced.

Ideas on inspection theory are beginning to accumulate but each measurement which has to be made carries a certain cost. Some measurements are effectively free, being required for final performance checking. Others might be made to diagnose some point of difficulty. From the set of measurements, deductions can be made with varying accuracy about the state of each stage of the production. The aim is to maximise the quality of information in sensitive areas, while minimising the measurement cost.

With any practical project, the points of



The Puma arm has working parts above and below bench level.

detail offer every bit as much interest as the overall aim. The gripper, for instance, had to be designed to pick up the regulator in such a way that the screwdriver could always be accurately located on a rather elusive screw. Traditional grippers may have four moving fingers, some three, seldom less than two. After a false start, the gripper was designed with just one moving finger. This grips one corner of the regulator, while a fixed thumb holds the opposite corner. Both the finger and thumb have corner flanges to nestle the regulator securely. As the hand descends with the finger open, the arm is deliberately displaced to give equal clearance to finger and thumb. As the finger closes, the whole hand moves across to bring the thumb into action. Now the screwdriver has in the thumb a fixed reference point to locate the screw.

## Compliance

A further feature of the gripper is that power is used to open it rather than close it. When relaxed a spring holds the grip closed with sufficient force to ensure that the regulator does not slip. This gives the ultimate in compliance, ensuring that grip is not dimension sensitive.

A further refinement is a simple contact on the finger. If the finger closes too far, the computer can deduce that a regulator is not present and can move on at once to the next location. Checks can also be made that a regulator is being transported to and from the adjustment rig, and has not fallen out in transit. Another simple contact verifies that the regulator is comfortably seated in the rig.

After blowing a few fuses, it was clear that compliance was an important factor.

The whole adjustment rig is sprung upwards against the table and although normally rigid, if an impatient robot tries to ram an incorrectly held regulator into it, the whole unit springs downwards until the robot gives up. An equal danger was an attempt by the robot to place an adjusted regulator in the output tray, when another regulator had been left in the tray from an earlier experiment. The solution was to add robot vision.

Low-resolution systems have claimed to be cheap with resolutions of as few as 16 by 16 pixels. The Craftsman Robot system uses just one pixel, which can be swept by movement of the robot itself to grope for a misplaced object in much less time than is required for a human operator to intervene.

The technique is simple in this application. The underside of the output tray is illuminated. Regulators are deposited with their shafts pointing downwards through holes in the base of the tray. Thus if light can be seen shining through such a hole, it is safe to say that the position is empty. The hand approaches the tray with an offset to present the hand-mounted lens and photocell above the first hole. If this is dark, the hand moves on to the next at a rate of at least five locations per second. The regulator is deposited in the first vacant hole detected, and for succeeding regulators the search starts from the following hole.

## Cost comparison

When the system came to be adapted for installation in the factory, another problem became apparent. Two Commodore computers, disc unit, printer, shaft-rotation servo, screwdriver, mark-space test rig and all the interfaces can be purchased or constructed by the factory for under £10,000. They will perform the adjustment, log the results, adapt as necessary and signify any statistical trouble. The payback calculation indicates that the investment is well worthwhile. At over £20,000 the Puma can transfer the regulators from arrival tray to adjustment rig, then to cycle test bay and finally via a flash test to the output tray. A cost comparison against the use of a human operator looks much less favourable.

A Puma is of course a gross overkill for this application, but a low-cost robot with sufficient reach, repeatability and above all reliability might at present be hard to find. The layout is thus being arranged for alternative human or robot use, and if my predictions run true a suitable robot will be on the market within a year, at a price under £5,000.

There is a further worry from the project point of view. The experiments show that there is a danger that even our simpler strategies of adjustment are achieving accuracies better than the commercial market requires. If we are too successful we will have to look for a tougher nut to try out the sledgehammer. □

# KINGSLEY ENTERPRISES

Specialists in all kinds of floppy diskettes

Mail Order Discs  
Prices are for boxes of 10 discs

Soft Sector	Nashua	Xidex	Dysan	CenTech
5.25" Diskettes				
SS/SD.48	15.00	-	21.00	-
SS/DD.48	16.00	18.00	22.00	21.00
DS/DD.48	18.00	23.00	30.00	25.00
SS/DD.96	22.00	25.00	30.00	28.00
DS/DD.96	23.00	30.00	38.00	34.00
8" Diskettes				
SS/SD.48	20.00	-	25.00	-
SS/DD.48	21.00	22.00	29.00	29.00
DS/DD.48	22.00	26.00	33.00	33.00

Sony 3.5" (Apricot) Diskettes £36.00

Add carriage (£1 per box) and V.A.T. (15%)  
Prices correct at time of going to press  
Please ask for details of: hard sector discs,  
business/educational accounts,  
discounts, formatting.

**KINGSLEY ENTERPRISES**  
87 Whitefield Road  
Stockton Heath  
Warrington  
WA4 6NB

Organise your files on  
CenTech Colour  
discs

Tel: 0925 64207  
for 24 hour  
Dial-a-disc service

• Circle No. 188

## Is your computer bored with TV?

If you and your computer are still restricted by the confines of a television screen, Powertran robot kit could be the key that sets you both free.

Real programmable robots at an affordable price provide enthusiasts of all ages with an ideal introduction to the principles of computer control. Both robots come as self-assembly kits complete with instructions.

### MICROGRASP

A five-axis, servo controlled articulated robot arm for less than the price of a printer!  
Robot kit complete with power supply £215.00 + VAT  
Universal Computer Interface board kit £57.00 + VAT

### HEBOT II

A turtle type robot with independent 2-wheel drive, flashing 'eyes' and a two tone bleeper.  
Turtle kit £95.00 + VAT  
Universal Computer interface board kit £11.00 + VAT



Prices correct at time of going to press.  
Offers subject to availability.

**POWERTRAN**  
cybernetics  
limited



Portway Industrial Estate,  
Andover, Hants  
SP10 3PC

SALES DESK  
Telephone  
(0264)  
64455

• Circle No. 249

## Bring your computer alive with a Jessop Turtle – the radio-controlled robot.

The principle of teaching very young children fundamental computing through a Jessop Turtle has long been recognised and this view is endorsed by research at the Massachusetts Institute of Technology and at Edinburgh University and is already used in hundreds of British primary schools.

The abstract computer program becomes a visible, concrete reality, through the Jessop Turtle: quickly learned, easily assimilated and exciting to operate.

And two new sets of developments further enhance the Turtle to increase its capabilities and application as a teaching aid.

- The new remote radio-controlled Turtle (two-way to direct and confirm commands) is no longer restricted by an umbilical cord: and children cannot interrupt the process with their bodies as would happen with infra-red control.

- The availability of full Logos for the Sinclair Spectrum and the BBC micro will open up new worlds for Turtles – and their users. It will be possible to experiment with Turtle speech and vision without needing to learn a new language.

The Jessop Turtle has a whole range of uses:

- As an introduction to computing for children and adults: the logical, direct process allows quicker understanding of programs and

provides 'proof in action' for experimental programming.

- In the secondary school, it can provide low-cost, efficient entry to robotics. Its optical encoders, which tell the computer how far the Turtle has travelled or whether the pen is raised or ready to trace its path, are similar to those used in industrial robots.

- Secondary school students will turn the machine code program, used to control the Turtle, into the basis for a series of experiments and exercises in machine code programming and robotics.

- Because of its extreme accuracy, the Turtle can produce wall charts, maps and drawings.

- In the Jessop Turtle, not only is everything visible

through its clear 'shell', but the hardware and software is designed for further investigation.

- And the Turtle is being constantly upgraded: during the next year, you'll be able to add vision, speech and range-finding sensors to further your understanding of robotics.

The Jessop Turtle at a special summer discount price has never given better value. And a Turtle bought now can be enhanced, as developments occur, with conversion kits. (You can even convert your existing Turtle from umbilical cord to remote-control.) And Jessop Turtles can now be driven from Sinclair, Atari, Apple II, RML, Acorn/BBC, Commodore and IBM micros. Another reason why Jessop Turtles knock the spots off their rivals.

Please complete and return this coupon with your cheque for £182.27 (£155 + £3.50 P & P + VAT £23.77) to get your Jessop Turtle at the special Summer Offer Price. Schools & EA's need not send money: simply complete the coupon and return it with your official order.

Name .....

Address .....

### The Jessop Turtle

Jessop Microelectronics Limited, Order No. (Schools & EA's) or Cheque No. ....  
Unit 5, 7 Long St., London, E2.

What Micro do you have? .....

Disc or Cassette based? .....

Do you have Logo software? ..... YES/NO

PC6

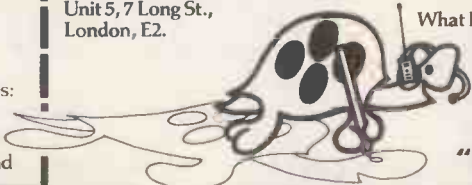

"Received and understood!"

• Circle No. 164

# The right software for your application from

## COMPUTECH

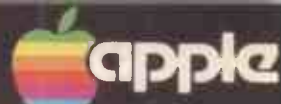

Authorised Dealer  
Service Centre  
System Consultancy



### COMPUTECH FINANCIAL ACCOUNTING PACKAGES

Payroll	£375
Invoicing and Stock Recording	£295
Sales, Purchases and General Ledgers	each £295
Also costing and group consolidation	

### COMPUTECH UTILITIES DISK

for reliable error checking copying, diskette scan, interpret and patch, etc £20  
VisiCalc, Applewriter and other Apple software (Prices on request)

### COMPUTECH CHAIN MAIL

A mailing merging document processor which may be used with text files, including random files and Applewriter 1.1 binary files £45

### COMPUTECH GRAPHICS DISK

for printing Apple pictures and graphs on Epson and Microline (free with printers purchased from Computech) £30

### COMPUTECH TERMINAL UTILITIES

Apple to Apple and Apple to mainframe from £130

## COMPUTECH hardware...just plug it in and go!

switches and jumpers provide hardware options without soldering



### DIPLOMAT VIDEO DIGITISER

store a frame from video camera in a fiftieth of a second, process and print — for Apple II £195  
for APPLE II/e, including 64K Extended 80 Column Card £345

DIPLOMAT PARALLEL Interface £80

DIPLOMAT SERIAL COMMUNICATIONS Interface £85

DIPLOMAT RAM 16 Memory Expansion £95

DIPLOMAT CLOCK/CALENDAR £80

LOWER CASE Character Generator with Applewriter 1.1, enhancements £50

MICROMUX Data Exchange (Max 16 Ports) from £850

MATRIX PRINTERS, Microline and Epson with graphics and up to 200 cps from £222

MICROLINE Optional Character Generator £15

DAISY WHEEL PRINTERS, Olympia, Qume, Ricoh from £798

Prices exclude VAT, Carriage and Packing

For full details phone for data sheets and a FREE demonstration

## COMPUTECH SYSTEMS

168 Finchley Road, London NW3 6HP. Tel: 01-794 0202

## DOT MATRIX PRINTERS



ALL PRINTERS HAVE CENTRONIC PARALLEL INTERFACE UNLESS OTHERWISE STATED. ALL PRINTERS HAVE HI-RES. DOT ADDRESSABLE GRAPHIC MODE. PLEASE SEND SAE FOR FULL DETAILS.

**EPSON**  
 FX 80 160 CPS, 10" wide fric & pin feed £344 - VAT £395  
 FX 100 160 CPS, 15" wide fric & tract feed £431 - VAT £485  
 RX80 FT 100 CPS 10" wide fric & tract feed £261 - VAT £299  
 RX80T 100 CPS, 10" wide tractor feed £234 - VAT £269  
 LQ1500 200 CPS Letter quality printer £29 - VAT £33  
 8143 RS 23 interface for FX and FX printers £60 - VAT £69  
 8148 RS232 interface with 2K buffer xon/xoff Ribbon Cartridge for RX80 FX80 & MX80 £17 - VAT £17  
 Ribbon Cartridge for FX 100 & MX100 £13

**STAR**  
 Gemini 10X 120 CPS, 10" wide fric & tract feed £200 - VAT £229  
 Gemini 15X 120 CPS, 15" wide fric & tract feed £295 - VAT £339  
 Delta 10 160 CPS, 10" wide fric & tract feed £327 - VAT £375  
 Delta 15 160 CPS, 15" wide fric & tract feed £414 - VAT £475  
 Radix-10 200 CPS NLO 16K Buffer Par & serial interface, downloadable characters, incredible value at £431 - VAT £495  
 Radix-15 15" wide version of Radix-10 £518 - VAT £595

**SEIKOSHA**  
 GP100A 50 CPS, 10" wide, tractor feed £156 - VAT £179  
 GP250 50 CPS, 10" wide, fric feed ser & par £196 - VAT £225  
 GP100VC 30CPS 10" wide VIC 20 & 64 interf £174 - VAT £199  
 GP500A 50 CPS, 10" wide tractor feed £187 - VAT £215  
 GP550A 50 CPS, 10" wide fric & tract correspondence quality £234 - VAT £269  
 GP100AS Serial interface ideal for Spectrum with microdrive £174 - VAT £199

**SHINWA**  
 CP80 80 CPS, 10" wide fric & tract feed £187 - VAT £215  
 Spare ribbon cartridge for CP80 £6 - VAT £6

**RITEMAN**  
 Compact 120 CPS, 80 col fric & tract feed £200 - VAT £229

**CANON**  
 PW1080A 160 CPS, 10" wide, 27 CPS NLO 24 x 16 matrix £283 - VAT £325  
 PW1156A 160 CPS, 15" wide, 27 CPS NLO 24 x 16 matrix £347 - VAT £399

**COLOUR PRINTERS**  
 Seikosh GP700A 7 colour, 50 CPS printer £347 - VAT £399  
 Canon PJ1090A 7 colour, 40 CPS ink jet printer £391 - VAT £449  
 CPP40 40 column 4 colour battery operated £118 - VAT £135

ALL OUR PRINTERS HAVE 1 YEAR WARRANTY

## BBC MICROCOMPUTER SYSTEM

WE ARE AN OFFICIAL BBC COMPUTER DISTRIBUTOR  
 DEALER ENQUIRIES ARE WELCOMED

## Acorn Electron £199 INC VAT

WE SUPPLY FREE 30 HOUR BASIC BOOK AND A DUST COVER WITH EACH COMPUTER

This is the best microcomputer currently on the market. 32K RAM, 32K ROM, 8 modes of operation, full colour, full-size keyboard, internal expansion slots such as disc interface, speech synthesiser, Econet interface. In short it is a personal computer capable of expanding into a small business system.

BBC Microcomputer Model B £348 - VAT £399  
 BBC Mod B - disk interface £409 - VAT £469  
 BBC Mod B - Econet interface £389 - VAT £447  
 BBC Mod B - disk and Econet interfaces £450 - VAT £517  
 BBC 100K disk drive £230 - VAT £264  
 BBC dual 800K disk drive £699 - VAT £803  
 Torch Z80 disk pack including Z80 2nd processor, 64K RAM and CPN operating system - Free Perfect Software £686 - VAT £799  
 BBC Teletext receiver (Aug) £196 - VAT £225  
 BBC cassette recorder and lead £26 - VAT £29  
 Disk interface kit (free fitting) £84 - VAT £96  
 Mod A to Mod B upgrade kit £70 - VAT £80  
 Fitting charge for A to B upgrade kit £20 - VAT £23  
 16K memory upgrade kit £30 - VAT £34  
 £11 - VAT £12  
 12" Monochrome monitor incl cable £89 - VAT £102  
 14" Colour monitor incl cable £195 - VAT £222  
 User guide £10 - VAT £10  
 Econet interface (free fitting) £60 - VAT £69  
 Speech interface (free fitting) £47 - VAT £54  
 BBC disk manual - formatting disk £30 - VAT £34  
 Parallel printer cable £10 - VAT £11  
 BBC word processor (view) £52 - VAT £59  
 BBC Fourth language cassette £15 - VAT £17  
 BBC LSP language cassette £15 - VAT £17

APPROVED ECONET SERVICE CENTRE  
 WE STOCK A LARGE RANGE OF SOFTWARE FOR BBC MICRO INCLUDING ACORN'S OWN BBC SOFTWARE LONGMANS SOFTWARE PLEASE SEND LARGE STAMPED ADDRESSED ENVELOPE FOR FULL DETAILS

## TORCH Z80 2nd PROCESSOR For only £347 + VAT

Torch 2nd Processor Z80 is supplied with perfect writer (a powerful Word Processor), perfect spell checker (spelling checking program - I should have used one for making this advert!), Perfect File (A Database Program), Perfect Calc (Spread Sheet). It includes 64K memory (Almost 60K available to user) Fits inside BBC Computer

Z80 2nd Process - Perfect Software £347 - VAT £399  
 Z80 Processor - Perfect Software - Dual 800K Disk Drives £695 - VAT £799

## GUARANTEED LOWEST PRICES

### 100% BBC COMPATIBLE MITSUBISHI AND TEAC SLIMLINE DISK DRIVES

#### NEW LOWER PRICES!



These drives are supplied ready cased with all the necessary cables, formatting program and User Guide. There are some very useful utilities included on formatting disc e.g. DISASSEMBLER. This is 6502 machine code disassembler. DUP - To copy and rename a file on disc. FORMAT - Formatting program for 40 & 80 tracks. FREE - This utility provides a disk usage analysis. MDUMP - Enables you to display and modify any part of BBC memory. MERGE - Merge a number of text files into one file. RELOCATE - Downloads a basic program to 800. SDUMP - Screen dump for EPSON in all graphic modes. VERIFY - Verifies every sector on a disk. MENU - A flexible menu program.

Single drive 100K 40 trks single sided £147 - VAT £169  
 Dual drive 200K 40 trks, single sided £286 - VAT £329  
 Single drive 200K 40 trks, double sided £173 - VAT £199  
 Dual drive 400K 40 trks double sided £330 - VAT £379  
 Single drive 400K 80 trks, double sided £199 - VAT £229  
 Single drive 400K 40/80 trks, switchable DS £217 - VAT £249  
 Dual drive 800K 80 trks, double sided £382 - VAT £439  
 Dual drive 800K 40/80 trks switchable DS £408 - VAT £469

All above drives are low power slimline (0.3 A typ at 12v and 0.4 A at 5v per drive). Normally extra power supply is not required the BBC Computer power supply is designed to drive two low power drive (IT IS NOT DESIGNED TO DRIVE INTERNAL ROM BOARD)  
 40 Track SS/DD diskettes (10 Box) £18 - VAT £20  
 40 Track DS/DD diskettes (10 Box) £23 - VAT £26  
 80 Track SS/DD diskettes (10 Box) £28 - VAT £32  
 80 Track DS/DD diskettes (10 Box) £30 - VAT £34  
 ALL ABOVE DISKETTS ARE CERTIFIED EITHER MEMOREX OR DETALIFE

## YOUR CONTACTS AT AKHTER ARE

DEALER/BULK ENQUIRIES HAMAYUN MUGHAL  
 TELEPHONE ORDERS PAULA HAYES  
 DEALER ORDERS TONY GLOVER  
 BUSINESS SYSTEMS ENQUIRIES DENNIS SUTCH  
 EXPORT ENQUIRIES MAHAMAD EDIB  
 ECONET SYSTEM TECHNICAL ENQUIRIES ALAN LAFFOLEY  
 ACCOUNTS CARON ANDREWS  
 DESPATCH PAUL SWIFT  
 REPAIRS JOHN MAULE

## BUSINESS SYSTEMS



### APRICOT - SIRIUS - SANYO IBM - TEXAS - TORCH

**APRICOT** "Portable Executive Computer", 16 Bit Micro, 256K RAM, up to 1.44 megabytes floppy disk storage, 3 1/2" Sony disks. Portable brief case styling. Modem with auto dialler (optional) hard disk optional. Vast software library (compatible with Sirius 1)  
 Apricot with Single Drive and Monitor £1690 + VAT  
 Apricot with Double Drive and Monitor and Free Printer or 2nd Monitor £1890 + VAT

**SANYO PROFESSIONAL COMPUTER**  
 16 Bit Micro 128K RAM expandable to 256K. Single or Double Disk Drive built in full colour graphics (640 x 200 pixels in 8 colours) IBM compatible. Free software. Sanyo MBC 550 128K RAM single drive and free software including Wordstar and Calcstar £749 + VAT  
 Sanyo MBC555 128K double drive and free software including Wordstar, Calcstar, Infostar Dastalar etc £999 + VAT

**SIRIUS 1** Sirius 1 Computer with 128K RAM and 1.2 megabyte Floppy disc storage including CP/M 86, MS DOS and Microsoft Basic £2195 + VAT

Sirius 1 Computer with 256K RAM and 2.4 megabyte Floppy disc storage including C/M 86 MS DOS & Microsoft Basic

**TORCH**  
 CP500 COMPUTER with colour monitor includes Twin 400K disks, Torchnet Operating System free perfect software (perfect writer, perfect spell checker, perfect calc perfect filer), Torchmail Plus (Electronic Mail), Torch Mars (Financial modelling with graphics), Torchfile (Viewdata Access System) Executive Aid (Menu System)  
 Datal 600 (Link to outside mainframe services i.e. Jumbal Telecom Gold) £2950 + VAT

**TEXAS INSTRUMENTS PROFESSIONAL COMPUTER**  
 TI 502 Dual 320K Drives 256K RAM. Up to 10 megabyte on board storage possible. TI speech command hardware option brings a new level of user friendliness to computing. Allows voice operated keyboard control (Optional). Price £2650 + VAT

MAINTENANCE CONTRACTS ARE AVAILABLE.

## COMPLETE WORDPROCESSING SYSTEMS INCLUDING DAISYWHEEL PRINTER From £695 + VAT



**SYSTEM 1** BBC Micro model B, Wordwise, Phoenix monitor, Smith Corona T1 Daisywheel Printer, Cassette Recorder - all the necessary cables and documentation £695 - VAT - £799.25

**SYSTEM 2** BBC Micro model B - Disk Interface, Phoenix Monitor, 100K Single Disk Drive, Wordwise, Smith Corona Daisywheel Printer - all the necessary cables and documentation Price only £895 + VAT = £1029.25

**SYSTEM 3** BBC Micro model B - Disk Interface, Phoenix Monitor, Dual Disk Drives 200K, Wordwise, Smith Corona Daisywheel Printer - all the necessary cables and documentation Price £999 + VAT = £1148.85

**SYSTEM 4** BBC Micro model B - Disk Interface, Sanyo High-Res Green Monitor, Wordwise (or view), Juki 6100 Daisywheel Printer, Sanyo 400K Disk Drive - all the necessary cables and documentation £1049 + VAT = £1206.35

**SYSTEM 5** BBC Mod B Micro - Disk Interface, Sanyo High Res Green Monitor, Wordwise (or view), Juki 6100 Daisywheel Printer, Dual Disk Drive 800K - all the necessary cables and documentation Price £1195 - VAT = £1374.25

**SYSTEM 6** Sanyo 16 Bit, IBM pc Compatible Micro, 128K RAM, Single Disk Drive 160K, Wordstar, Calc Star, Sanyo High Res Green Monitor, Juki 6100 Daisywheel Printer - all cable and documentation Price Only £1145 + VAT = £1316.75

**SYSTEM 7** Sanyo 16 Bit IBM pc Compatible Micro 128K RAM, Dual Disk Drives 360K, Wordstar, Calc Star, Malminger, Infostar, Spelstar Dastalar, Sanyo High Res Green Monitor, Juki 6100 Daisywheel Printer - all necessary cables and documentation, Price £1395 + VAT = £1804.25

**SYSTEM 8** All the components of System 6 but with Sanyo High Res Colour Monitor and Wordstar with Colour Facilities. Price £1445 + VAT = £1661.75

**SYSTEM 9** All the components of System 7 but with Sanyo High Res Colour Monitor and Wordstar with Colour Facilities. Price £1695 + VAT = £1949.25

WE CAN ALSO SUPPLY PACKAGES WITH COMPONENTS OF YOUR OWN CHOICE. PLEASE PHONE (0279) 443521 AND ASK FOR HAMAYUN MUGHAL FOR A PRICE.

## DAISYWHEEL PRINTERS

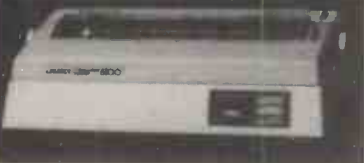

**JUKI 6100**  
 20 CPS Bi-Directional Logic seeking 10,12,15 CP1 - PS Spacing 2K buffer bed setting Daisywheel Single sheet feeder unit £349 - VAT £395  
 Tractor Unit £217 - VAT £249  
 RS 232 interface £52 - VAT £59  
 Spare Daisywheel £17 - VAT £19

**BROTHER HR-15**  
 13 CPS Bi-directional 10 12 15 CP1 - PS Keyboard Unit £344 - VAT £395  
 Single Sheet Feeder Unit £217 - VAT £249  
 Tractor Unit £95 - VAT £109

**DAISY STEP 2000**  
 20 CPS Unidirectional, 10 12 15 CP1 £260 - VAT £299

**SMITH CORONA TP1**  
 12 CPS 10 12 CP1 unidirectional £208 - VAT £239

## PROFESSIONAL MONITORS

\*SANYO  
 \*MICROVITEC  
 \*FIDELITY  
 \*PHOENIX

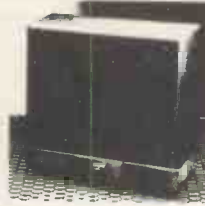

**SANYO**  
 DM8112 12" Green screen 18 MHz Hi-Res £86 - VAT £99  
 DM2112 12" Green screen 15 MHz Monitor £66 - VAT £75  
 CD3125 14" RGB Normal Res Colour Monitor £173 - VAT £199  
 CD3117 14" RGB Medium Res Colour Monitor £286 - VAT £329  
 CD3115 14" RGB-High Res Colour Monitor £391 - VAT £449

**MICROVITEC CUB**  
 1431 MS 14" RGB Normal Res Colour Monitor £173 - VAT £199  
 1451 MS 14" RGB Medium Res Colour Monitor £321 - VAT £369  
 1441 MS 14" RGB High Res Colour Monitor £417 - VAT £479

**FIDELITY Colour Monitor**  
 CM14 14" RGB RGBY Composite sound col £187 - VAT £215

**PHOENIX**  
 Phoenix High Res 12" Green Monitor £66 - VAT £75  
 Phoenix High Res 12" Amber Monitor £69 - VAT £79

AKHTER INSTRUMENTS LTD T A



## COMPUTER GROUP

28/29 BURNT MILL  
 HARLOW, ESSEX. CM20 2HU U.K.  
 Tel. HARLOW (0279) 443521 Telex: 818894 AKHTER G

## ORDERING INFORMATION:

We accept official orders from UK Government and Education establishments. Carriage is Free (UK only) for normal delivery. If express delivery is required please add £8.00 + VAT per parcel. We accept telephone orders on Barclay and Access Card please ring (0279) 443521 (10 lines). All cheques made payable to "AKHTER INSTRUMENTS".

N.B. ALL VAT INCLUDED PRICES ARE THE CORRECT PRICES. EXCL. VAT PRICES HAVE BEEN ROUNDED UP TO NEAREST POUND.

OPENING HOURS: MON-FRI 9am-6.30pm, SAT 10am-5pm  
 We welcome callers, no parking problems.



# BIG SAVINGS ON

# Commodore Business Computer Systems



Adda Computers, London's leading Commodore dealer is offering a very special 'package deal' for Business. This is your opportunity to get the hardware, software and peripherals that your company needs at an enormous saving.

We've packaged two systems to cover every size of business. And each system is complete with SUPERSCRIPT word processing, SUPERBASE filing system and the CALC RESULT spreadsheet program.

Come along to Adda and see the business systems and software on offer being demonstrated. We will also show you how, by adding the hugely successful PEGASUS accounting system, you can rapidly transform your business accounting procedures, speeding up invoicing, improving stock control, reducing outstanding balances and providing regular management accounts.

**If all this is not enough – if you are within 25 miles of our West London offices we will, FREE OF CHARGE, deliver and install the system, give one days introductory training and provide warranty service on-site. This offer gives you an ADDITIONAL SAVING OF UP TO £275! (If purchased before 31st August, 1984.)**

CALL US TODAY ON  
01-997 6666  
or return the coupon  
for further details.

# adda

710B computer with 128KB of memory, integral swivel tilt monitor and detachable keyboard, 8250 dual floppy disk drive with 2 megabytes of disk storage capacity and the 1361 high speed dot matrix printer, plus cables, plugs and 3 software packages (Superscript word processing, Superbase filing system and Calc Result spreadsheet).

Normally £3,484\*  
Now £1,995

**YOU SAVE £1,489**

710B computer with integral monitor, 8250 dual disk drive, 6400 daisy wheel printer, plus cables and 3 software packages (as above).

Normally £3,854\*  
Now £2,495

**YOU SAVE £1,359**

\*When bought as separate items

All prices exc. VAT.

To: Adda Computers Ltd., Unit 8, 1-7 Broomfield Road,  
West Ealing, London W13 9AP.

Please send me details of the Commodore 700 special offers.

I am interested in:  Accounting  Word processing  Database  
 Spreadsheet

● Circle No. 250

Name \_\_\_\_\_

Title \_\_\_\_\_

Company \_\_\_\_\_

Address \_\_\_\_\_

Tel. No. \_\_\_\_\_

# MINSTREL Turbo

real multi-user networking that offers so much more



## Networking

Each user has their own 8- or 16-bit computer, networked together inside the Minstrel, to run CPIM-80 or CPIM-86 compatible software.

## Compatibility

Record-locking compatibility with MPIM means standard multi-user languages and packages are suitable for Minstrel TurboDOS systems.

## Expandability

Using the ARCNET local area network up to 256 Minstrels of up to 6 terminals each may be linked together. Each Minstrel system may have up to 160Mb of Winchester storage.

## Sophistication

The Minstrel Turbo is a true networking system with resource sharing. Up to 9 spooled printers per Minstrel are accessible from any processor.

## Versatility

A Winchester drive and 5" floppy disk drive are standard, 8" floppy drives are optional, as are tape cartridge drives, and IBM and ICL mainframe communications.

## Telex

The Minstrelex package adds telex facilities to the Minstrel Turbo and features automatic send and receive, call logging, conversation modes.

### Prices/Details

2-user system with:  
20Mb Winchester  
800Kb floppy  
3 Z80A processors  
connection cables  
KDS7362 VDUs  
TurboDOS  
Operating System **£5625**  
+ VAT

5-user system with:  
40Mb Winchester  
tape cartridge back-up  
800Kb floppy  
6 Z80A processors  
connection cables  
KDS7362 VDUs  
TurboDOS  
Operating System **£11160**  
+ VAT

**HMSystems**  
**HMSystems Limited**

69 Loudoun Road, London NW8 0DB  
Telephone: 01-328 8737/8  
Telex: 266828

# Commodore boom

As more and more games for the 64 hit the market, Jack Schofield laments their lack of originality but manages to find some that look like winners.

THE NUMBER of good Commodore 64 games has exploded in the last few months. As usual, and to everyone's disgust, very few show much original thought. In fact, with honourable exceptions like Commodore International Football and Jeff Minter's deservedly popular creations, the 64 seems to attract little more than conversions from the Spectrum and the Atari. However, every month there's at least one humdinger written for the 64, works well on the 64, and makes some use of its facilities. This month's prize winner is...

## Dinky Doo

Behind the very silly name there is a very silly game from a very smart company, Software Projects. You are a balloon-shaped fellow similar to the alien in the movie *Dark Star*, and your task is to waddle over to a get a glass of hot milk. Unfortunately you have to do it by negotiating a maze of electrified fences, while avoiding ghosts, skulls, fast-moving snakes, barriers and other nightmarish nasties. When you reach the milk, the nasties are transformed into cherries, and you score points by touching them on your way to the fridge.

Software Projects had a big hit on the Spectrum with *Manic Miner*, of which there is now a version for the 64. *Dinky Doo* is a different game altogether, but there are some similarities. Both contain lots of imaginative little characters you have to avoid. Both rely on you getting lots of practice, because your timing has to be just right to get through the different screens. Both are compulsive, since although it is fairly easy to work out what you have to do, doing it is difficult. Finally both end up with the player screaming "Aaargh!" and bashing their head on wall.

*Dinky Doo* is better than *Manic Miner* in a number of ways. It has faster, smoother action; cleaner, brighter graphics, and a compulsive musical accompaniment. Altogether just what you would expect from a Commodore 64 game, and rarely get.

An added attraction is that while



Chinese Juggler from Ocean simulates the well-known circus trick.

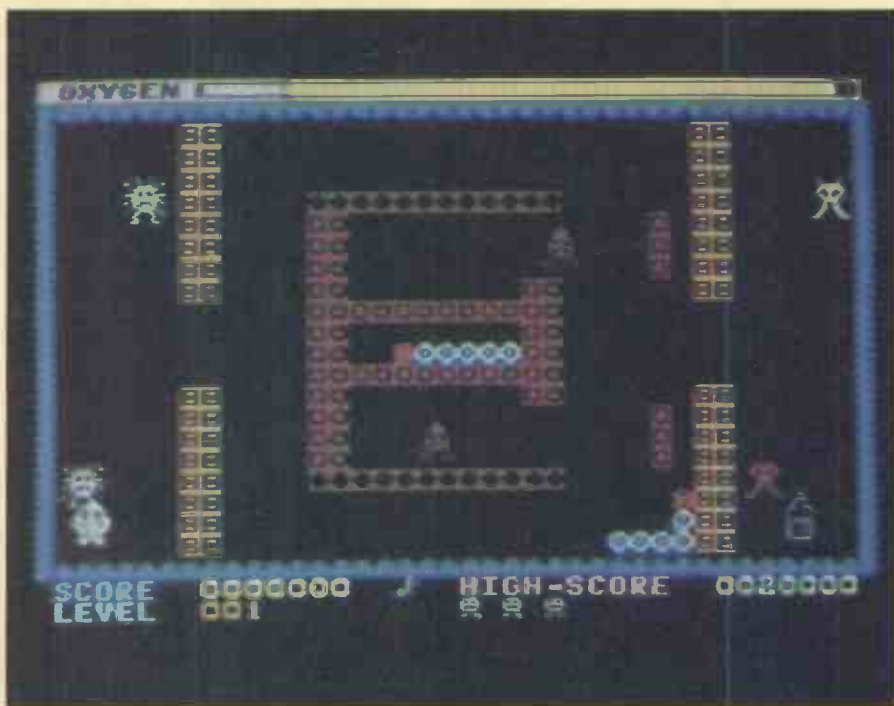

Dinky Doo — the silly name needn't stop it being a success.



loading, the tape provides a display of Spectrum-style pyrotechnics with a musical accompaniment, so at least you know something is happening. It makes a nice change from hours spent staring into the hazy blue yonder.

Well done, Damien McComb. This should be a big winner.

## Splat!

The title of this cassette from Incentive is onomatopoeic: it is what happens when you run into a wall, whereupon pink globules fly in slow motion in four

directions, and you are turned into strawberry jam. Apart from that Splat! has very little to recommend it in the way of sound or graphics. Nonetheless it is another compulsive game, which will have you saying "just one more" long into the night.

Splat! is diagrammatic. You are a little cursor and have to scoot about inside a moving maze eating grass and plums to gain points. You move about using the keyboard — define your own keys — or a joystick, which gives all the control of a double-decker bus on a skidpan.

When you have completed a screen, a synthesised voice shouts "Whoopie!"



Centipede — last seen on Ataris.

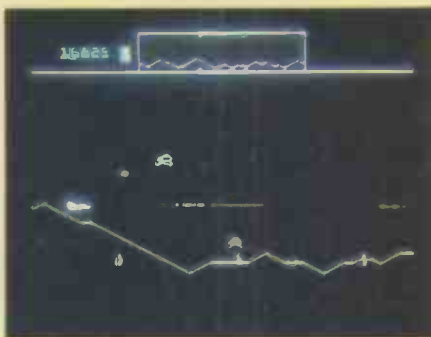

The vicious Defender.

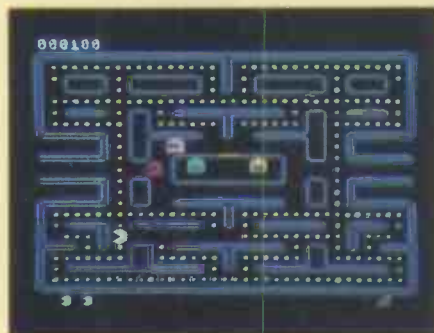

Fun for all ages with Pacman.



Robotron's crowded screen.

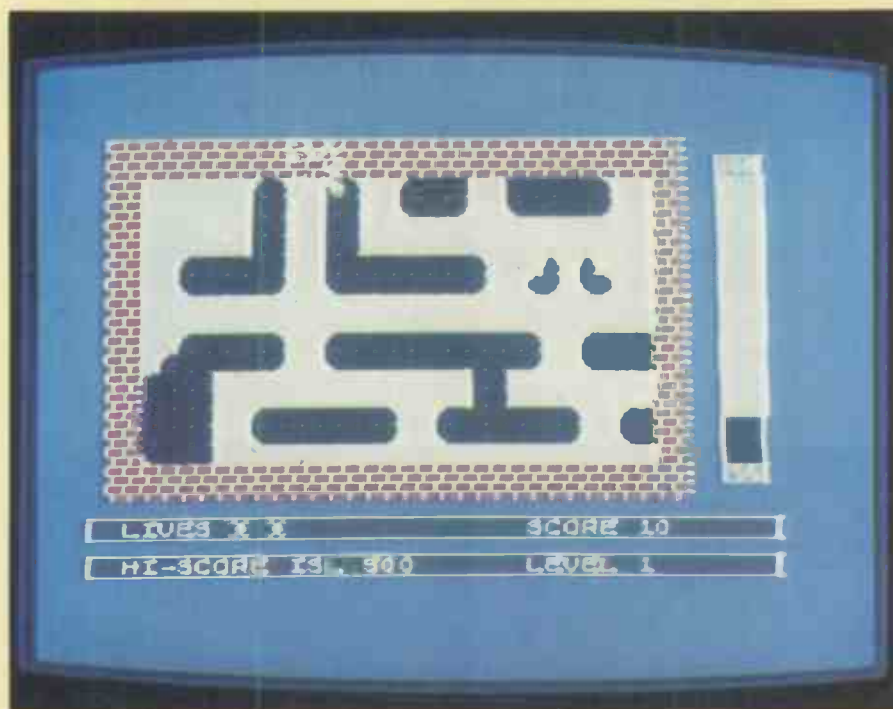

Avoid becoming strawberry jam in Splat!, a conversion from the Sepctrum.

and you go on to the next level. There are supposed to be seven levels with an exit on level 7, but you will have to take Incentive's word for it.

There is a High Score table, and you get a code number for your highest score so you can write in to Incentive and claim your prize in its Splat! competition.

Splat! has been available for some time on the 48K Spectrum, but it is none the worse for that.

## Centipede

Moving from Spectrum derivations to Atari derivations, the best of the first batch is Centipede on ROM. There are about eight rip-off versions of this ancient — circa 1980 — arcade favourite, but the Atarisoft is the first I have tried that comes anywhere near the original. In fact, it comes as close as you could expect on the Commodore 64.

Compared with the Atari computer version the fleas dive more slowly, and the spider is less vicious. Also, as with all the Atarisoft programs, the handbook is much smaller and less comprehensive. But these are minor complaints. The colours are bright, the action is fast and the sound is compelling. All round this remains one of the best one- and two-player family arcade games.

## Pacman

The other great family arcade game, in that it offers a two-player option and can be enjoyed by even very young children, is Pacman. Again the Atarisoft version has many rip-offs to compete with, and is far superior to all those I have seen. Again it is marked by its bright colours, smooth action and compelling sound.

Overall it seems better than the Atari home computer original, being more like the more recent Atari Ms Pacman.

Recommended.

## Defender

This is definitely not a family arcade game. At its best it is vicious, horrifyingly fast and compelling to the point of insanity — I have the broken joysticks and callouses to prove it.

Like the Atari version it is also on ROM, has a two-player option, and offers three levels of difficulty. Unfortunately the Commodore 64 version is not as good as the arcade game, or the Atari original, or even Planetoids on the BBC Micro. Movement is slower, the chasers and bombers are feeble, the mutants and swarms less threatening, the landers slow and highly unlikely to prove fatal unless you run into them by accident, and shooting landers is like popping balloons.

While the colour is good, the sound effects are well below par and you get no

(continued on page 139)

# SERIOUS DECISIONS NEED THE SUPPORT OF OUR 80 COLUMNS



Most serious users of micro computers require the facility to display in 80 columns, especially for word processing. Try this on most monitors and the result will be a frustratingly fuzzy image.

The Microvitec CUB 653 gives the user not only glowing colour, but also pin-sharp images, thanks to a medium resolution screen 653 pixels wide by 585 high, plus a selective transmission

panel giving super-high contrast. These features make this model from the CUB range of monitors the perfect partner for the high resolutions generated by BBC B, SINCLAIR Q.L., I.B.M.,

MICROVITEC  
**cub**  
COLOUR DISPLAYS

ELECTRON, ORIC, APPLE II and IIe, and many others.

So if you wish to sharpen your image, whether in the office or at home, decide Microvitec:

**Remember—the highest quality doesn't have to mean the highest cost.**

*Call at your local dealer or contact us direct and we'll send you full details with a pleasant surprise — our price list.*



Microvitec PLC., Futures Way, Bolling Road, Bradford, West Yorkshire, BD4 7TU. England. Tel: (0274) 390011 Telex: 517717

Microvitec Monitors are available from your specialist local computer dealer, selected branches of W. H. Smith, John Lewis Partnership, Lasky's, John Menzies, Greens at Debenhams and other leading retailers.

(continued from page 137)

real whoosh as things materialise. Worse still, the radar view, which is the key to high scores at Defender, is almost useless.

The Atarisoft Defender is probably one of the best games available on the Commodore 64. However, it is not nearly as good as the Atari home-computer version, and not even as good as the Atarisoft one for the Vic-20.

## Robotron: 2084

A fast, complex, ROM-cartridge game where the screen is so crowded it's hard to see what is going on. It does not get any easier even if you read the instructions. Definitely one for the arcade addicts of the original Williams game.

## Americana

Although they are too well-known to need reviewing, some of the best American games are now available for the Commodore 64. First and probably best is the Zork trilogy of adventure games from Infocom, available from Commodore. The famous Sublogic Flight Simulator II, previously available as the Microsoft Flight Simulator for the IBM PC, has now made it on to the

	Publisher	Format	Price	Rating
Bumping Buggies	Bubble Bus	tape	£6.99	6/20
Centipede	Atarisoft	ROM	£19.99	17/20
Chinese Juggler	Ocean	tape	£6.90	9/20
Defender	Atarisoft	ROM	£19.99	15/20
Dinky Doo	Software Projects	tape	£7.95	18/20
Pacman	Atarisoft	ROM	£19.99	16/20
Robotron: 2084	Atarisoft	ROM	£19.99	15/20
Splat!	Incentive Software	tape	£6.50	14/20
Triad 64	Live Wire	tape	£8.95	11/20

Commodore 64 as well as the Apple II. Your dealer should be able to obtain it via a distributor such as Softsel. Synapse has a 64 version of last year's biggest hit on the Atari in the Datasoft line-up, Zaxxon, but I still prefer Synapse's own Blue Max. Finally, Atarisoft now has a 64 version of Dig Dug.

## Also-rans

Chinese Juggler, from Ocean, is a computer simulation of that curious circus pastime of spinning plates on the end of sticks. It is beautifully animated and an excellent demonstration of the 64's graphics capabilities. As a game it is quite playable, but not particularly exciting and hardly compulsive. To be honest, it's actually pretty boring.

Another game which is also available on the Sinclair Spectrum.

Bumping Buggies, from Bubble Bus, is not available on the Spectrum, but it

ought to be. It is the type of jerky, trivial, stupid game that seems to thrive on Uncle Clive's machine. You get an aerial view of a sort of racetrack, and use a joystick to steer a small car. The car can jump and bump other little cars also on the track. It is all very uninspiring, and perhaps it gets better as it goes on but I doubt it.

Triad 64, from Live Wire, is a kind of three-dimensional skittles, except the skittles are fierce-looking enemy fighters which come down the screen towards you. You shoot them down with large white blobs which are the equivalent of the balls used in 10-pin bowling. The best feature of the game is the gun sight, which is three-dimensional and similar to something out of *Star Wars*. At the height of the action, which is fast and furious, it dances about the screen.

Triad 64 is not a great game. It lacks the precision and finesse which make classics like Defender and Star Raiders immortal.

**“So what's so special about it?”** The price is, for a start. You'd normally have to pay much more for a robust, high quality 22 cps correspondence printer with the sort of facilities the RPI200 offers; facilities usually found on much more expensive printers. **“Like what, for example?”** Like a Double Daisywheel. Like a choice of friction or tractor feed and paper handling devices. **“Supposing I don't like the typeface?”** No problem. A wide variety of typefaces is available plus foreign language versions, scientific symbols and Teletex. **“What if my staff don't like it?”** They will. The printer is quiet, but solidly built. And the print wheels and cassettes are quick and easy to change. **“Will it work on my computer?”** It's been designed to talk to most but talk to us to find out just how fluent it is.



**APTEC RPI200.**  
Your special correspondent



**APTEC**

Very Appropriate Technology

PERIPHERALS SALES DIVISION  
APPROPRIATE TECHNOLOGY LIMITED  
2-4 Canfield Place, London NW6 3BT.  
Tel: 01-328 7272. Telex: 261797 APTEC G.

LOOK WHAT YOU  
MISSED IN BEEBUG  
VOLUME TWO

# BBC MICRO - USER SUPPORT -

● 10 ISSUES OF BEEBUG MAGAZINE MAILED FREE TO MEMBERS ● 30  
EXCITING GAMES AND VISUAL PROGRAMS ● 43 SOFTWARE REVIEWS ● 33  
HARDWARE REVIEWS ● 16 BOOK REVIEWS ● 150 HINTS AND TIPS ● 25  
APPLICATION PROGRAMS ● SERIES OF ARTICLES FOR BEGINNERS ● MANY  
ADVANCED TECHNICAL ARTICLES ● NEWS AND PRODUCT INFORMATION  
● PLUS SPECIAL OFFERS ● BIG DISCOUNTS ON A WIDE RANGE OF  
PRODUCTS ● EVENTS ● BRAIN TEASERS ● LOCAL CLUBS ● FULL  
MAGAZINE INDEX

## A YEARS SUBSCRIPTION WOULD HAVE BOUGHT YOU ALL THIS

*Figures based on the 10 issues of BEEBUG Volume 2.*

## BUT IT'S NOT TOO LATE TO JOIN FOR VOLUME THREE

BEEBUG PUBLICATIONS LTD. PO BOX 109, HIGH WYCOMBE, BUCKS

PLEASE ENROL ME FOR VOLUME 3 of BEEBUG AT £9.90 (10 ISSUES)

NAME .....

ADDRESS .....

..... AMOUNT ENCLOSED .....

BEEBUG HAS BEEN ESTABLISHED  
FOR TWO YEARS AND NOW HAS  
OVER 25,000 MEMBERS. IT OFFERS  
TOTAL USER SUPPORT TO ALL BBC  
MICRO USERS.

PLEASE MAKE CHEQUES MADE PAYABLE TO BEEBUG PUBLICATIONS LTD.  
AND SEND TO:- DEPT 5 PO BOX 109, HIGH WYCOMBE, BUCKS.  
(DISTRIBUTION AGENTS FOR BEEBUG)

● Circle No. 167

# StarBASE... a new database



# StarBASE... for the BBC

STOCK SUBJECT TO PRIOR SALE

Local authority enquiries welcome.  
Prices correct at time of going to press.



GCC (Cambridge) Limited  
66 High Street, Sawston, Cambridge CB2 4BG  
Telephone: Cambridge (0223) 835330/834641  
Telex: 81594 SAWCOM



The StarBASE professional database management system consists of a 16K ROM, 51K of extension and applications software on disc and a comprehensive manual. StarBASE was designed by a chartered electronics and software engineer to meet a defined need for a high specification, disc-based random access system. The database program and extension software is "Menu Driven", particularly user-friendly, quick to use, but extremely powerful and totally flexible. It is absolutely ideal for use in schools, clubs, colleges, small businesses and in the home.

- Menu Driven throughout
- True random access - will locate a single record in under 2 seconds typically.
- File size is the capacity of a single disc (double sided if applicable) - minus 5K.
- Maximum number of fields 69.
- Maximum number of characters in a field 255 (subject to an overall maximum of 920 in a record).
- Up to 4096 records.
- Records are displayed and input on a "Card Screen" principle. Layout of fields and headings are built entirely by the user by "Painting" on the screen (colour can be used).
- Direct and rapid entry of data into all or selected fields.
- Search criteria include =, <, >, <., and a wildcard "anywhere in the field".
- Unlimited and rapid sequential searching and selecting.
- All or selected records can be sorted to a depth of 5 fields, each in ascending or descending order, using the super-fast Shell-Metzner routine.
- Instant print or display review of file, giving breakdown of record size, number of records possible and space used, etc.
- Address and label printing (up to 8 across the page).
- Selected whole or part field-content printing, with left and right justification, tabbing, and embedded printer control codes possible. Can be mixed with text for invoices and form letters etc.
- Can be configured for any printer (including £ character definition).
- Continuous or paged printout with page heading and pause at each page end, with "New Page" prompt.
- Repeat printing for multiple copies.
- Percentage and arithmetic operations to specified decimal placing.
- Field statistics giving totals, mean and standard deviation, variants and squares.
- Optional password lock.
- Fully documented routines (in Basic) which can be spooled onto user-written tailor-made file management and interrogation programs.

StarBASE meets and even exceeds professional standards found on large installations. It is unique in speed, flexibility and ease of use.

Price? Only £69.00 inc VAT (plus £1.50 p & p).

● Circle No. 168

# OKIDATA



## Printer High speed Microline 84

Just say „one-hun-dred!“ Mean-while the Microline 84 printer is at its 200th character. 200 per second - that makes 12.000 in a minute, 720.000 in an hour, with a printhead life of 200 Million characters.

The Microline 84 achieves quantity - but not at the expense of quality. In addition to matrix printing it also undertakes your correspondence (50 characters/sec.) using its dual pass mode.

A pre-arranged variety of character sets are permanently stored in its EPROM's for instance; special characters for IBM-PC's and additional memory for your specific character sets. With a carriage width of 136



characters you can print A4 format either portrait or landscape. Optionally the Microline 84 can be supplied with a cut sheet feeder.

Microline printers are fully compatible. Their interfaces permit parallel and serial data input from current desk top computers and P.C.'s with or without buffer storage.

We will be glad to send you detailed information. Please send us the coupon or simply phone. OKIDATA. Part of the OKI Electric Industry Company Ltd., founded in 1881.

### COUPON

Please send me/us more information about:  
 MICROLINE 84  
 The whole MICROLINE-Programme

Name \_\_\_\_\_

Street \_\_\_\_\_

City \_\_\_\_\_

Phone \_\_\_\_\_

Manufactured by OkI Electric Industry Co.,Ltd.,Tokyo

## OKIDATA

 GmbH

Emanuel-Leutze-Strasse 8  
D-4000 Düsseldorf 1 · West Germany  
Tel. 0211 592031 · Telex. 8 587 218  
Telefax: (0211) 593345

# '1984' THE YEAR OF 2000

## SAPPHIRE 2000 SERIES REMOTE CONTROL PRINTERS

**IMAGINE THE PRINTER OF THE FUTURE...** the printer which offers everything. At power-on, miriads of LED'S twinkle their vital information to you. Banks of microswitches on the extended front panel allow selection of the precise option of your choice, and with the aid of touch sensor control switches, you're ready to go. About as easy to operate as Concorde—all simply described in the 3 volume instruction manual.

**NOW IMAGINE THE PRINTER BEYOND THE FUTURE...** the printer which offers millions of configurations. The printer which needs no tuition or manuals, no exasperating phone calls.

The printer which has no switches or LED'S, no control panel.

**THE SAPPHIRE 2000...** combines sophistication with ingenuity. The result: fast, clear. Perfect simplicity.

The Remote Control Unit provides the window through which the operator can select, from the thousands of millions of options, the precise configuration required. Simply, quickly and permanently. Sapphire doesn't forget when you switch it off—it retains the precise options you select for next time.



It even retains more than one set of options—so you can have it set up ready for different jobs. A mere seven buttons allow this, full paper handling options and the usual master controls all from where you sit.

For further details of this revolutionary printer, fill in the coupon below to-day and we will make 1984 the Year of 2000 for you.

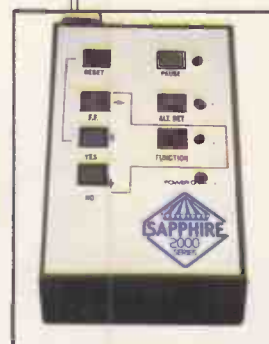

Please send me further details of the SAPPHIRE 2000 SERIES by return.

NAME: \_\_\_\_\_

ADDRESS: \_\_\_\_\_

POST CODE: \_\_\_\_\_

TELEPHONE: \_\_\_\_\_

MICROPUTE, Catherine Street, Macclesfield,  
Cheshire. SK11 6QY.

TELEPHONE: 0625-615384.



THE YEAR OF THE SAPPHIRE 2000.



# SAPPHIRE 2000 SERIES

RESET      PAUSE

FF.      ALT. SET

YES      FUNCTION

NO      POWER ON

**SAPPHIRE  
2000  
SERIES**

# Professionals Choice...

**Which is why IBM  
chose Cord Designs as  
one of their dealers**



Looking for practical advice and guidance in your search for a Business Computer? At Cord Designs we have been solving business problems for several years. We are now offering the IBM PC as part of our extensive product range, which makes our service hard to beat.

The IBM PC will be supported to the same high standard our clients have come to expect, clients like National Westminster Bank, British Aerospace, Saudia Airlines, Shell U.K. and many more. You will want to be sure the aftersales support match your new computer. Well back-up and maintenance are a by word at Cord. Of course we support a full range of software such as Lotus 1-2-3, Open Access, full accounts and specialist packages.



To find out more about the professionals choice phone or fill in the coupon for further details.

## Cord Designs Ltd

Victor House, Norris Road,  
Staines, Middx TW18 4DS  
Tel: (0784) 56601.

Please send me further details of the IBM PC

NAME \_\_\_\_\_

ADDRESS \_\_\_\_\_  
\_\_\_\_\_  
\_\_\_\_\_  
\_\_\_\_\_



● Circle No. 170



# >OPEN FILE

PRACTICAL COMPUTING

JULY 1984

## Open File monitors

Apple ..... John Harris  
Atari ..... Jack Schofield  
BBC ..... Nicholas McCutcheon  
Commodore ..... Mike Todd  
Dragon ..... Ian Stobie  
Epson HX-20 ..... John Wellsman  
IBM PC ..... Jack Schofield  
Newbrain ..... David Watt  
Tandy ..... John Wellsman  
Research Machines ..... Ian Stobie  
Sharp ..... John Hooper  
Sinclair ..... John Wellsman

Open File is the part of the magazine written by the readers of *Practical Computing*. All aspects of microcomputing are covered, from games to serious business software and utilities. Fully-debugged programs can be submitted for any micro, and for standard CP/M machines such as the Osborne and Superbrain. Programs can be in machine code or any language, including Forth and Pascal.

Submissions should include a brief description which explains what your program does, and how it does it. If possible it should be typed, with lines double-spaced. We need a printed program listing. Hand-written listings cannot be accepted. A tape or disc of the program helps if it is in a standard format.

When printing listings, please remember to use a new ribbon or double-intensity printing — faint listings reproduce badly. Use plain paper only, and try to list the program across either a 35-character or a 70-character width. Also, make sure all special graphics or inverse-video characters are either listed correctly or else include Rem statements to explain them fully.

Each program listing, tape or disc must have your name and address on it, or we cannot promise its safe return. A stamped addressed envelope is appreciated.

If you write in with a comment, correction or enquiry please remember to state the machine and the program title.

We pay at least £10 for any programs used, or £35 per page and pro rata for part pages.

## >BBC

### 146 CHARACTER HANDLER

Yet another character handler. This one is claimed to be easy to use and offers eight different functions to the user.

### 151 MISSILE COMMAND

This program from Leon Goodfriend plays a version of the arcade game in which the player must defend cities from oncoming nuclear attack.

## >RESEARCH MACHINES

### 155 L-GAME STRATEGY

Based on Edward de Bono's board game, the L-game for the 380Z pits a human player against the computer in a taxing battle of wits.

### 157 DATASTAT

Copy data from disc files into Basic Data statements with this utility program for the 380Z written by Andrew Matthews.

### 157 SIR!

Perhaps the shortest program ever contributed to Open File: schoolteachers across the land will come to detest this tiny teaser submitted by D Lane.

## >ATARI

### 159 JOYSTICK READER

A joystick-reading utility is included in Alan Wood's short graphics-demo program.

### 159 AUTO-LOADER

Alan Wood strikes again. This time he offers an auto-load routine, which provides rules or a title page on screen while your main program loads.

### 159 BLACK & WHITE

Matthew Dunn's fashionably titled program allows you to get rid of the Atari's blue screen background and replace it with a more pleasing black and white screen.

### 159 CALENDAR IMPROVER

A modification of Philip Wade's program, which was published in November. With it you can write three screens at once into different parts of memory.

### 159 TURNING TABLES ON ATARIWRITER

Jack Schofield offers a hint on handling tables that could change your life.

## >COMMODORE

### 161 PET ANIMATION

Achieving simple animation on the Pet is not difficult, but can prove cumbersome. Two programs provided by G H Ryder now offer a painless method of doing it.

## >APPLE

### 163 DEDUCITY

See what a jet-setter you are in this novel game from J Taylor which allows the Apple to beat all comers at guessing, then spelling, the names of capital cities.

### 165 DRACULA

You can play around with vampires in this version of Dracula from Nilesh Patel.

## >SINCLAIR

### 167 SPECTRUM SPREADSHEET

Put life in your computer with A M Tucker's program which takes advantage of the Spectrum's special facilities.

Send your contribution to:

Open File, Practical Computing,  
Quadrant House, The Quadrant,  
Sutton, Surrey SM2 5AS

# Character handler

```

10 MODE4
20 BK=4:FG=7
30 VDU19,0,BK;0;19,1,FG;0;
40 *FX 4,1
50 !&FE00=&10200A
60 PROCINIT
70 PROCSCREEN
80 PROCCHOICE
90 PROCMOVE
100 GOT080
110 *****
120 DEF PROCINIT
130 X=368:Y=832
140 CT=0:Z=224:Q=4:F=5:OF=5
150 DIM A(8),CR(8),S(4),FS(5)
160 FORI=0T04:READFS(I):NEXT
170 FORI=1T08:READA(I):NEXT
180 ENDPROC
190 DATAREVERSE,COPY,CLEAR,COLOUR,QU
IT
200 DATA 128,64,32,16,8,4,2,1
210 *****
220 DEF PROCSCREEN
230 MOVE448,928:DRAW768,928
240 MOVE448,992:DRAW768,992
250 FORI=448T0768 STEP64
260 MOVEI,928:DRAWI,992
270 NEXT
280 VDUS:MOVE144,976:PRINT"FUNCTION
0 1 2 3 4":VDU4
290 !&FE00=&10200A
300 FORI=352T0864 STEP64
310 MOVE 352,I
320 DRAW 864,I
330 NEXT
340 FORI=352T0864 STEP64
350 MOVE I,352
360 DRAW I,864
370 NEXT
380 FORI=224T0255:PRINTTAB(I-220,27)
;CHRS(I):NEXT
390 PRINTTAB(3,27);"C";TAB(36,27);"
"
400 ENDPROC
410 *****
420 DEF PROCMOVE
430 *FX 15
440 GCOL3,1
450 PROCPRINTOUT
460 PROCLINE
470 PX=(X-432)/64+2:PY=(896-Y)/64
480 A=INKEY(5)
490 *FX 15
500 IF F<>OF THENOF=F:F=5:PROCFUNCTI
ON
510 OX=X:OY=Y
520 IF A=137 THENPROCLINE:X=X+64
530 IF A=136 THENPROCLINE:X=X-64
540 IF A=139 THENPROCLINE:Y=Y+64
550 IF A=138 THENPROCLINE:Y=Y-64
560 IF A=32 AND ?(FNS)=0 THEN CR(PY)
=CR(PY)+A(PX):GCOL0,1:PROCFILL(X,Y,1)
570 IF A=69 AND ?(FNS)=255 THEN CR(P
Y)=CR(PY)-A(PX):GCOL0,0:PROCFILL(X,Y,1)
580 IF INKEY(-21) THENPROCLINE:F=4:P
ROCFUNCTION:ENDPROC
590 IF INKEY(-33) THENPROCREVERSE:GO
T0650
600 IF INKEY(-115) THENF=2:PROCFUNCT
ION:PROCLINE:PROCCLEAR:FORI=1T08:CR(I)
=D:NEXT:GCOL3,1:PROCLINE:PROCPRINTOUT:
GOTO650
610 IF INKEY(-116) THENPROCCOL:VDU19
,0,BK;0;19,1,FG;0;
620 IF INKEY(-114) THENPROCCOPY
630 IF X<352 OR X>864 OR Y<352 OR Y>
864 THENX=OX:Y=OY:PROCLINE
640 IF X<>OX OR Y<>OY THENPROCLINE
650 GOTO470
660 *****
670 DEF PROCLINE
680 MOVE X,Y
690 DRAW X+32,Y
700 ENDPROC
710 *****
720 DEF PROCFUNCTION
730 PRINTTAB(25,1);" ";
740 PRINTTAB(25,2);" ";
750 GCOL0,0:PROCFILL(464+(OF*64),960
,2)
760 GCOL0,1
770 IF F<>5 THENPROCFILL(464+(F*64),
960,2)
780 VDU5:MOVE464,976:PRINT"0 1 2 3 4
"FS(F):VDU4;!&FE00=&10200A
790 GCOL3,1
800 ENDPROC
810 *****
820 DEF PROCCOPY
830 F=1:PROCFUNCTION
840 PRINTTAB(0,24);"CHR-NO. ":"INPU
TAS:Z=VAL(AS)
850 IF Z<224 OR Z>255 THEN840
860 PRINTTAB(0,24);" ";
870 PROCPRINTOUT
880 FORI=224T0255:PRINTTAB(I-220,27)
;CHRS(I):NEXT
890 ENDPROC
900 *****
910 DEF PROCFILL(C,D,E)
920 IF E=1 THENPROCLINE
930 MOVE C-12,D-28:MOVEC-12,D+28
940 PLOT 85,C+44,D-28
950 PLOT 85,C+44,D+28
960 IF E=2 THENENDPROC
970 GCOL 3,1
980 PROCLINE
990 PROCPRINTOUT
1000 ENDPROC
1010 *****
1020 DEF PROCPRINTOUT
1030 PRINTTAB(18,23);" ";
1040 PRINTTAB(18,24);" ";
1050 VDU23,Z,CR(1),CR(2),CR(3),CR(4),
CR(5),CR(6),CR(7),CR(8)
1060 PRINTTAB(20,24);CHRSZ;TAB(Q,27);
CHRSZ;
1070 FORI=1T08
1080 PRINTTAB(29,4+I*2);CR(I);" ";
1090 NEXT
1100 PRINTTAB(13,22);"CHARACTER ";Z;
1110 ENDPROC
1120 *****
1130 DEF PROCSELECT1
1140 PRINTTAB(Q,28);" _";
1150 *FX15
1160 A=GET
1170 *FX15
1180 IF A=136 AND Q>4 THENPRINTTAB(Q,
28);" ";Q=Q-1
1190 IF A=137 AND Q<35 THENPRINTTAB(Q
,28);" ";Q=Q+1
1200 IF A=32 THENPRINTTAB(Q,28);" ";:
GOTO1220
1210 GOTO1140
1220 FORI=0T07
1230 CR(I+1)=?(HIMEM+(Q+(27*40))*8+I)
1240 NEXT
1250 ENDPROC
1260 *****
1270 DEF PROCSELECT2
1280 FORI=1T08
1290 D=CR(I):CT=816
1300 REPEAT
1310 IF D/2=INT(D/2) THENGCOL0,0 ELSE
GCOL0,1
1320 PROCFILL(CT,896-I*64,2)
1330 D=INT(D/2)
1340 CT=CT-64
1350 UNTIL D<1
1360 IF CT<368 THEN1390
1370 GCOL0,0
1380 REPEAT:PROCFILL(CT,896-I*64,2):C
T=CT-64:UNTIL CT<368
1390 NEXT
1400 Z=Q+220
1410 ENDPROC
1420 *****
1430 DEF FNS=HIMEM+(PX*2)+10+((PY*2)
+4)*40)*8+6
1440 *****

```

CHARACTER GENERATORS and handlers have always been a thing of the present generation of computers and their users. We have already published quite a few — but here is another, with just about the same ideas as the rest except I have chosen to call it a character handler, not a generator, for reasons that should become clear.

It is essentially a generator with a few minor adjustments. One of them is the eight different functions available to the user. Four are function keys and four are numeric responses.

To edit a character place the cursor underneath it and hit the space bar. The chosen character is then displayed in the large grid and functions can be performed on it. This particular program does not allow the movement of X characters to be displayed, but for all that it is quite easy to use.

```

1450 DEF PROCCHOICE
1460 *FX 15
1470 FORI=224T0255:PRINTTAB(I-220,27)
;CHRS(I):NEXT
1480 PRINTTAB(0,5);"M O D E"
1490 PRINTTAB(0,6);"-----"
1500 PRINTTAB(0,8);"1.EDIT"
1510 PRINTTAB(0,10);"2.VIEW"
1520 PRINTTAB(0,12);"3.LOAD"
1530 PRINTTAB(0,14);"4.SAVE"
1540 PRINT" ";:CHRS(8);
1550 VDUS:VDU4
1560 AS=GET$
1570 !&FE00=&10200A
1580 A=VAL(AS)
1590 IF A<1 OR A>4 THEN1510
1600 PRINTAS
1610 IF A=1 THENPROCSELECT1:PROCCLEA
T2:ENDPROC
1620 IF A=2 THENPROCSMALL
1630 IF A=3 THENPROCCLEAR:RUN
1640 IF A=4 THENPROCCSAVE:RUN
1650 GOTO1520
1660 ENDPROC
1670 *****
1680 DEF PROCSMALL
1690 PROCCLEAR
1700 GCOL0,1
1710 FORI=384T0864 STEP64
1720 MOVE 352,I
1730 DRAW 864,I
1740 NEXT
1750 FORI=384T0864 STEP64
1760 MOVE I,352
1770 DRAW I,864
1780 NEXT
1790 FORI=1T08:PRINTTAB(29,4+I*2);"
";:NEXT
1800 PRINTTAB(13,22);" ";
1810 PRINTTAB(20,24);" ";
1820 FORK=1T04
1830 PROCSELECT1
1840 FORII=1T08
1850 IF K=2 OR K=4 THENCT=816:CS=592
ELSE CT=560:CS=368
1860 IF K=1 OR K=2 THENCY=896 ELSE CY
=640
1870 D=CR(II)
1880 REPEAT
1890 IF D/2=INT(D/2) THENGCOL0,0 ELSE
GCOL0,1
1900 PROCFILL(CT,CY)
1910 D=INT(D/2)
1920 CT=CT-32
1930 UNTIL D<1

```

(continued on page 151)

GO 4th WITH NATIONWIDE

# apricot

Incorporating  
Sirius Nationwide  
5Mb 10 Mb  
now available

## The FIRST, Fourth Generation Personal Computer

Foremost distributors of the U.K.'s best-selling ACT Sirius the Nationwide Dealer Group now offer the very latest personal computer product from the ACT stable—Apricot. Designed and manufactured in Britain, Apricot is the first, fourth generation personal computer—a computer that for the first time works with you rather than just for you, hardware and software co-ordinating perfectly.

Apricot's many unique features include: a second screen located on the keyboard, which can be used without the main monitor to provide a truly portable briefcase-size system; a built-in calendar; calculator and time display; revolutionary 3½" diskettes which are convenient and compact, yet offer increased storage capacity; plus full 16-bit processing, multi-processor architecture and a powerful 256K RAM as standard.

From  
Just  
£1890\*



### Apricot and Nationwide

Nationwide are one of few specialist suppliers that can offer an Apricot system tailored to your exact needs and provide service and support facilities literally anywhere in the U.K.

Nationwide's library of available software covers everything from Word Processing, Database management, Accounting and Finance (including graphics output) to software for specific businesses and professions. And expert Nationwide staff will make sure you choose the software that is just right for you.

If you'd like to talk to Nationwide about an Apricot computer system, clip the coupon or telephone the nearest Nationwide Dealer listed here...there's probably one right on your doorstep.

**Bristol**  
Business World Ltd.  
0272 277104

**Cambridge**  
Anglia Business Computers Ltd.  
0223 315580

**London Central**  
Spiro Microcomputers Ltd.  
01-499 1608

**London N, SW, W, SW**  
Thames Micros Ltd.  
01-561 3636

**Solihull**  
Taylor Wilson Systems Ltd  
056 45 6192

**Surrey**  
Carville Computer Services Ltd.  
0306 881681

**Hull**  
Micro Supplies Ltd  
0482 28811

**Northern Ireland**  
Northern Ireland  
Computer Centre Ltd  
02317 6548

**Reading**  
PPM Micros Ltd.  
0734 508787

**West Bromwich**  
Isis Ltd  
021-525 7605

**Middlesex**  
Wilson Hughes & Partners Ltd.  
0895 53332

**West Lothian**  
Holdene Ltd  
0506 827506

**Leeds**  
Holdene Ltd  
0532 459459

**Manchester**  
Holdene Ltd  
0625 529486

Full range of Sirius also available at the above locations.

To: Nationwide, Bray House, Leicester Place,  
Leeds LS2 9BH. Tel: (0532) 459459  
I would like to know more about Apricot microcomputer systems.  
Name: \_\_\_\_\_ Position: \_\_\_\_\_  
Company: \_\_\_\_\_  
No. 251

 **NATIONWIDE  
DEALER GROUP**



TORCH Computers were pioneers of the communicating personal computer. Today the TORCH is widely used by large and small businesses, local government authorities, the Armed Forces and central government departments.

Every TORCH C-SERIES has integrated Software to give colour VIEWDATA access, Datel 600, TORCHMAIL PLUS – the most sophisticated and powerful ELECTRONIC MAIL system available – and a variety of optional mainframe communication packages.

In addition every TORCH now has TORCHNET, a unique and advanced local area network incorporating ECONET\* technology.

TORCHNET is an integrated part of each TORCH – which shares resources among users, giving SHARED access to disc printers and communications facilities. TORCHNET provides TELECONFERENCING, file exchange, and broadcast and individual messages.

NOW, with the availability of the triple-processor TORCH 725, TORCHNET permits the use of UNIX\* III and CP/M\* software, independently or concurrently. Consider a networked PC that allows you to benefit from the vast library of CP/M software AND to develop for the future with full UNIX facilities on the 68000 TORCH processor; here is a major advance towards an OPEN SYSTEM, one



## OPEN SYSTEMS FROM TORCH

which will allow you to work freely without the constraints and costs of incompatible standards.

TORCH COMPUTERS are committed to breaking down the barriers others have created. TORCHNET will soon have bridges to other networks and to other operating systems. The computer professional will appreciate the value of THE TORCH.

# TORCH

COMPUTERS



### Lighting the way ahead.

Torch Computers Limited Sales Department  
Abberley House Great Shelford Cambridge CB32 5LO  
Telephone - (0223) 841000 Telex - 818841 TORCH G  
FREEPHONE-TORCH

I wish to find out more about the TORCH 725 ● Circle No. 234 PC2  
 Please arrange for a salesman to call. Please tick appropriate box.

NAME \_\_\_\_\_

TITLE \_\_\_\_\_

COMPANY \_\_\_\_\_

ADDRESS \_\_\_\_\_

149

TEL \_\_\_\_\_

# FORTH = TOTAL CONTROL

**FORTH** programs are instantly portable across the most popular microprocessors.

**FORTH** is interactive and 20 times faster than BASIC.

**FORTH** programs are structured, modular, and easy to maintain.

**FORTH** gives control of all interrupts, memory locations, and i/o ports.

**FORTH** application programs can be converted to turnkey programs.

**FORTH** Cross Compilers can generate ROMmable code for: 6502, 6809, 68000, 8080, Z80, 8086, 6800, 6801/3, 1802, Z8, 8070, Z8000, 99xxx, LSI-11

We are the FORTH specialists, we also stock a large range of books, listings, and implementations for machines ranging from Spectrums to VAXes.

**Application Development Systems** include FORTH with virtual memory, multi-tasking, assembler, utilities, and full documentation.

**Z80 or 8080 FORTH** - CPM 2.2. £60

**8086 FORTH** - CPM-86, MSDOSE95

**PC/FORTH** - PC/DOS, CPM-86. £95

**8086 FORTH-83** - CPM-86, MSDOS

.....£120

**PC/FORTH-83 PC/DOS, CCPM**.....£120

**68000 FORTH** - CPM-68K.....£190

**FORTH+** has 32-bit stacks and directly accesses the whole address space of the processor.

**PC/FORTH+** .....£190

**8086 FORTH+** .....£190

**68000 FORTH+** .....£290

**Extension Packages** include floating point, cross compilers, 8087 support, colour graphics, databases ....



**MicroProcessor Engineering Ltd**  
21 Hanley Road, Shirley  
Southampton SO1 5AP  
Tel: 0703 775482



● Circle No. 247

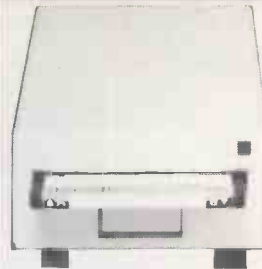

## datafax

### 3" Drive

Statacom Distribution Ltd. offer a complete range of 3" and 5¼" disc drives, interfaces and diskettes. We are the sole U.K. distributor for the hitachi 3" disk drives assembled by Datafax Systems Ltd.

The HITACHI 3" disc drive unit is now firmly established and is fast displacing the old 5¼" as the standard for home computers. The drives are more compact and slimline as well as lighter and more portable than the 5¼". They are faster (average track to track access time: 3ms) and use the latest L.S.I. technology, for a lower chip count and improved reliability. The floppy diskettes are enclosed in a rigid case which makes them dust proof, much more reliable and easy to handle. The diskettes are also fippable i.e. can be used on both sides! Don't settle for anything less than the legendary HITACHI reliability.

All drives supplied cased in a sleek metal casing, and complete with leads, cables and a utility disk. Each drive is tested and is covered by a full one year warranty. PRICES INCLUDE VAT.

One single sided 100k £192 One double sided 200k £252

Dual single sided 200k £369 Dual double sided 400k £499

NB: optional internal power supply unit available for £35 extra  
GENEROUS DEALER DISCOUNTS: for full price list please contact:- STATACOM DISTRIBUTION LTD.

234 HIGH ST. SUTTON 01-661-2266



● Circle No. 248

# WORDSWORTH

## Apricot and Epson Computers

Epson, Star and Daisywheel Printers,  
TEAC, TEC & NEC Disk Drives for  
most micros Verbatim and Dyan  
disks

Call us for prices

Low cost Microprocessor  
development systems for oil gas and  
water industries



**WORDSWORTH**  
6 GRANT ROAD  
BANCHORY  
AB3 3UR  
03302 4168

## Independent TRS-80 Software:-

From Anitek, Prosoft, MMS etc. for  
TRS-80 I, III & IV, Video Genie I, II,  
III, LNW & Lobo

LeScript/Newsprint/DOSPLUS 3&4  
DOS Random Access, Vols I & II and  
many others

Summer Sale, on selected items ends  
31st July

● Circle No. 236

(continued from page 146)

```

1940 NEXT
1950 S(K)=Q+220
1960 NEXT
1970 PRINTTAB(18,23);CHR$(1);CHR$(2)
)
1980 PRINTTAB(18,24);CHR$(3);CHR$(4)
)
1990 ENDPROC
2000 *****
2010 DEF PROC$FILL(A,B)
2020 MOVE A+22,B-26-(I*32):MOVEA+22,
B-2-(I*32)
2030 PLOT 85,A+46,B-26-(I*32)
2040 PLOT 85,A+46,B-2-(I*32)
2050 ENDPROC
2060 *****
2070 DEF PROC$CLEAR
2080 GCOL0,0
2090 FORA1=368T0816 STEP64
2100 FORA2=384T0832 STEP64
2110 PROC$FILL(A1,A2,2)
2120 NEXT
2130 NEXT
2140 ENDPROC
2150 *****
2160 DEF PROC$REVERSE
2170 F=0:PROCFUNCTION
2180 GCOL3,1:PROCLINE
2190 FORA1=368T0816 STEP64
2200 FORA2=384T0832 STEP64
2210 B1=(A1-16)/32:B2=(1024-A2)/32
2220 IF ?(HIMEM+(B1+(B2*40))*8+2)=128
THENGCOL0,1:CR((B2-4)/2)=CR((B2-4)/2)
+A((B1-9)/2) ELSE GCOL0,0:CR((B2-4)/2)
=CR((B2-4)/2)-A((B1-9)/2)
2230 PROC$FILL(A1,A2,2)
2240 NEXT
2250 NEXT
2260 PROC$PRINTOUT
2270 GCOL3,1:PROCLINE
2280 ENDPROC
2290 *****
2300 DEF PROC$LOAD
2310 CLS:PRINT"'"POSITION DATA-FILE
"
2320 X=OPENUP("CHARACTERS")
2330 PRINT"Loading."
2340 FORT=224T0255
2350 FORI=1T08
2360 INPUT#X,CR(I)
2370 NEXT
2380 VDU23,T,CR(1),CR(2),CR(3),CR(4),
CR(5),CR(6),CR(7),CR(8)
2390 NEXT
2400 CLOSE #X
2410 ENDPROC
2420 *****
2430 DEF PROC$SAVE
2440 CLS
2450 FORI=224T0255:PRINTTAB(I-223,15)
;CHR$(I):NEXT
2460 PRINTTAB(0,0)
2470 PRINT"'"POSITION CASSETTE'"
2480 X=OPENOUT("CHARACTERS")
2490 PRINT"Writing."
2500 FORT=224T0255
2510 FORI=1T08
2520 CR(I)=?(HIMEM+(T-223+(15*40))*8+
(I-1))
2530 PRINT#X,CR(I)
2540 NEXT
2550 NEXT
2560 CLOSE #X
2570 ENDPROC
2580 *****
2590 DEF PROC$COL
2600 F=3:PROCFUNCTION
2610 INPUTTAB(0,23)"Background "BK
2620 INPUT"Foreground "FG
2630 PRINTTAB(0,23) " "
2640 PRINT" "
2650 ENDPROC

```

```

10 MODE7:PROCINTRO
20 HSX=0:HI$="No-one":DIMX(12),YX(12)
),MX(12),EX(5),FX(5),SX(5),TX(5),CX(5),E
$(7):PROCSETUP
30 SX=0:LX=1:CX=5:EX=10000:SOUND1,0,0
,0:PROCSETCITY
40 COX=1
50 MX=12:IFLX>15MX=8
60 MODE2:VDU23;8202;0;0;0;
70 PRINT"Level High Score"
80 PRINT"Score Missiles"
90 PROCINIT
100 PROCICBM
110 PRINTTAB(0,1);LX;TAB(10,1);HSX";S
X;TAB(10);MX
120 VX=0
130 GCOL0,5
140 MOVEXX,YX:PLOT1,36,0:MOVEEX+20,YX-
16:PLOT1,0,35
150 PROCSTART
160 PROCMOVE
170 PROC$EXPLO
180 PROCMOVE
190 PROCLINES
200 PROC$CITY
210 IFFX=0THEN240
220 IFCXTHEN160
230 GOTO1630
240 IFCX=0THEN1630
250 FORDX=1T05:PROCCITY:PROCXEXPLO:PROC
EXPLO:PROC$PAUSE(.3):NEXT
260 *FX15
270 IFCOX=2THEN310
280 COX=2
290 PROC$PAUSE(1)
300 GOTO60
310 PROC$PAUSE(1)
320 GCOL0,0
330 VDU24,0;32;1279;896;16,26,19,1,4;0
;
340 COLOUR3
350 AX=8303
360 SOUND3,-12,156,8
370 GCOL0,3
380 PRINTTAB(7,9)"BONUS":MOVE440,696:
DRAW816,696
390 PROC$PAUSE(1)
400 SOUND3,-12,180,8
410 PRINTTAB(3,13)"CITIES:"
420 PRINT'TAB(2)CX" x 50 = "CX*50
430 PROC$PAUSE(1)
440 SOUND3,-12,204,8
450 PRINTTAB(1,18)"MISSILES:"
460 PRINT'TAB(2)MX" x 5 = "MX*5
470 MOVE800,320:PLOT1,248,0
480 MOVE800,300:PLOT1,248,0
490 PROC$PAUSE(1)
500 SOUND3,-12,228,8
510 PRINTTAB(6,24)"TOTAL: "50*CX+5*MX
520 AX=8A0A
530 COLOUR7
540 SX=SX+50*CX+5*MX

```

## Missile Command

This program from Leon Goodfriend of Cardiff, South Glamorgan plays a version of the arcade game Missile Command, in which the player must defend cities from a nuclear attack.

The missiles descend from the top of the screen towards your cities. As the missiles get lower, their angle of deviation increases and you have to move about the screen quickly in order to destroy them, which you do by exploding a bomb under them.

The bombs originate from any one of three bases situated at the left, centre and right of the screen. You have a limited number of anti-ballistic missiles. These are

fired by positioning your sight wherever you want one to explode, and hitting the Shift key. The base nearest your target will despatch a missile.

You are awarded an extra city for every 10,000 points scored up to 100,000 points and every 20,000 points thereafter. After 15 screens, the number of missiles available to you decreases. When you key in the program you type the instructions as they are, to produce correctly aligned print when run. Each of the five cities at the bottom of the screen is a different logical colour, but they are all defined to be the same physical colour. This allows one or more cities to explode on-screen without affecting the others.

```

550 PRINTTAB(0,3);SX
560 IFSX<EXORCX=5THEN720
570 COLOUR14:COLOUR143:VDU19,14,11;0;1
9,15,12;0;
580 CX=CX+1
590 REPEAT AX=RND(5)
600 UNTILCX(AX)<0
610 CX(AX)=-CX(AX)
620 GCOL0,6
630 PROC$PAUSE(.9)
640 SOUND3,-12,252,8
650 PRINTTAB(5,27)"BONUS CITY"
660 VDU5
670 MOVECX(AX),32
680 PRINTCS
690 VDU4
700 EX=EX+10000
710 IFEX>100000EX=EX+10000
720 PROC$PAUSE(5)
730 MOVE-1280,1024:MOVE2560,1024
740 GCOL0,0
750 PLOT85,640,-600
760 LX=LX+1
770 GOTO40
780 DEFPROC$MOVE
790 KX=KXORINKEY(-1)
800 OX=X:OY=Y
810 XX=X+64*(INKEY(-104)-INKEY(-105))
820 YY=Y+64*(INKEY(-98)-INKEY(-66))
830 IFXX<128ORXX>1152XX=0XX
840 IFYY<100ORYY>800YY=0YY
850 GCOL0,5
860 MOVEOXX,OYX:PLOT3,36,0:MOVEOXX+20,
OYX-16:PLOT3,0,35
870 MOVEEX,YX:PLOT1,36,0:MOVEEX+20,YX-
16:PLOT1,0,35
880 IFFK=0IX=0:ENDPROC
890 PROC$FIRE
900 KX=0
910 ENDPROC
920 DEFPROC$EXPLO
930 IFVX=0ENDPROC
940 FORAX=1TOVX
950 BX=SX(AX)+1
960 SX(AX)=BX
970 IFBXMOD2=0THEN1030
980 PRINTTAB(EX(AX),FX(AX))E$(SX(AX));
990 IFBX<7THEN1030
1000 IFVX=1ORVX=AXVX=VX-1:GOTO1030
1010 SX(AX)=SX(VX):EX(AX)=EX(VX):FX(AX)
=FX(VX)
1020 VX=VX-1
1030 NEXT
1040 ENDPROC
1050 DEFPROC$FIRE
1060 IFVX=50RMX=0ORIXENDPROC
1070 SOUND&12,1,120,12
1080 IX=TRUE
1090 VX=VX+1
1100 SX(VX)=0:EX(VX)=XDIV64-2:FX(VX)=3
2-YXDIV32
1110 MX=MX-1
1120 PRINTTAB(10,3);MX" "
1130 ENDPROC
1140 DEFPROC$LINES
1150 GCOL0,1
1160 FORAX=1TONX
1170 IFAXMOD5=0PROC$MOVE:GCOL0,1
1180 IFFX(AX)=-1000THEN1260
1190 MOVEVX(AX),YX(AX)
1200 IFPOINT(XX(AX),YX(AX))=7THEN1280
1210 YX(AX)=YX(AX)-32

```

(continued on next page)

(continued from previous page)

```

1220 XX(AX)=XX(AX)+M*(AX)
1230 IFPOINT(XX(AX),Y(AX))=7THEN1280
1240 IFY(AX)=0THEN1370
1250 DRAWXX(AX),Y(AX)
1260 NEXT
1270 ENDPROC
1280 VDU19;6;0;
1290 SOUND&10,-15,6,15:SOUND0,-12,7,255
1300 XX(AX)=-1000
1310 SX=SX+100
1320 PRINTTAB(0,3);SX
1330 VDU19;4;0;
1340 FX=FX-1
1350 NEXT
1360 ENDPROC
1370 FX=FX-1
1380 IFPOINT(XX(AX),0)>7ORPOINT(XX(AX)-
M*(AX),0)>7PROCIE ELSE SOUND&13,-15,40,1
5
1390 DRAWXX(AX),0
1400 GCOLOR,1
1410 XX(AX)=-1000
1420 NEXT
1430 ENDPROC
1440 DEFPROC CITY
1450 FORAX=1TO5
1460 IFTX(AX)=5THEN1500
1470 IFTX(AX)TX(AX)=TX(AX)+1:VDU19,AX+7
,RND(7);0;
1480 NEXT
1490 ENDPROC
1500 TX(AX)=0:VDU19,AX+7;0;0
1510 NEXT
1520 ENDPROC
1530 DEFPROC DIE
1540 DX=X(AX)DIV256+1
1550 IFCX(DX)<0ENDPROC
1560 IFTX(DX)ENDPROC
1570 TX(DX)=1
1580 SOUND&13,-12,0,20:SOUND&10,-15,7,3
0:SOUND&11,2,120,30:SOUND1,0,0,0:SOUND1,
-12,3,255
1590 VDU19,DX+7,3;0;
1600 CX(DX)=-CX(DX)
1610 CX=CX-1
1620 ENDPROC
1630 PROC PAUSE(2)
1640 FORAX=1TO8
1650 VDU19;6;0;
1660 PROC PAUSE(.1)
1670 VDU19;0;0;
1680 PROC PAUSE(.1)
1690 NEXT
1700 *FX15
1710 MODE2:VDU23;8202;0;0;0;
1720 FORAX=1TO15:VDU19,AX;0;0;0;NEXT
1730 GCOLOR,0
1740 MOVE200,200
1750 PLOT85,0,1023
1760 PLOT85,200,823
1770 PLOT85,1279,1023
1780 PLOT85,1079,823
1790 PLOT85,1279,0
1800 PLOT85,1079,200
1810 PLOT85,0,0
1820 PLOT85,200,200
1830 VDU19;7;0;
1840 VDU24,208;200;1071;823;29,232;340;
1850 GCOLOR,143;CLG
1860 COLOUR8:COLOUR128:VDU19,8;0;0;
1870 PRINTTAB(5,2)"GAME OVER"
1880 AS="Final score: "+STR$(SX)
1890 PRINT"TAB(10-LEN AS/2)AS"
1900 RESTORE3500
1910 GCOLOR,7
1920 FORAX=0TO19
1930 MOVEAX*40,0:PLOT0,40,0
1940 READBX:PLOT81,-40,40*BX
1950 PLOT81,40,0
1960 NEXT
1970 FORAX=1TO7:VDU19,AX,7;0;0;NEXT
1980 SOUND&100,-15,7,80:SOUND&101,3,0,6
5
1990 VDU29,640;512;
2000 FORAX=9TO14
2010 GCOLOR,AX
2020 BX=(AX-9)*60-20
2030 MOVE0,0
2040 MOVE560=COS RAD BX,560*SIN RAD BX
2050 PLOT85,560=COS RAD(BX+40),560*SIN
RAD(BX+40)

```

```

2060 NEXT
2070 PROC PAUSE(.8)
2080 VDU19,7;0;0
2090 FORAX=1TO6:VDU19,AX,AX;0;19,AX+8,A
X;0;0;NEXT
2100 FORAX=1TO4
2110 PROC PAUSE(.2)
2120 FORBX=1TO6:VDU19,BX+8;0;0;NEXT
2130 PROC PAUSE(.2)
2140 FORBX=1TO6:VDU19,BX+8,BX;0;0;NEXT
2150 NEXT
2160 PROC PAUSE(.5)
2170 CLG
2180 VDU28,4,24,15,7
2190 COLOUR3:COLOUR143
2200 IFSX>HSXTHEN2260
2210 PRINT" HIGH SCORE"
2220 PRINT"TAB(4);HSX"
2230 PRINT" achieved by:"
2240 PRINT"TAB(6-LEN HIS/2)HIS"
2250 GOTO2460
2260 FORAX=1TO16
2270 SOUND&11,-15,15*AX,3
2280 AS=MID$( " CONGRATULATIONS",AX,1)
2290 PRINTTAB(0,AX-1)AS;TAB(11,AX-1);AS
2300 PROC PAUSE(.1)
2310 NEXT
2320 VDU28,5,24,14,7
2330 PROC PAUSE(.5)
2340 COLOUR2:PRINTTAB(1,14)"NEW HIGH"TA
B(2)"SCORE!"
2350 FORAX=1TO12
2360 PRINT
2370 PROC PAUSE(.1)
2380 NEXT
2390 PRINTTAB(3,7)"Your"" initials""
please"
2400 VDU28,7,19,13,18
2410 INPUT"? "TAB(0,0)HIS
2420 HIS=LEFT$(HIS,6)
2430 HSX=SX
2440 PROC PAUSE(.6)
2450 VDU28,6,25,13,21
2460 PRINT"Another game Y/N ?";
2470 *FX15
2480 AX=GETAND95
2490 IFAX=89THEN30
2500 IFAX<>78THEN2480
2510 MODE7
2520 END
2530 DEFPROC INTRO
2540 SOUND0,-12,6,42
2550 PRINTTAB(0,8)CHR$(130)'CHR$(130)
2560 FORX=15TO1STEP-1
2570 AS=MID$( "MISSILE COMMAND",X,1)
2580 AS=CHR$(141)+AS+CHR$(10)+CHR$(8)+C
HR$(8)+CHR$(141)+AS
2590 FORY=1TO2*X+2
2600 PRINTTAB(Y,8)AS
2610 NEXT
2620 NEXT
2630 PRINT"TAB(10)"By Leon Goodfriend
""TAB(7)"Type 'I' for instructions""T
AB(9)"or space bar to play.";
2640 FORA=1TO2000:NEXT
2650 A=GET
2660 IFA=32ENDPROC
2670 IFA<>73THEN2650
2680 CLS
2690 FORA=1TO2
2700 VDU31;A,131,157,132,141,31,12,A
2710 PRINT"MISSILE COMMAND"TAB(39,A)CHR
$(156)
2720 NEXT
2730 PRINTTAB(12)CHR$(129)"Instructions
:"
2740 PRINT"Your job is to protect your
cities from a nuclear attack. You can s
ee the trail left by each ICBM (inter -
continental";
2750 PRINT"ballistic missile) as it fa
lls through the night sky, but the only
way to save your cities is to destroy
the missile";
2760 PRINT"itself. This is, of course,
at the front of the trail. You have a lim
ited supply of high acceleration ground
to air ABM's";
2770 PRINT"(anti - ballistic missiles).
These are fired by positioning your
sight where you want the missile to e
xplore then pressing the missile release
button. The";

```

```

2780 PRINT"ABM will home in on this po
sition even if you move the sight. When
it explodes, the ABM leaves a large fire
ball, and it is this which can destroy an
ICBM."
2790 PRINT"TAB(7)"Press any key to cont
inue";
2800 *FX15
2810 A=GET
2820 IFINKEY(-99)THEN2820
2830 PRINTTAB(0,6)SPC(255)SPC(255)SPC(2
45);
2840 PRINTTAB(0,6)"Your sight is moved
using the following keys:-"
2850 PRINTTAB(17,10)CHR$(131)"Up""TAB(
18)CHR$(131)"A""TAB(11)CHR$(131)"Left <
+ ? Right""TAB(18)CHR$(131)"Z""TAB(16
)CHR$(131)"Down"
2860 PRINT"Use either SHIFT key to re
lease an ABM.""TAB(8)"Press SPACE BAR t
o play";
2870 REPEATUNTILINKEY(-99)
2880 ENDPROC
2890 DEFPROC ICBM
2900 NX=5+LX/2
2910 IFNX>12NX=12
2920 FX=NX
2930 FORAX=1TONX
2940 XX(AX)=RND(1320)-20
2950 YX(AX)=960-(AX+RND(3))*32
2960 IFYX(AX)>900YX(AX)=YX(AX)-32
2970 MX(AX)=(RND(1280)-XX(AX))/YX(AX)*
2+.5
2980 NEXT
2990 ENDPROC
3000 DEFPROC INIT
3010 VDU19;4;0;
3020 VDU5
3030 FORAX=1TO5
3040 IFCX(AX)<0THEN3090
3050 GCOLOR,AX+7
3060 VDU19,AX+7,6;0;
3070 MOVECX(AX),31
3080 PRINTCX;
3090 SX(AX)=0:TX(AX)=0
3100 NEXT
3110 VDU4
3120 XX=640:YX=512
3130 ENDPROC
3140 DEFPROC START
3150 COLOUR15
3160 PRINTTAB(7,18)"READY!"
3170 PROC PAUSE(1,2)
3180 SOUND0,-12,3,255
3190 COLOUR7
3200 PRINTTAB(7,18)" "
3210 ENDPROC
3220 DEFPROC SETUP
3230 ENVELOPE1,1,7,-1,0,15,45,0,5,-1,0,
-127,100,50
3240 ENVELOPE2,129,9,-1,0,15,45,0,1,0,0
,-127,1,1
3250 ENVELOPE3,5,1,21,-9,40,10,15,1,0,0
,-1,1,1
3260 VDU23,252,64,64,64,98,251,255,255,
255
3270 VDU23,253,4,4,4,22,55,183,191,255
3280 VDU23,254;16,16,80,240,240,240,240
3290 VDU23,255,255,255,255,255,255,255,
255,255
3300 CS=CHR$(252)+CHR$(253)+CHR$(254)
3310 FORBX=1TO4
3320 READAX:IFAX=TRUE THEN3350
3330 ES(2+BX-1)=ES(2+BX-1)+CHR$(AX)
3340 GOTO3320
3350 NEXT
3360 DATA9,255,255,8,8,10,255,255,-1
3370 DATA255,11,255,255,10,255,-1
3380 DATA32,11,32,32,10,32,-1
3390 DATA9,32,32,8,8,10,32,32,-1
3400 ENDPROC
3410 DEFPROC PAUSE(T)
3420 T=TIME+100*T
3430 REPEATUNTILTIME>T
3440 ENDPROC
3450 DEFPROC SETCITY
3460 FORAX=1TO5
3470 CX(AX)=240*AX-160
3480 NEXT
3490 ENDPROC
3500 DATA4,8,5,4,4,3,5,3,3,1,4,5,2,8,5,
4,4,5,4,7

```



Now available  
on Commodore  
IEEE.

# NO WAITING

Mon-Fri   
9-am 5-30pm

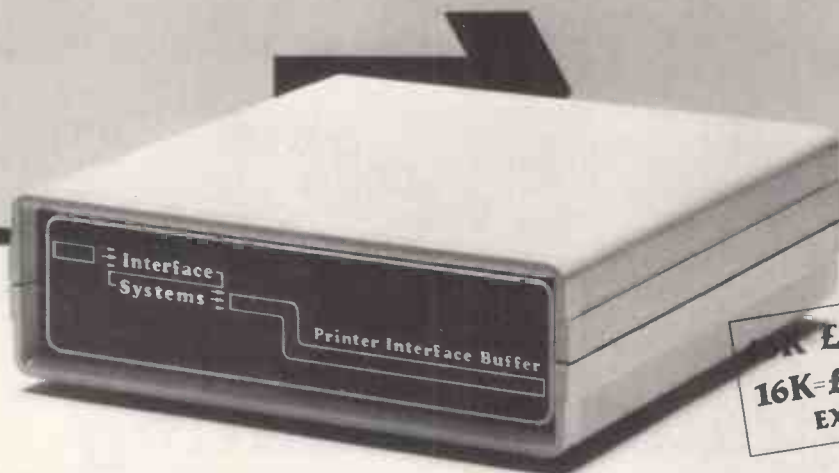

16K-£158.00  
EX.VAT

## Keep your micro motoring with a printer buffer

When you've invested some serious money in a micro system, why keep your system waiting while you print out your hard copy?

If you think about it, you must spend 1-2 hours every working day just waiting around – unless you invest in a printer buffer from Interface Systems.

Whatever micro you're using, our compact buffers simply plug into your system. So you can dump pages of text straight into the buffer, leaving your system free to carry on working for you – within seconds.

Every Interface System printer buffer comes with a full 90 day warranty. Yet they're still better value, bit for bit, than any other comparable buffer on the market.

We've made it simpler to get your hands on our buffer too – and our dealer network is still growing. Simply phone us direct for your nearest supplier, and start saving system time (and money) today.

**Interface**  
**Systems**

Interface House, 17 Eversley Road, Bexhill-on-Sea,  
Sussex TN40 1HA. Tel: 0424 225 683

Norman House, Heritage Gate, Derby DE1 1DD.  
Tel: 0332 364303.

Suitable for: Commodore · IBM · Digital Equipment Corp · Apple · Epson · Ricoh  
Diablo · Anadex · ACT Sirius · TeleVideo · Torch · Superbrain · N.E.C. · Sharp  
Corona · Morrow Designs · Osborne · Sage · Olivetti · Triumph Adler · Tandy *and many more.*

# Gemini

Business Software

**NEW!**



**£99.95  
per  
module**

## Integrated Accounting Programs for BBC 32K Micro

....Simultaneously and automatically integrates several accounting functions and provides accurate and up to date management information, including Balance Sheets.....all at the touch of a button.

Full, descriptive leaflet available from most good software shops, or direct from:

# Gemini

**Gemini Marketing Limited**

18a Littleham Road Exmouth Devon EX8 2QG England  
Telephone (0395) 265165/265832 Telex 42956 Attn Gemini

● Circle No. 243

# L-Game Strategy

THE L-GAME for the 380Z by A D MacDonald of Leigh-on-Sea, Essex, is based on Edward de Bono's board game of the same name. The program pits you against the computer in a game of strategy.

Play takes place on a four-by-four grid. Each player has one L shape, with two neutral pieces also on the board. The idea of the game is to position your L piece

together with the other two squares so that the computer cannot move its L piece to a new position.

The program starts by giving instructions and then asks you if you want to play first or second. When it is your turn the machine asks for the four blocks which define where your L piece is to move, and then allows you to move a neutral square if you want

to. The computer then makes its move and the cycle continues until either player is unable to move their L piece to a new position on the grid. The game involves thought, and you must look ahead if you want to win.

The program is written in fairly simple Basic and should not be hard to adapt for other brands of computer.

```

10 REM A. D. MACDONALD L-GAME A/D PROJECT
20 REM DIMENSION ARRAYS
30 DIM A(16), B(48), C(48), D(48), E(48), F(4; 16), S(4), T(4), U(4)
40 REM SET ARRAY VARIABLES
50 FOR Z=1 TO 48
60 READ B(Z), C(Z), D(Z), E(Z)
70 NEXT Z
80 FOR Z=1 TO 16
90 READ A(Z)
100 NEXT Z
110 FOR Z=1 TO 4
120 FOR Y=1 TO 16
130 READ F(Z, Y)
140 NEXT Y
150 NEXT Z

160 GOSUB 1650
170 ?CHR$(31):PRINT"DO YOU WANT TO GO 1ST OR 2ND (1/2)?:":
0$=GET$( )
180 IF 0$="1" THEN 210
190 IF 0$="" THEN 170

200 GOTO 1000
210 FOR Z=1 TO 750: NEXT Z
220 RANDOMIZE
230 REM FIND OUT WHERE HUMAN L IS
240 C=1
250 FOR Z=1 TO 16
260 IFA(Z) () THEN 280
270 T(C)=Z:C=C+1
280 NEXT Z
290 G=0

300 GOSUB 1480
310 REM ERASE OLD L PIECE
320 A(T(1))=0:A(T(2))=0:A(T(3))=0:A(T(4))=0
330 REM CHECK COMPUTER HASNT WON
340 FOR Z=1 TO 48
350 A=B(Z):B=C(Z):C=D(Z):D=E(Z)
360 IFA(A)=0 AND A(B)=0 AND A(C)=0 AND A(D)=0 THEN 390
370 NEXT Z
380 IF G=1 THEN 420 ELSE 1320
390 IFA=T(1) AND B=T(2) AND C=T(3) AND D=T(4) THEN 370
400 G=1:Z=48:GOTO 370
410 REM INPUT HUMAN AND CHECK ENTRY
420 ?:"?:"ENTER NEW POSITION..."
430 ?:"NEW POSITION IS ":

440 GOSUB 490
450 A1=A7:GOSUB 490
460 A2=A7:GOSUB 490
470 A3=A7:GOSUB 490
480 A4=A7:GOTO 540
490 A7=GET():A7=A7-48
500 IFA7) 9 THEN A7=A7-7
510 IFA7(1 OR A7) 16 THEN 490
520 IFA(A7) () THEN 490
530 ? " "A7;" "":RETURN
535 REM SORTING L VARIABLES
540 U(1)=A1:U(2)=A2:U(3)=A3:U(4)=A4
550 ST=0
560 FOR Z=1 TO 3
570 K1=U(Z):K2=U(Z+1)
580 IF U(Z+1)=U(Z) THEN 600
590 ST=1:U(Z)=K2:U(Z+1)=K1
600 NEXT Z
610 IF ST () THEN 550
620 A1=U(1):A2=U(2):A3=U(3):A4=U(4)
630 G=0

640 REM CHECK NOT SAME L
650 IFA1=T(1) AND A2=T(2) AND A3=T(3) AND A4=T(4) THEN ?:"?:"SAME L POSITION":GO TO 740
660 REM CHECK NEW L IS A REAL L
670 FOR Z=1 TO 48

```

```

680 A=B(Z):B=C(Z):C=D(Z):D=E(Z)
690 IFA1=ARANDA2=BANDA3=CANDA4=DTHEN 730
700 NEXT Z
710-IF G=1 THEN 750 ELSE 720
720 ?:"?:"NOT A PROPER L. SORRY!":GOTO 740
730 G=1:Z=48:GOTO 700
740 A(T(1))=1:A(T(2))=1:A(T(3))=1:A(T(4))=1:GOTO 210
750 REM ASSIGN NEW L VARIABLES
760 A(A1)=1:A(A2)=1:A(A3)=1:A(A4)=1
770 GOSUB 1480

780 REM SQUARE MOVEMENT
790 ?:"?:"DO YOU WANT TO MOVE A SQUARE (Y,N,B)?:
800 0$=GET$( ):IF 0$="S" THEN 1430
810 IF 0$="" THEN 820
820 IF 0$="N" THEN 1000
830 ?:"?:"FROM WHERE TO WHERE?:
840 A5=GET():A5=A5-48
850 IFA5) 9 THEN A5=A5-7
860 IFA5(1 OR A5) 16 THEN 840
870 IFA(A5) () THEN 840
880 ?:"?:"MOVED "A5" TO ":

890 REM ERASE OLD SQUARE
900 A(A5)=0
910 A6=GET():A6=A6-48
920 IFA6) 9 THEN A6=A6-7
930 IFA6(1 OR A6) 16 THEN 910
940 IFA(A6) () THEN 910
950 ?A6
960 FOR Z=1 TO 500: NEXT Z
970 REM ASSIGN NEW SQUARE
980 A(A6)=3

990 REM FIND OUT WHERE COMPUTER L IS
1000 C=1
1010 FOR Z=1 TO 16
1020 IFA(Z) () THEN 1040
1030 S(C)=Z:C=C+1
1040 NEXT Z
1050 G=0
1060 REM ERASE OLD COMPUTER L
1070 A(S(1))=0:A(S(2))=0:A(S(3))=0:A(S(4))=0

1080 REM COMPUTER MOVING L
1090 FOR Z=1 TO 48
1100 A=B(Z):B=C(Z):C=D(Z):D=E(Z)
1110 IFA=S(1) AND B=S(2) AND C=S(3) AND D=S(4) THEN 1130
1120 IFA(A)=0 AND A(B)=0 AND A(C)=0 AND A(D)=0 THEN 1150
1130 NEXT Z
1140 IF G=1 THEN 1170 ELSE 1400
1150 G=1:Z=48:GOTO 1130

1160 REM ASSIGN NEW L VARIABLES
1170 A(A)=2:A(B)=2:A(C)=2:A(D)=2
1180 REM ERASE OLD SQUARE
1190 R=INT(RND(1)*4)+1
1200 FOR Z=16 TO 1 STEP -1
1210 IFA(F(R, Z)) () THEN 1230
1220 A(F(R, Z))=0:Z=1
1230 NEXT Z

1240 REM MOVE TO NEW SQUARE
1250 R=INT(RND(1)*4)+1
1260 FOR Z=1 TO 16
1270 IFA(F(R, Z)) () THEN 1290
1280 A(F(R, Z))=3:Z=16
1290 NEXT Z
1300 GOTO 240

1310 REM COMPUTER WINNING
1320 FOR Z=1 TO 250: NEXT Z
1330 ?:"?:"I AM THE WINNER, UNLUCKY"
1340 REM ANOTHER GAME
1350 ?:"ANOTHER GAME (Y/N)?:
1360 INPUT 0$:IF 0$="" THEN 1360
1370 IF 0$="N" THEN END

```

(continued on page 157)



## Procom Technology Limited

Freepost  
St Neots, Cambs PE19 1BR

(no stamp required)

Telephone Number: 0480-219007

- i) All prices exclude VAT
- ii) Free delivery
- iii) Trade enquiries welcome
- iv) Ring for prices on orders of 10+ boxes

### Diskettes

Verbatim Datalife 5 1/4"	Price per box (10)
MD525/01 SSDD 48 TPI	£18.25
MD550/01 DS DD 48 TPI	£27.15
MD557/01 DS DD 96 TPI	£34.20
MD577/01 SSDD 96 TPI	£25.55

10 and 16 hard-sectored versions at same prices.

8"	
FD34-9000 SS SD	£26.00
FD34-8000 SS DD	£26.40
FD34-4001 DS DD	£30.50

32 hard-sectored versions at same prices.

Dysan 5 1/4"	Price per box (10)
104/1 SS SD 48 TPI	£21.30
104/1D SSDD 48 TPI	£23.43
104/2D DS DD 48 TPI	£33.43
204/1D SS DD 96 TPI	£33.43
204/2D DS DD 96 TPI	£41.73

10 and 16 hard-sectored versions at same prices.

8"	
3740/1 SS DD	£31.64
3740/1D SSDD	£32.69
3740/2D DS DD	£38.70

32 hard-sectored versions at same prices.

Verex by Verbatim MD200-01 5 1/4" SS SD (soft-sectored only)	£15.63
---	--------

### EPSON PRINTERS

RX-80	£245
RX-80 F/T	£262
FX-80	£349
FX-100	£475
MX-100	£410

### Xidex Precision Diskettes

5 1/4"	per 10
5012-1000 SS DD 48 TPI	£19.45
5022-1000 DS DD 48 TPI	£27.45
5012-2000 SS DD 96 TPI	£27.65
5022-2000 DS DD 96 TPI	£35.70

8"	per 10
8012-1000 SS DD	£26.40
8022-1000 DS DD	£31.90

● Circle No. 126

## Work on your own where you're not alone

A place where you can set up alone or start a business or open a branch office and not have to worry about who answers the phone when you're out.

And the location gives swift access to M4/M3 motorways, the North Circular, the Underground, British Rail and Heathrow Airport in a leafy environment with the Thames nearby.

It's London without the hassle.

**UNITS FROM 100 SQ. FT. AT £28 pw. INCLUSIVE**

Call in, phone or write: **Barley Mow Workspace, 10 Barley Mow Passage, Chiswick, London W4 4PH. Telephone 01-994 6477.**



● Circle No. 177

## FileStar



MicroSec's FileStar package will enable your CP/M or CP/M+ system to read, write, list directories and initialise 3740 compatible disks for:-

- UNIX ASCII Files
- IBM 3740 Basic Exchange Data-Sets
- DEC RT/II ASCII Files
- INTEL ISIS II ASCII Files
- MOTOROLA MDOS ASCII Files

All this for only **£110 + VAT!!**

Phone or write to MicroSec for further information or guidance on machine suitability.



# MicroSec

**49B Market Parade, Havant, Hants PO9 1PY  
0705 450055**

\*CP/M is the registered trade mark of Digital Research

● Circle No. 178

(continued from page 155)

```

1380 RUN
1390 REM HUMAN WINNING
1400 FORZ=1TO250:NEXTZ
1410 ?:"YOU HAVE WON,WELL PLAYED.."
1420 GOTO1350

1425 REM HUMAN CONCEEDING GAME
1430 ?:"ARE YOU SURE (Y/N) YOU CONCEDE THE GAME"
1440 O%=GET%():IF O%="Y" THEN END
1450 IF O%="" THEN 1430
1460 GOTO 770
1470 REM PRINTING BOARD WITH PIECES
1480 X=1
1490 ?CHR$(12)

1500 FORZ=1TO13
1510 ?TAB(13)
1520 IFZ=10RZ=40RZ=70RZ=100RZ=13THEN?"-----":GOTO1620
1530 FORY=1TO13
1540 IFY=10RY=40RY=70RY=100RY=13THEN?"-":GOTO1600
1550 IFA(X)=0THEN?" ";
1560 IFA(X)=1THEN?"X";
1570 IFA(X)=2THEN?"O";
1580 IFA(X)=3THEN?"*";
1590 IFY=30RY=60RY=90RY=12THENX=X+1
1600 NEXTY
1610 ?" ":IFZ=20RZ=50RZ=80RZ=11THENX=X-4
1620 NEXTZ
1630 RETURN

1640 REM INSTRUCTIONS
1650 ?CHR$(12):?TAB(15):"THE L-GAME":?TAB(15):"-----"
1660 ?:"?TAB(12):"BY A. D. MACDONALD"?
1670 ?:"THIS GAME IS PLAYED AGAINST THE":?"COMPUTER ON A FOUR BY FOUR GRID."
1680 ?:"THERE ARE 2 L'S(X=HUMAN O=COMPUTER)":?"AND 2 NEUTRAL PIECES (*). "
1690 ?:"THE BOARD IS DIVIDED UP AS BELOW:"
1700 ?TAB(14):"1 2 3 4":?TAB(14):"5 6 7 8":?TAB(14):"9 A B C":?TAB(14):"D E F G"
1710 ?:"THE AIM IS TO BLOCK THE COMPUTER SO":?"HE HAS NO NEW MOVE TO PLAY"
1720 ?:"IF YOU WANT TO STOP,PRESS 'G' WHEN ":?"ASKED TO MOVE A SQUARE."
1730 ?:"PRESS ANY KEY TO BEGIN...GOOD LUCK!"
1740 O%=GET%():RETURN
1750 REM DATA
1760 DATA 2,6,10,11,3,7,10,11,6,10,11,12,6,7,8,10,6,7,10,14,6,7,11,15,5,6,7,11
1770 DATA 7,9,10,11,2,3,6,10,2,3,7,11,6,7,8,12,8,10,11,12,6,10,14,15,7,11,14,15
1780 DATA 5,6,7,9,5,9,10,11,10,11,12,14,9,10,11,15,7,8,11,15,3,7,11,12,3,5,6,7
1790 DATA 2,6,7,8,5,6,10,14,2,6,9,10,9,10,11,13,10,11,12,16,1,5,6,7,4,6,7,8
1800 DATA 1,2,6,10,6,10,13,14,3,4,7,11,7,11,15,16,1,2,3,7,2,3,4,6,4,8,11,12
1810 DATA 7,8,12,16,10,14,15,16,11,13,14,15,5,6,9,13,1,5,9,10,1,2,5,9,5,9,13,14
1820 DATA 12,14,15,16,8,12,15,16,2,3,4,8,3,4,8,12,9,13,14,15,1,2,3,5
1830 DATA 0,1,1,3,0,1,2,0,0,1,2,0,3,2,2,0,5,3,12,14,9,2,8,15,6,11,7,10,1,13,4,16
1840 DATA 2,9,15,8,3,5,14,12,7,10,11,6,13,1,16,4,8,14,5,3,12,15,9,2,10,7,6,11,4
1850 DATA 16,13,1,15,8,2,9,14,12,3,5,11,6,10,7,16,4,1,13

```

## Datostat

A utility program for the 380Z has been written by Andrew Matthews from Old Harlow in Essex. Called Datostat, it copies data from disc files in Basic Data statements.

Datostat works by opening the specified disc file and creating a new Basic program. When the program is run you are asked to enter the name of the disc file the data is to be taken from, the name of the new program, and the length you want the Data statements to be. Datostat then reads through the disc file creating Data statements as it goes.

The variable A\$ is the name of disc file; B\$ is the name of program to be created; C is the length for Data statements, and D\$ is used for construction of Data statements.

## Sir!

This program by David Lane of Herne Bay, Kent is for the RML 480Z, which is found in many schools across the country. It must be the shortest contribution yet submitted to Open File as it contains only six bytes.

To enter the program, first press the Reset button. Then hold down the Ctrl key and press F to enter the front panel. Type

Datostat.

```

10 REM *** Andrew Matthews / DATASTAT
20 TEXT:PUT 31:CLEAR:CLEAR 500:L=1
30 INPUT"Name of Data File ";A$
40 INPUT"Name of New Program ";B$
50 INPUT"Length of Data Statement ";C
60 PUT 31:RESET
70 IF LOOKUP(B$)=0 THEN 120
80 PRINT"Program exists''Replace? ";
90 Y$=GET%():IF Y$="N" THEN TEXT:PUT 31:END
100 ?"YES"
110 ERASE B$:PRINT"Data Statement replaced"
120 IF LOOKUP(A$)<>0 THEN 140
130 PRINT"Data File does not exist":END
140 ON EOF GOTO 190:CREATE B$:OPEN #10,A$
150 D$=DATA ":FOR I=1 TO C
160 INPUT #10,G$:D$=D$+G$+"",":NEXT
170 D$=MID$(D$,1,LEN(D$)-1)
180 PRINT #10,L#10,D$:L=L+1:GOTO 150
190 D$=MID$(D$,1,LEN(D$)-1):PRINT #10,L#10,D$
200 CLOSE #10:PRINT"End of Data File Reached":END

```

M>7000

to move to address 7000 and enter the six bytes F7, 01, F7, 21, 18 and FA, pressing Return after each one. Press Reset again and load Basic in the usual way. Enter the

command

CALL &7000  
then rub it out using the cursor and Delt keys. Finally shout "Sir, the computer's broken!"

# THE BEST OF BOTH WORLDS

## COMPUTERS

Apricot 256K 630K DD + MON	£1450.00
Apricot 256K 10 + MON	£2279.00
Commodore 64	£ 152.18
Commodore VIC20 Starter Pack	£ 108.69
Commodore SX 64 (Portable)	£ 609.00
Kaypro 2	£1199.00
Kaypro 10MB	£2099.00
Oric Atmos 48K	£ 145.00
Sanyo MBC550 1 x 160K Disk drive	£ 699.00
Sanyo MBC555 2 x 160K Disk drive	£ 899.00
Sindair Spectrum 48K	£ 100.00
Sirius 1 128K 1.2MB	£1650.00
Sirius '1' 256K 2.4MB	£2150.00
Sirius '1' 256K 1.2 + 10.6MB	£2950.00

## PERIPHERALS

Sanyo 2112 Green Screen	£ 65.00
Sanyo 3117 Col Hi Res	£ 279.00
Commodore 1541 Disk Drive	£ 156.52
Commodore C2N Cassette	£ 35.00
Keyboards, cables, interfaces, tractor feeds, sheet feeds, disks, software, up grades, listing paper, ribbons, daisy wheels available for most products.	

- \* Superb stock of computers and peripherals
- \* Wholesale prices!
- \* Export facilities arranged
- \* Express delivery
- \* Guarantees available
- \* Dial-a-Quote: 01-947 8562

## DAISY WHEEL PRINTERS

Brother HR1	£ 329.00
Brother HR15	£ 145.00
Brother HR5	£ 246.00
Daisy Step 2000 (20CPS)	£ 675.00
Diablo 620	£1320.00
Diablo 630	£ 335.00
Juki 6100	£1190.00
Qume 11/40	£1590.00
Qume 9/45	£ 599.00
Qume Letter Pro 20	£ 899.00
Ricoh RP1300	£1239.00
Ricoh RP1600	£ 319.00
Uchida 18cps	

## DOT-MATRIX

Anadex DP 9000	£ 799.00
Canon PW 1080A (NLQ)	£ 275.00
Commodore MTS 801	£ 175.00
Commodore 1526 Printer	£ 250.00
Epson RX80T	£ 195.00
Epson RX80 F/T	£ 225.00
Epson FX80	£ 345.00
Epson RX 100 F/T III	£ 425.00
Epson FX100 F/T	£ 200.00
Mannesmann Tally MT80	£ 399.00
Mannesmann Tally MT160	£ 199.00
OKI Microline 80A	£ 635.00
OKI Microline 84	£1449.00
OKI Microline 2350	£ 449.00
Radix 10 (NLQ)	£ 179.00
Seikosha GP100A	£ 185.00
Shinwa CP80 F/T	£ 209.00
Star Gemini 10X	£ 309.00
Star Gemini 15X	£ 425.00
Star Delta 15	

All prices excluding V.A.T.



Spa House, 11-17 Worples Road, Wimbledon, London SW19 4JS Tel: 01-947 8562 Telex: WOWICO 8955888

● Circle No. 173

# VER-WORD

## THE WORD PROCESSOR

For Microcomputers running CP/M™

You will not believe the power of Word processing software that VER-WORD can bring to your machine.

- easy to learn and use
- what you see is what you get
- ideal separate command and edit modes
- powerful block text commands
- sophisticated column manipulation
- mail merging included

Write now for full specification brochure.

Orders are being accepted for the following hardware:

- Osborne
- Televideo
- Wordset
- CompuCorp (CP/M)



VERWOOD SYSTEMS  
Verwood House  
High Street,  
West Haddon,  
Northants NN6 7AP.

CP/M™ is a registered trade mark of Digital Research, Inc.

● Circle No. 174

# HI-TECH DESKS AT DOWN TO EARTH PRICES.

The Apollo business desk range from Opus

- Prices from £100 (inc. VAT and delivery).
  - 10 models available to suit leading computer systems.
  - Sturdy steel underframes.
  - Scratch resistant surfaces.
  - Drawer for disc storage.
  - Lower shelf for disc drives.
  - Attractive brown and cream finish.
  - Lockable castors.
  - Immediate delivery.
  - Made in Britain.
- Government and education discounts given.  
Dealer enquiries invited.



Model 10.

**Opus.**  
Opus Supplies Ltd.

158 Camberwell Road, London SE5 0EE, Telephone: 01-701 8668.

● Circle No. 175

# Joystick reader

A PROGRAM by Alan Wood of Walton on Thames demonstrates animated player-missile graphics using strings, which Atari Basic handles very quickly. A joystick-reading utility is incorporated within the program in line 120, and could be used elsewhere. Peeking location 632 is the equivalent of reading Stick(0). For anyone interested, the other joystick ports follow, then locations 644 to 647 give Strig(0) to Strig(3) — is the joystick button pressed?

A\$ is used to hold Player 0, B\$ the table of player shapes, XD and YD the joystick readings, and VVTP the variable value table. Line 70 sets up the player-missile graphics, line 120 reads the joystick, and line 130 inserts the correct player shape into the correct place in Player 0. Location 53248 is the horizontal position register of Player 0. Lines 140 and 150 move the player co-ordinates and check for screen edges.

## Auto-loader

A short auto-load routine comes from Alan Wood of Walton on Thames. You could expand it to provide rules or a title page on screen while you main program loads.

To use it, CSave the utility on to tape and remove it without rewinding. Load the main program, replace the tape and Csave the main program straight after the utility. Cload the utility and, leaving Play pressed, type Run. The title appears, then the main program is loaded and run automatically.

## Black & white

Matthew Dunn of Manchester dislikes having to program with the Atari's blue screen background — obviously he hasn't tried a Commodore 64! — and one way to

### Black & white.

```
0 REM BLACK & WHITE - MATTHEW DUNN
10 FOR I=0 TO 7:READ A:POKE 1536+I,A:NEXT I
20 POKE 2,0:POKE 3,6:POKE 9,2
30 DATA 169,0,141,198,2,108,250,191
```

### Joystick reader.

```
0 REM ** PLAYER MISSILE GRAPHICS DEMO
1 REM ** USING STRINGS TO STORE DATA
2 REM ** BY ALAN WOOD
10 DIM A$(256),B$(44),XD(15),YD(15)
20 FOR I=1 TO 44:READ A:B$(I,I)=CHR$(A):NEXT I
30 DATA 0,248,16,57,127,252,120,56,168,252,0,0,62,16,57,127,252,120,56,168,252,0
40 DATA 0,124,8,156,254,63,30,28,21,63,0,0,63,8,156,254,63,30,28,21,63,0
50 FOR I=1 TO 15:READ A:XD(I)=A:READ A:YD(I)=A:NEXT I:A=1
60 DATA 0,0,0,0,0,0,0,0,1,1,1,-1,1,0,0,0,-1,1,-1,-1,-1,0,0,0,1,0,-1,0,0
70 POKE 54279,PEEK(106)-16:POKE 559,62:POKE 53277,3:X=95:Y=200
80 POKE 704,88:POKE 710,224
90 VVTP=PEEK(134)+PEEK(135)*256
100 PLAYER=(PEEK(106)-16)*256+1024-PEEK(140)-PEEK(141)*256
110 POKE VVTP+3,INT(PLAYER/256):POKE VVTP+2,PLAYER-256*INT(PLAYER/256)
120 J=PEEK(632):IF XD(J)>0 THEN B=(XD(J)=1)*222
130 A$(Y,Y+10)=B*(A+B,A+B+10):POKE 53248,X
140 Y=Y+YD(J)+(Y<33)-(Y>213)
150 X=X+XD(J)+(X<49)-(X>200)
160 A=(A=1)*11+1:GOTO 120
```

### Auto-loader.

```
10 REM *** AUTOLOAD PROGRAMME ***
20 REM *** BY ALAN WOOD ***
30 REM ** INSERT TITLE ETC AS BELOW **
40 DIM A$(25)
50 GRAPHICS 18:POSITION 2,5:?"*6;"PM GRAPHICS DEMO"
60 FOR I=1 TO 24:READ A:A$(I,I)=CHR$(A):NEXT I
70 DATA 169, 32,141,252,2,162,253,154,169,183,72,169,84,72,169,4,32,182,187,169,255,76,4,187
80 A=USR(ADR(A*))
```

get a black-and-white screen is to type Setcolor 2,0,0. The problem is that whenever you press System Reset you are back to blue again.

This three-line program simply sits in page 6 and sets black and white on System Reset. To set a different colour, change the second number in the Data statement. To change other registers, change the fourth and fifth numbers.

## Calendar improver

Philip Wade's useful and interesting calendar program was published on page 178 of the November issue — send an SAE for a photocopy. Since then he has seen an article on the interesting Atari technique of page flipping, and has used it to modify

the program. It now writes three screens at once, but into different parts of memory. To see what is happening, remove the Poke 559,0 in line 550. You can then flip through the screens using the Select key.

To amend the program simply load the original version and then add the 17 lines listed here, overwriting some of the original lines. Select and Option should be typed in inverse video. The routine could be used for game instructions, menus, etc.

## Tables turned on Atariwriter

I have just made a discovery that has changed my life. As everyone knows, Atariwriter is wonderful, but a real pig for handling tables. For tables, the best available tool is VisiCalc — but how shall the twain meet?

Simple. You just Print your VisiCalc file to disc, change to Atariwriter and load the resulting .PRF file. It still looks a mess but use the same parameters as VisiCalc, and it prints identically. You can preview the result using Option-P.

An added advantage is that you can use Atariwriter's Option-L command to load your VisiCalc table into the middle of your piece of word processing. You can double-space it using S4, and so on.

I don't know why I ever thought there was a problem!

### Calendar Improver.

```
90 PAGE=PEEK(106):FOR SCREEN=8 TO 24 SETEP 8:GOSUB 550:POKE 106,PAGE-SCREEN
100 POSITION 8,0:?" YEAR
290 POSITION 2,21:?"PRESS SELECT FOR DIFFERENT MONTHS"
295 POSITION 5,22:?"OR OPTION FOR ANOTHER YEAR."
300 DLSTLO(SCREEN)=PEEK(560):DLSTHI(SCREEN)=PEEK(561):NEXT SCREEN
310 POKE 559,34:FOR SCREEN=8 TO 24 STEP 8:POKE FKEY,8
320 POKE 560,DLSTLO(SCREEN):POKE 561,DLSTHI(SCREEN)
330 FOR DLY=1 TO 100:NEXT DLY
340 IF PEEK(FKEY)=3 THEN POKE 106,PAGE:RUN
350 IF PEEK(FKEY)=5 THEN 370
360 GOTO 340
370 NEXT SCREEN:GOTO 310
395 DIM DLSTLO(24),DLSTHI(24):FKEY=53279
500 GOSUB 550
510 TRAP 40000:GOTO 90
550 GRAPHICS 0:POKE 559,0:I=PEEK(560)+PEEK(561)*256+6:POKE I-3,70:POKE I,6
555 POKE 82,0:POKE 710,17:POKE 712,17:POKE 752,1:RETURN
```



# Centralex

**SPECIAL OFFERS  
MASSIVE DISCOUNTS  
STOCK  
TAKING CLEARANCE**

MODEL		Usual Price £	Our Price £	MODEL		Usual Price £	Our Price £
IBM	64K, Computer	2029	1439	EPSON	QX10	1730	1395
IBM	128K, 2 Drives	2552	1819	EPSON	HX20	411	349
IBM	128K, 2 Drives, D/S	2852	1980	EPSON	RX80	279	199
ACT	Sirius 1.2 MB	2195	1895	EPSON	RX80FT	319	239
ACT	Sirius 2.4 MB	2895	2495	EPSON	FX100	569	429
ACT	Sirius 10 MB	3995	3595	EPSON	FX80	438	329
ACT	Apricot, 1 Drive	1495	1345	ANADIX	9500B Printer	1045	849
ACT	Apricot, 2 Drives*	1750	1575	ANADIX	9501B Printer	1045	849
APPLE	Macintosh	Call	Call	ANADIX	9620B Printer	1155	889
APPLE	Lisa 2, 512K	2625	2100	ANADIX	WP6000 Printer	2195	1799
APPLE	Daisy Wheel Printer	1332	995	SHINWA	CP80 Printer	289	159
APPLE	Matrix Printer	425	349	TEXAS	820 KSR	1500	950
WICAT	512K, 10 Meg	9950	5950	COMMODORE	8032 Computer	895	595
DIABLO	Printer 630	1495	995				
TEXAS*	T1820 Printer	1350	875				

Telephone for latest prices, or call at our London Showroom.  
Packing and Delivery: £5 per unit UK, £20 worldwide.  
(Prices are exclusive of VAT)  
Maintenance contracts can be offered nationwide.

**Centralex-London Limited**  
8-12 Lee High Road, London SE13 5LQ  
Telephone: 01-318 4213/4/5/6/7  
Telex: 892622

● Circle No. 176

## aculab

## data buffers

FROM 16K TO 256K



Any combination of Parallel or Serial inputs and outputs, capacities 16k, 32k, 64k, 128k and 256k.  
Status indicator led's for data arriving, data present, buffer full etc.  
Buffer bypass facility for 'quick print' jobs, buffer repeat facility for multiple copies.  
Output hold facility to temporarily stop printing without destroying data.  
Separately selectable DTR, XON/XOFF, ETX/ACK handshaking, baud rate etc. on serial inputs and outputs.  
Serial input and output selection provides return data channel for KSR printers.  
Use for printer 'spooling', protocol conversions, data acquisition, machine monitoring etc.

For further information telephone or write to:

Parallel in—Parallel out	DB3-1	from .....	£186.00 (excl VAT)
Parallel in—Serial out	DB3-2	from .....	£197.00 (excl VAT)
Serial in—Parallel out	DB3-3	from .....	£197.00 (excl VAT)
Serial in—Serial out	DB3-4	from .....	£203.00 (excl VAT)
Parallel/Serial in and out	DB3-5	from .....	£221.00 (excl VAT)

**aculab Ltd.**  
Unit A, Station Approach,  
Leighton Buzzard,  
Beds. LU7 7LY.  
0525-371393

● Circle No. 125



# Pet animation

SIMPLE ANIMATION on the Pet can be achieved by rapidly regenerating a complete screenful of characters, each with a different frame drawn on it. Although it is not a difficult programming task, it can be cumbersome and requires machine code to regenerate the screen quickly enough.

G H Ryder of County Dublin has provided a relatively painless way to create such animation. Two programs are involved: Image Maker generates each frame and save it in the Pet's memory; Image Saver converts the frames into compacted Data statements and provides the routines to read the data into memory and perform the animation.

To save a sequence of frames, first load Image Maker. Without running the program, clear the screen and draw the first

frame of the sequence using the keyboard in the normal way, avoiding the top line as this is where the program issues its prompts.

When the screen is full, Home the cursor and run the program. It asks which image number you have just created and then stores the complete screen. This process should be repeated for each screenful. The residual Ready message will have to be deleted if it is intended to simply modify a previous frame, otherwise it will be incorporated into the screen's design.

Once all the images have been created, Run 200 puts the animation machine code into the cassette buffer, and Run 100 shows the animation sequence. You can then make any changes you need until the sequence is complete.

With the screen information stored in

memory, load the Image Saver program and run it to convert the screens into Data statements. Once all the Data statements have been created, the program deletes line 80 and modifies line 85 to show the total number of images. Lines 1900 to 2130 must be deleted by the user.

The program is self-contained with the sequence stored as data and there is no reason why it should not be modified and used within other programs. The speed of animation can be altered by changing the upper limit of K in lines 150 in the Maker program and 110 in the Saver program. Images are stored in 1,024-byte sections, working downwards from 30720 (\$7800) and the Data statements contain a compressed version of the screen, with each frame terminating with -1, -1.

## Image Maker.

```

10 REM*****
11 REM*
12 REM* FIRST CREATE IMAGE ON SCREEN.
13 REM* NEXT DO 'HOME', 'RUN' TO
14 REM* PLACE IMAGE IN MEMORY. CONTINUE
15 REM* UNTIL ALL IMAGES ARE FORMED.
16 REM* TO SEE ANIMATION OF IMAGES
17 REM* 'RUN200' TO PUT MACH CODE
18 REM* FOR ANIMATION INTO CASS BUFF.
19 REM* THEN 'RUN100' TO WATCH
20 REM* ANIMATION AND/OR MODIFY IMAGES
21 REM*
22 REM*****

25 INPUT "[HOME] INPUT ~SCREEN~IMAGE~NO.
   "; SN
30 PRINT "[HOME] ~~~~~~
   ~~~~~~"

35 B=30720-(SN-1)*1024
40 PRINT "[HOME] START~LOCATION="; B
50 FOR I=1 TO 500: NEXT
60 PRINT "[HOME] ~~~~~~
   ~~~~~~"

70 FOR I=0 TO 999: POKE B+I,
   PEEK(32768+I): NEXT
80 END

90 REM*****
95 REM* CHECK ANIMATION *
97 REM*****

100 INPUT "[CLEAR] TOTAL~NO.~OF~SCREEN~
   IMAGES"; NI

110 INPUT "DO~YOU~WISH~TO~CHANGE~ANY~I
   MAGE(Y~OR~N)"; A#
120 IF A#="N" GOTO 150
130 INPUT "WHICH~IMAGE~NUMBER"; SN
140 POKE 634, SN+1: SYS 635
   : PRINT "[HOME]"; END
150 FOR J=2 TO 1+NI: POKE 634, J
   : SYS(635): FOR K=1 TO 100: NEXT K
   : NEXT J: GOTO 150

190 REM*****
191 REM* LOAD MACH CODE FOR ANIMATION
192 REM* INTO MEMORY. NOTE THAT 634=
193 REM* $027A (CASS BUFF#1).
194 REM*****

200 S=634
260 E=S+45
265 READ A#: IF A#<>"MACH~CODE" GOTO 265

270 FOR L=S TO E
280 READ M: POKE L, M
290 NEXT
300 END

309 DATA MACH CODE
310 DATA 2, 173, 122, 2, 240, 39, 10, 10, 73
320 DATA 255, 56, 105, 128, 133, 137, 169, 0
330 DATA 168, 133, 136, 133, 138, 141, 122, 2
340 DATA 169, 128, 133, 139, 162, 4, 177, 136
350 DATA 145, 138, 136, 208, 249, 230, 137
360 DATA 230, 139, 202, 208, 242, 96

```

(continued on next page)

(continued from previous page)

Image Saver.

```

10 REM*****
20 REM*
25 REM*          IMAGE-SAVER
30 REM*
35 REM* 'RUN'PROGRAM TO SAVE IMAGES IN
40 REM* DATA STATEMENTS.THEN DELETE
45 REM* LINES 1900-2130 TO CREATE
50 REM* ANIMATION PROGRAM WHICH IS
55 REM* ALSO A LOADER FOR MACH CODE &
60 REM* IMAGE DATA. THE CORRECT NUMBER
70 REM* (NI) OF IMAGES APPEARS IN LINE
75 REM* 85 AND LINE 80 IS EDITED OUT
76 REM* AUTOMATICALLY.
77 REM*
78 REM*****

80 GOTO 2000
85 NI= 3
95 GOSUB 61000

100 REM*****
101 REM* ANIMATION BEGINS HERE
102 REM*****
105 POKE 665,177:POKE 666,136
   :POKE 668,138
110 FOR J=2 TO 1+NI:POKE 634,J
   :SYS(635):FOR K=1 TO 100:NEXT K
   :NEXT J:GOTO 110
120 END

1000 REM*****
1020 REM* LOAD MACH CODE INTO MEMORY
1030 REM* 634=#027A(CASS BUFF#1)
1040 REM*****

1050 S=634
1060 E=S+45
1065 READ A#: IF A#<>"MACH~CODE" GOTO
   1065
1070 FOR L=S TO E
1080 READ M:POKE L,M:
1090 NEXT
1100 RETURN

1109 DATA MACH CODE
1110 DATA 2,173,122,2,240,39,10,10,73
1112 DATA 255,56,105,128,133,137,169,0
1114 DATA 168,133,136,133,138,141,122
1116 DATA 2,169,128,133,139,162,4,177
1118 DATA 136,145,138,136,208,249,230
1120 DATA 137,230,139,202,208,242,96

1900 REM*****
1920 REM* MAKE DATA STATEMENTS OF
1930 REM* IMAGE CODE IN DECIMAL
1940 REM*****

2000 PRINT"[CLEAR]DATA~STATEMENT~GENE
   RATOR"
2010 INPUT"NUMBER~~OF~IMAGES";NI
2015 I=0
2020 IF I>NI-1 THEN GOTO 2120
2030 S=30720-I*1024:E=S+999
2040 L=63000+100*I
2050 PRINT"[CLEAR]"MID$(STR$(L),
   2)"DATA";:G=PEEK(54)+256*PEEK(55
   ):FL=0
2060 FOR J=S TO E
2070 IF POS(0)+PEEK(196)>70 THEN PRIN
   T"[LEFT]~":PRINT"[HOME,DOWN2]L=";
   L;"+1:S=";J;":E=";E;
2071 IF POS(0)+PEEK(196)>70 THEN PRIN
   T":I=";I;":NI=";NI; "~:GOTO";G
2080 IF POS(0)+PEEK(196)>70 THEN POKE
   623,19:POKE 624,13:POKE 625,13
   :POKE 158,3:END
2085 IF PEEK(J)=32 THEN GOTO 2100
   :REM* SKIP BLANKS
2090 PRINT MID$(STR$(PEEK(J)),2)",
   "MID$(STR$(J-30720+I*1024),2);",
   ";:FL=1
2100 NEXT J
2101 PRINT"[LEFT]~" :REM*DELETE TRAIL
   ING COMMAS
2102 IF FL=0 THEN PRINT"[CLEAR]":L=L-1
   :REM* DELETE EMPTY DATA STATEMEN
   TS
2103 PRINT MID$(STR$(L+1),2)"DATA-1,
   -1"
2105 PRINT"I=";I+1;":NI=";NI; "
   :GOTO2020"
2110 POKE 623,19:POKE 624,13
   :POKE 625,13:POKE 626,13
   :POKE 158,4:END
2120 PRINT"[CLEAR,DOWN18,RVS]
   DELETE~LINES~1900-2130[RVOFF]"
2125 PRINT"[RVS]AND~SAVE~WITH~TITLE~O
   F~ANIMATION[RVOFF]"
2130 PRINT"[HOME]80":PRINT"85~NI="NI
   :POKE 623,19:POKE 624,13
   :POKE 625,13:POKE 158,3:END

60500 REM*****
60520 REM* LOAD DATA STATEMENT CODE
60530 REM* FOR IMAGES BACK INTO MEMORY
60540 REM*****

61000 PRINT"[CLEAR]~~~~~[RVS]WAIT,
   IMAGE~CODE~BEING~READ~IN[RVOFF]"
61001 GOSUB 1050:FOR J=2 TO NI+1
   :POKE 634,J:SYS(635):NEXT J
61010 I=0
61035 S=30720-I*1024:IF I=NI GOTO 610
   80
61050 READ M1,M2:IF M1=-1 THEN I=I+1
   :GOTO 61035
61060 L=S+M2
61070 POKE L,M1:PRINT"[HOME]"L
   :GOTO 61050
61080 RETURN

```

# Deducity

A NOVEL GAME is submitted by Mr J Taylor of Teignmouth, last seen in this column with his Boolean tutorial. It allows the Apple to beat all comers at guessing, then spelling, the names of capital cities.

I am sure Mr Taylor has in no way bent the rules and biased the program toward selecting favourable circumstances for its own goes — at least, I can't see in the listing, where he could have done so — but it is curious that I only managed to win once in all my tries, when managing to select Rome, against the machine struggling to wade through Washington.

```

10 DIM TP$(30),TA(30),B(30)
20 DI = .0174533:RA = 50:BOX = 1:
   DDX = 1
30 D$ = CHR$(4)
40 REM PRINTD$: "BLOOD LETTERS
   TABLE"
50 HOME : HGR : TEXT
60 VTAB 3: HTAB 16: PRINT "DEDUC
   ITY.": HTAB 16: PRINT "=====
   =====": PRINT "PRINT "TEST.Y
   OUR GENERAL KNOWLEDGE AND SP
   ELLING"
70 PRINT : PRINT "INSTRUCTIONS. .
   ."
80 VTAB 11: PRINT " YOU WILL HAV
   E TWO LETTERS OF THE NAME"
90 PRINT "OF A SELECTED CAPITAL
   CITY.REMEMBER THE"
100 PRINT "LETTERS AND TRY TO DE
   DUCE AND SPELL THE"
110 PRINT "NAME BEFORE APPLE COM
   PLETES IT'S SIMILAR":
120 PRINT "TASK.YOU MAY SELECT E
   ACH LETTER WITH THE":
130 PRINT " SPACE BAR.YOU WILL
   BE IGNORED IF THE"
140 PRINT " LETTER CHOSEN IS I
   NCDRECT,AND THE"
150 PRINT "APPROPRIATE LETTER MA
   Y NOT NECESSARILY"
160 PRINT " BE AVAILABLE E
   ACH ROUND."
170 VTAB 21: PRINT "ANY KEY TO C
   ONTINUE ": GET G$
180 HOME
190 VTAB 10: HTAB 13: PRINT "JUS
   T A MINUTE..."
200 GOSUB 1830
210 READ DA: REM ND. OF DATA S
   TATEMENTS
220 FOR I = 1 TO DA: READ TP$(I)
   : NEXT
230 Z$ = "": S$ = ""
240 FOR I = 1 TO DA: REM REVERS
   E DATA STRINGS
250 D = LEN (TP$(I))
260 FOR MT = D TO 1 STEP - 1
270 Z$ = MID$(TP$(I),MT,1)
280 S$ = S$ + Z$
290 NEXT
300 TP$(I) = S$
310 S$ = "": Z$ = "": NEXT
320 HCOLOR=3
330 ROT=0: SCALE=1
340 START = PEEK (43634) + PEEK
   (43635) * 256: REM START 0
   F SHAPE TABLE
350 SHI = INT (START / 256)
360 SLO = START - 256 * SHI
370 POKE 232,SLO: POKE 233,SHI: REM
   HI-RES POINTER TO START OF
   SHAPE TABLE
380 GOSUB 930
390 I = INT (DA * RND (1)) + 1:
   TP$ = TP$(I):L1 = LEN (TP$)
400 PW$ = TP$
410 TP$(I) = ""
420 FOR I = 1 TO L1:WPLAYER$(I) =
   MID$(TP$,I,1): NEXT : REM
   PLACE SELECTED WORD IN PLAY
   ER ARRAY
430 TEMP$ = TP$
440 GOSUB 1060: REM PLOT TOP BOX
450 I = INT (DA * RND (1)) + 1:
   TP$ = TP$(I):L2 = LEN (TP$)
460 AW$ = TP$
470 IF TP$(I) = "" THEN 450
480 FOR I = 1 TO L2:WAPPLE$(I) =
   MID$(TP$,I,1): NEXT : REM
   PLACE SELECTED WORD IN AP
   PLE ARRAY
490 GOSUB 1100: REM PLOT BOTTOM
   BOX
500 TX$ = "LACITCARP":TS$ = "GNIT
   UPMOC"
510 LL = 4:MM = 115:NN = 275
520 FOR I = 1 TO 9
530 XDRAW (ASC (MID$(TX$,I,1)
   ) - 64) AT LL,MM
540 XDRAW (ASC (MID$(TS$,I,1)
   ) - 64) AT NN,MM
550 MM = MM - 10
560 NEXT
570 POKE - 16304,0: POKE - 162
   97,0: POKE - 16302,0: POKE
   - 16301,0
580 GOSUB 1260: REM RANDOM LETT
   ERS TOP BOX
590 GOSUB 1130: REM SPIN WHEEL
600 XDRAW 30 AT 25,130: REM DR
   AW FIG
610 XDRAW 27 AT 55,140
620 HOME
630 VTAB 21: PRINT " APPLE SEEKS
   EACH LETTER OF THE CHOSEN":
   PRINT "CITY (IN ORDER),FROM
   THE RANDOM LETTERS.": PRINT
   " --ANY KEY TO COMMENCE-
   ->": GET F$
640 FOR A = 0 TO 340 STEP 20
650 G = G + 1:SEL = TA(G)
660 GOSUB 900
670 REM DRAW AND DELETE LETTERS
680 GOSUB 1850
690 P = INT (3 * RND (1)) + 5: PO
   771,P: REM SOUND
700 FOR T = 1 TO 2: CALL 768: NEXT
   T
710 GOSUB 1850
720 REM CHECK LETTER AND IF MAT
   CH PRINT
730 IF CHR$(SEL + 64) = WAPPLE
   $(BOX) THEN XDRAW (ASC (WA
   PPLE$(BOX) - 64) AT L31 + (
   BOX * 15) - 15,143: PRINT "":
   W$ = W$ + WAPPLE$(BOX):WAPP
   LE$(BOX) = "":BOX = BOX + 1:
   GOTO 750
740 NEXT
750 IF W$ = AW$ THEN HOME : VTAB
   22: PRINT " *** APPLE
   WINS ***": PRINT " PL
   AYERS CITY WAS ":PW$: GOTO 1
   720
760 GOSUB 1850: GOSUB 1860
770 GOSUB 1850: GOSUB 1860
780 XDRAW 30 AT 25,130: REM CL
   EAR FIG
790 XDRAW 27 AT 55,140
800 HOME
810 GOSUB 1350: REM CLEAR ROUND
   TABLE
820 XDRAW 29 AT 240,35
830 XDRAW 27 AT 193,3
840 GOSUB 1130
850 GOSUB 1410: REM PLAYER SPIN
860 XDRAW 29 AT 240,35
870 XDRAW 27 AT 193,3
880 GOSUB 1350: REM CLEAR LETTE
   RS AFTER PLAYER SPIN
890 G = 0: GOTO 590
900 XA = SIN (DI * A) * RA
910 YA = COS (DI * A) * RA
920 RETURN
930 TX$ = "APPLE":TS$ = "PLAYER"
940 LL = 5:MM = 145
950 FOR I = 1 TO LEN (TX$): XDRAW
   (ASC (MID$(TX$,I,1) - 64
   ) AT LL,MM
960 LL = LL + 10: NEXT
970 LL = 215:MM = 5
980 FOR I = 1 TO LEN (TS$): XDRAW
   (ASC (MID$(TS$,I,1) - 64
   ) AT LL,MM
990 LL = LL + 10: NEXT
1000 RETURN
1010 X = PEEK (- 16384): IF X <
   > 160 THEN RETURN : REM
   NO SPACE BAR PRESS
1020 POKE - 16368,0
1030 GOSUB 1850
1040 POP
1050 GOTO 1510
1060 HPLOT 0,0 TO L1 * 15,0: HPL0T
   0,15 TO L1 * 15,15
1070 HPL0T 0,0 TO 0,15: HPL0T L1
   * 15,0 TO L1 * 15,15
1080 FOR I = 1 TO L1 - 1: HPL0T
   15 * I,0 TO 15 * I,15: NEXT
1090 RETURN
1100 HPL0T 125,154 TO 125 + (L2 *
   15),154: HPL0T 125,139 TO 12
   5,154: HPL0T 125 + (L2 * 15)
   ,139 TO 125 + (L2 * 15),154
1110 HPL0T 125,139 TO 125 + (L2 *
   15),139
1120 FOR I = 1 TO L2 - 1: HPL0T
   (15 * I) + 125,139 TO (15 *
   I) + 125,154: NEXT : RETURN
1130 FOR I = 1 TO 26:B(I) = 0: NEXT
   I
1140 REM SPIN WHEEL
1150 I = 1
1160 FOR A = 0 TO 340 STEP 20
1170 G = INT (26 * RND (1)) + 1
1180 IF B(G) = 99 THEN 1170
1190 TA(I) = G:I = I + 1
1200 B(G) = 99
1210 GOSUB 900
1220 XDRAW G AT 140 + XA,74 - YA
1230 NEXT A
1240 G = 0
1250 RETURN
1260 REM PLACE RAND LETTER IN
   TOP BOX TEMP
1270 I = INT (L1 * RND (1)) + 1
   :I1 = INT (L1 * RND (1)) +
   1
1280 BX = 6:BY = 5
1290 XDRAW (ASC (MID$(TEMP$,I
   ,1) - 64) AT BX + (I * 15) -
   15,BY
1300 XDRAW (ASC (MID$(TEMP$,I
   1,1) - 64) AT BX + (I1 * 15
   ) - 15,BY
1310 VTAB 21: PRINT "YOU HAVE A
   TWO LETTER CLUE TO A CITY.TR
   Y": PRINT " TO GUESS ITS N
   AME (NOTE THE LETTERS).": PRINT
   " --PRESS ANY KEY TO
   START->": GET F$: PRINT : HOME
1320 XDRAW (ASC (MID$(TEMP$,I
   ,1) - 64) AT BX + (I * 15) -
   15,BY
1330 XDRAW (ASC (MID$(TEMP$,I
   1,1) - 64) AT BX + (I1 * 15
   ) - 15,BY
1340 RETURN
1350 REM CLEAR ROUND TABLE
1360 FOR A = 0 TO 340 STEP 20
1370 GOSUB 900
1380 DRAW 28 AT 135 + XA,70 - YA
   : GOSUB 1850
1390 NEXT
1400 RETURN
1410 REM PLAYER SPIN
1420 VTAB 21: PRINT "SELECT YOUR
   CHOSEN LETTER IF AVAILABLE":
   PRINT " USING THE S
   PACE BAR.": PRINT " --
   ANY KEY TO START->": GET F$
   : PRINT
1430 FOR A = 0 TO 340 STEP 20
1440 G = G + 1:SEL = TA(G)
1450 GOSUB 900
1460 GOSUB 1850
1470 FOR TT = 1 TO 20: NEXT TT
1480 GOSUB 1010: REM SPACE BAR
   PRESS ?
1490 P = INT (3 * RND (1)) + 5:
   POKE 771,P: REM SOUND
1500 IF X < > 160 THEN FOR TT =
   1 TO 2: CALL 768: NEXT : GOSUB
   1850: GOTO 1540
1510 FOR T = 1 TO 3:TT = PEEK (
   - 16336): NEXT
1520 IF CHR$(SEL + 64) = WPLAY
   ER$(DOX) THEN XDRAW (ASC (
   WPLAYER$(DOX) - 64) AT 6 +
   (DOX * 15) - 15,5: FOR T = 1
   TO 9: CALL 768: NEXT T:W1$ =
   W1$ + WPLAYER$(DOX):WPLAYER$
   (DOX) = "":DOX = DOX + 1: GOTO
   1550
1530 GOSUB 1850: GOSUB 1850
1540 NEXT
1550 IF W1$ = PW$ THEN HOME : VTAB
   22: PRINT " *** PLAYE
   R WINS ***": PRINT " A
   PLES CITY WAS ":AW$: GOTO 1
   720
1560 HOME
1570 GOSUB 1850: GOSUB 1860
1580 FOR T = 1 TO 1000: NEXT
1590 GOSUB 1850: GOSUB 1860
1600 RETURN
1610 LL = 240:MM = 35:S = 29: REM
   REWARD
1620 GOSUB 1870
1630 FOR I = 1 TO 14
1640 GOSUB 1870
1650 FOR T = 1 TO 3: CALL 768: NEXT
   T
1660 GOSUB 1870
1670 MM = MM + 2.5
1680 LL = LL - 7
1690 NEXT
1700 GOSUB 1870
1710 GOTO 1810
1720 LL = 25:MM = 130:S = 30

```

(continued on page 165)

# MORE SHOCKING NEWS!

(limited period clearances)

EPSON Printers	from	£185
SHINWA Printers		£185
DISCS (BASF) 5" 25" & 8"		£1.00 each
DISC CASES (Holds 10)		£1.50 each
BBC Printer Leads		£10.00 each
DATAPRODUCTS 8010		Call for price
DAISYWHEEL Printers	from	£280

Phone 0962 66191 for

## MORE SHOCKING NEWS

- Nationwide delivery £5 per parcel.
- DISCS from £1.00

All prices ex VAT and subject to availability.

**micro miracles**

50A Stockbridge Road, Winchester, Hants  
SO22 6RL England

• Circle No. 179

**Sunshine's search for the computer writers of tomorrow is on...**

## Your name here? →

If you've ever seen yourself as a writer, and you've got the creativity and ideas to prove it, contact us now.

### **The search is on.**

Sunshine Books are the respected titles that sell well. That's why we're looking for the best. And we'll give you great rewards too. Extremely generous royalties, (paid every month), and lots of overseas potential.

### **Your idea or ours.**

We've got concepts here that we'd like worked up, now. Or tell us your ideas, and we'll let you know if you've got a winner. Call us soon.

We really can help you become an author.

### **Writers and/or programmers.**

At Sunshine, we can match writers to programmers, for really effective and innovative books. So good programmers should contact us now, too.

### **Fame and Fortune. For you?**

Write to David Lawrence, Sunshine books editor, with details of what you can offer, or ask us for more info at 12/13 Little Newport Street, London WC2R 3LD.



• Circle No. 180

(continued from page 163)

```

1730 GOSUB 1870
1740 FOR I = 1 TO 14
1750 GOSUB 1870
1760 FOR T = 1 TO 3: CALL 768: NEXT T

1770 GOSUB 1870
1780 MM = MM - 4: LL = LL + 8.5
1790 NEXT
1800 GOSUB 1870
1810 HTAB 12: PRINT "--AGAIN (Y/
N)->": GET F$: PRINT : IF F
$ = "Y" THEN CLEAR : GOTO 1
0

1820 END
1830 POKE 768,160: POKE 769,96: POKE
770,169: POKE 771,5: POKE 77
2,32: POKE 773,168: POKE 774
,252: POKE 775,173: POKE 776
,48: POKE 777,192: POKE 778,
136: POKE 779,208: POKE 780,
245: POKE 781,96

1840 RETURN
1850 XDRAW 28 AT 135 + XA,70 - Y
A: RETURN
1860 XDRAW 28 AT 134,70: RETURN

1870 XDRAW 8 AT LL,MM: RETURN
1880 DATA 29
1890 DATA NODNOL, STRAF, EMOR, KOK
GNAB, WDCSOM, EUGARP, ANNEIV, ML
DNKCOYS, NILBUD, NOBSIL, HCIRUZ
, SLESSURB, OLSO, NEGAHNEPOC, ED
ARGLEB, IKNISLEH

1900 DATA AMIL, TSEAHCLUB, NAMMA
, SUCSAMAD, ORIAC, DIRDAM, OTIUD
, SACARAC, ANAVAH, TURIEB, ARAKN
A, LUBAK, NOTGNTHSAM

1910 REM BY J.TAYLOR.WOODWAY CL
OSE, TEIGNMOUTH, DEVON. 1983

```

```

6000- 1E 00 3E 00 4D 00 59 00
600B- 63 00 4E 00 7A 00 84 00
6010- 91 00 9F 00 07 00 AF 00
601B- C0 00 C7 00 09 00 E8 00
6020- F3 00 FC 00 09 01 17 01
602B- 24 01 30 01 3A 01 43 01
6030- 50 01 5E 01 67 01 71 01
603B- 90 01 03 02 06 02 09 15
6040- 0E 36 36 07 58 38 3F 24
604B- 0C 96 1A 36 00 2D AD B6
6050- F6 3F 27 24 24 95 2D 06
605B- 00 29 AD 96 F2 3F 07 20
6060- 24 34 00 2D AD 36 36 1E
606B- 3F 27 24 24 06 00 2D 2D
6070- 96 3B 3F 24 96 36 2D 2D
607B- 06 00 2D 2D 96 3B 3F 24
6080- 96 36 06 00 29 2D B6 32
608B- 3E 3F 07 20 24 AC 4A 32
6090- 00 36 36 36 04 40 2D 35
609B- 36 04 58 58 20 34 00 29
60A0- F5 36 36 3E 0D 06 00 31
60AB- 36 36 1E 3F 07 30 00 36
60B0- 36 36 04 40 15 0E 15 04
60BB- 58 58 58 58 F0 17 06 00
60C0- 36 36 36 2D 2D 06 00 36
60CB- 36 36 44 21 64 35 36 36
60D0- 04 58 58 58 58 F8 13 06
60DB- 00 36 36 36 04 58 40 15
60E0- 0E 35 26 58 20 24 06 00
60EB- 29 AD 36 36 1E 3F 07 20
60F0- 24 34 00 2D AD F6 3F 27
60FB- B4 32 36 00 29 AD 36 B6
6100- 1F 3F 20 24 B4 89 0E 06
610B- 00 2D AD F6 3F 27 B4 32
6110- 66 09 15 07 C0 06 00 29
611B- AD 96 F6 3F 07 20 58 20
6120- 95 2D 06 00 2D 2E FE 36
612B- 36 FE 58 58 58 58 30 00
6130- 36 36 76 2D 05 20 24 24

```

```

613B- 06 00 36 0E 76 26 08 64
6140- 24 06 00 36 36 76 0D 05
614B- 20 24 24 96 18 36 06 00
6150- 76 0D 05 20 96 12 26 18
615B- 1F 17 26 48 30 00 76 0D
6160- 05 20 96 18 36 36 00 2D
616B- 2D F6 17 1E 17 2E 2D 35
6170- 00 49 29 2D 2D 05 0E 0E
617B- 0E 36 36 36 1E 1E 1E 1E
6180- 3F 3F 3F CC E3 1C 1C 24
618B- 24 24 0C 0C 0C 04 00 00
6190- 49 29 2D 2D 0E 3F 3F 3F
619B- F7 2D 2D 2D 2D 35 FD 3F
61A0- 3F 3F 3F F7 2D 2D 2D 2D
61AB- 2D 2D 2D 1C 0F 18 0F 18
61B0- 0F 18 4D 91 92 3F 3F 3F
61BB- 3F 3F 3F 2E 2D 2D 2D 3F
61CB- 2D 2D 2D F5 FD 3F 3F 3F
61DB- 3F 3F 3F 2E 2D 2D 2D 2D
61E0- 2D 2D 35 3F 3F 3F 3F 3F
61EB- 3F 3F 0E 2D 2D 2D 2D 2D
61ED- 2D 1E 3F 3F 3F 3F 3F 0E
61EB- 2D 2D 2D 1E 3F 3F 3F 3F
61FD- CE 08 08 18 18 70 0E 0E
61FB- 0E 2D 2D 2D 1C 09 0C 0C
6200- 0C 04 00 3C 3F 2D 2D 2D
620B- 64 E4 3C 3C 3F 17 1E 36
6210- 76 96 36 36 36 36 27 24
621B- 24 04 20 3F 3F 24 24 24
6220- 4D 49 0D 4D 49 31 36 1E
622B- 36 36 3E 20 24 1E 3F 36
6230- 36 36 3E 3F 27 24 24 24
623B- 2D 36 36 36 27 24 24 0D
6240- 36 36 B6 FF 4D 09 24 0D
624B- 24 28 04 58 58 58 58 58
6250- 40 09 24 DF DB DB DB 0E
625B- 92 92 32 3F 27 2D 16 00
6260- FF 24 AC 36 36 16 36 36
626B- 36 2D DF 3B 67 21 24 24
6270- 04 20 24

```

```

JLOAD DRACULA
JLIST

4 REM *****
****
5 REM *** DRACULA
***
6 REM *** BY : NILESH PATEL
***
7 REM *** DATE : 20/10/83
***
8 REM *** COMP. : APPLE II
***
9 REM *** LANG. : APPLESOFT
***
10 REM *****
****
15 CLEAR
20 HOME : PRINT : PRINT : INPUT
"WANT INSTRUCTIONS ? "; YN$
22 IF YN$ = "Y" THEN 700
23 IF YN$ = "N" THEN 90
79 REM *** PLOT MAZE ***
90 TEXT : GR : HOME : A = FRE (0
): POKE 216,0
95 MC = 15
100 COLOR= 9: HLIN 0,39 AT 0: VLIN
1,39 AT 39: HLIN 38,0 AT 39:
VLIN 38,1 AT 0
110 HLIN 1,5 AT 5: HLIN 38,34 AT
5: VLIN 2,4 AT 5: VLIN 2,4 AT
34: HLIN 1,5 AT 34: HLIN 38,
34 AT 34: VLIN 35,37 AT 5: VLIN
35,37 AT 34
120 HLIN 15,24 AT 15: HLIN 15,24
AT 24: VLIN 16,18 AT 15: VLIN
16,18 AT 24: HLIN 21,23 AT 1
5: VLIN 21,23 AT 15: VLIN 21
,23 AT 24
130 HLIN 12,18 AT 12: HLIN 21,27
AT 12: HLIN 12,18 AT 27: HLIN
21,27 AT 27: VLIN 13,26 AT 1
2: VLIN 13,26 AT 27
140 HLIN 9,30 AT 9: HLIN 9,30 AT
30: VLIN 10,18 AT 9: VLIN 10
,18 AT 30: VLIN 21,30 AT 9: VLIN
21,30 AT 30
150 HLIN 8,6 AT 18: PLOT 8,21: VLIN
19,21 AT 6: HLIN 31,33 AT 18
: PLOT 31,21: VLIN 19,21 AT
33
155 REM *** PLOT COFFINS ***
160 COLOR= 7: PLOT 17,17: PLOT 2
2,17: PLOT 17,22: PLOT 22,22
165 REM *** PLOT MAN ***
170 XM = INT ( RND (1) * 39): YM =
INT ( RND (1) * 39): IF SCRN(
XM, YM) = 9 OR SCRN( XM, YM) =
10 THEN 170
175 IF SCRN( XM, YM) = 9 THEN 49
0
176 REM *** PLOT MONS. ***
180 PLOT MX, MY: COLOR= 9: MX = INT
( RND (1) * 39): MY = INT ( RND
(1) * 39): IF SCRN( MX, MY) =
9 THEN 180
185 IF SCRN( MX, MY) = 8 THEN 18
0
190 COLOR= 10: PLOT MX, MY
200 COLOR= 15: PLOT XM, YM
210 COLOR= 7: PLOT 1,1: PLOT 1,3
8: PLOT 38,1: PLOT 38,38
220 COLOR= MC: PLOT XM, YM

```

```

225 IF DK > = 4 THEN 500
226 REM *** MOVE MEN ***
230 Q = PEEK ( - 16384)
240 IF Q = 193 THEN GOTO 290
250 IF Q = 211 THEN GOTO 310
260 IF Q = 215 THEN GOTO 330
270 IF Q = 218 THEN GOTO 350
280 GOTO 230
290 IF SCRN( XM - 1, YM) = 9 THEN
230
291 IF SCRN( XM - 1, YM) = 7 AND
MC = 12 THEN 230
292 IF SCRN( XM - 1, YM) = 7 THEN
XM = XM - 1: MC = 12: COLOR=
0: PLOT XM + 1, YM: COLOR= 0:
GOTO 180
294 IF SCRN( XM - 1, YM) = 8 AND
MC = 12 THEN MC = 15: XM = XM
- 1: COLOR= 0: PLOT XM + 1,
YM: DK = DK + 100: COLOR= 0: GOTO
180
295 IF SCRN( XM - 1, YM) = 8 AND
MC = 15 THEN 520
296 IF SCRN( XM - 1, YM) = 10 THEN
510
298 XM = XM - 1: COLOR= 0: PLOT X
M + 1, YM: COLOR= 0: GOTO 180
310 IF SCRN( XM + 1, YM) = 9 THEN
230
311 IF SCRN( XM + 1, YM) = 7 AND
MC = 12 THEN 230
312 IF SCRN( XM + 1, YM) = 7 THEN
XM = XM + 1: MC = 12: COLOR=
0: PLOT XM - 1, YM: GOTO 270
314 IF SCRN( XM + 1, YM) = 8 AND
MC = 12 THEN MC = 15: XM = XM
+ 1: COLOR= 0: PLOT XM - 1
, YM: DK = DK + 1: COLOR= 0: GOTO
180
315 IF SCRN( XM + 1, YM) = 8 AND
MC = 15 THEN 520
316 IF SCRN( XM + 1, YM) = 10 THEN
510
318 XM = XM + 1: COLOR= 0: PLOT X
M - 1, YM: COLOR= 0: GOTO 180
330 IF SCRN( XM, YM - 1) = 9 THEN
230
331 IF SCRN( XM, YM - 1) = 7 AND
MC = 12 THEN 230
332 IF SCRN( XM, YM - 1) = 7 THEN
YM = YM - 1: MC = 12: COLOR=
0: PLOT XM, YM + 1: COLOR= 0:
GOTO 180
334 IF SCRN( XM, YM - 1) = 8 AND
MC = 12 THEN MC = 15: YM = YM
- 1: DK = DK + 1: COLOR= 0: PLOT
XM, YM + 1: COLOR= 0: GOTO 18
0
335 IF SCRN( XM, YM - 1) = 8 AND
MC = 15 THEN 520
336 IF SCRN( XM, YM - 1) = 10 THEN
510
338 YM = YM - 1: COLOR= 0: PLOT X
M, YM + 1: COLOR= 0: GOTO 180
350 IF SCRN( XM, YM + 1) = 9 THEN
230
351 IF SCRN( XM, YM + 1) = 7 AND
MC = 12 THEN 230
352 IF SCRN( XM, YM + 1) = 7 THEN
YM = YM + 1: MC = 12: COLOR=
0: PLOT XM, YM - 1: COLOR= 0:

```

## Dracula

The familiar picture of four stakes in the corner towers, four coffins in the centre tower, and doors and corridors are all included in this version of Dracula from Nilesh Patel of Croydon. Getting the right stakes to the right coffins involves juggling with the keyboard and trying not to overshoot the correct line of approach, since creeping up to the wrong coffin makes for a very quick end to the game.

```

GOTO 180
354 IF SCRN( XM, YM + 1) = 8 AND
MC = 12 THEN MC = 15: YM = YM
+ 1: DK = DK + 1: COLOR= 0: PLOT
XM, YM - 1: COLOR= 0: GOTO 18
0
355 IF SCRN( XM, YM + 1) = 8 AND
MC = 15 THEN 520
356 IF SCRN( XM, YM + 1) = 10 THEN
510
358 YM = YM + 1: COLOR= 0: PLOT X
M, YM - 1: COLOR= 0: GOTO 180
360 REM *** SCORE ***
490 TEXT : HOME : PRINT "ONE OF
DRACULA'S GANG HAS KILLED YO
U": GOTO 600
500 TEXT : HOME : PRINT "YOU KIL
LED DRACULA": GOTO 600
510 TEXT : HOME : PRINT "YOU HAV
E BEEN KILLED BY THE MONSTER
!": GOTO 600
520 TEXT : HOME : PRINT "YOU HAV
E BEEN KILLED BY COUNT DRACU
LA!!"
600 DK = DK * 1000: PRINT : PRINT
"YOUR SCORE = > " DK
630 PRINT : PRINT : INPUT "ANOT
HER GAME <Y/N> ? "; Y$
635 IF Y$ = "Y" THEN 15
650 IF Y$ = "N" THEN END
680 END
690 REM *** INSTRUCTIONS ***
700 HOME : VTAB 2: HTAB 16: PRINT
"DRACULA": PRINT : PRINT
710 PRINT "THE OBJECT OF THIS GA
ME IS TO KILL": PRINT : PRINT
"DRACULA OR THE MONSTER WILL
GET YOU.": PRINT : PRINT "Y
OU COLLECT YOUR STAKES FROM
ONE OF THE"
720 PRINT : PRINT "TOWERS IN THE
CORNERS. YOU MUST DESTROY": PRINT
: PRINT "ALL THE COFFINS TO
ELIMINATE DRACULA."
722 PRINT : PRINT " A = LEFT S
= RIGHT W = UP Z = DOWN"
730 PRINT : INVERSE : HTAB 7: INPUT
"HIT ' RETURN ' WHEN READY";
R$: NORMAL
740 IF R$ < > "" THEN 700
750 IF R$ = "" THEN 90
760 END

```

# reprints

If you are interested in a particular article/special feature or advertisement in this journal **HAVE A GOOD LOOK AT OUR REPRINT SERVICE!**

We offer an excellent, reasonably priced service working to your own specifications to produce a valuable and prestigious addition to your promotional material. (Minimum order 250 copies).

Telephone Michael Rogers on 01-661 3457 or complete and return the form below.

To: Michael Rogers, Practical Computing, Reprint Department, Quadrant House, Sutton, Surrey SM2 5AS.

I am interested in ..... copies of article/advert. headed ..... featured in this journal on pages ....., issue dated ..... Please send me full details of your reprint service by return of post.

Name .....  
 Company .....  
 Address .....  
 Tel No .....

## THE INSTITUTION OF ANALYSTS & PROGRAMMERS



An association which is widely recognised and respected, endorses the status of its members, protects and promotes their interests, assists their careers and encourages their ethical standards is the foundation of every profession.

The Institution of Analysts & Programmers is the leading association for those who use, develop and organise systems analysis and computer programming for Commerce, Industry or Public Service as a principal or supplementary part of their professional life. Awareness of the Institution and the high regard accorded to its members has brought inquiries and applications from over forty independent countries and states.

The essential qualification for election is practical experience but grading allowances are made for degrees, diplomas and course certificates of recognised universities and training organisations and for memberships of other professional associations and learned bodies. A guide to membership requirements and gradings may be requested by telephone or letter addressed to the Applications Department.

01-898 2385

The Institution Of Analysts & Programmers  
 GIBSON HOUSE, FOURTH CROSS ROAD, TWICKENHAM  
 MIDDLESEX, TW2 5EL, ENGLAND

● Circle No. 253

# SWAP MICRO TO MICRO FILE TRANSFER SYSTEM

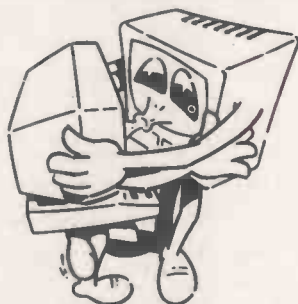

"Get your microcomputers talking to each other!"

SWAP allows you to transfer any programs and data between 2 computers of different manufacture. SWAP consists of 2 floppy disks and a cable configured for your 2 chosen computers. Any combination is available from:

IBM PC	Apple (CP/M)	Tandy II (CP/M)
Sirius	DEC Rainbow	Comart Communicator
Apricot	ICL PC	Epson QX10
Superbrain	Rair	ECS 4500
Televideo	North Star Advantage	

The price of SWAP is £158 (£135 plus VAT and postage and packing). Please specify your computers when ordering.

MERCATOR COMPUTER SYSTEMS LTD  
 3 Whiteladies Road, Clifton, Bristol BS8 1NU.  
 Telephone: (0272) 731079  
 Telex 44220 Comtel Ref 247

MERCATOR  
 COMPUTER SYSTEMS

● Circle No. 182

# MICRO-DIGITAL

## THE BRITISH S100 SPECIALISTS

Micro-Digital Engineering was set up to provide a source of British S100 products. In addition to our rapidly expanding standard range, we undertake specialist design work for both S100 and non-S100 products. Contact us for details.

### COMPUTER SYSTEMS

<b>8 BIT SYSTEMS</b> DM8000 280A processor with 64k RAM from £1,950	<b>DUAL 8/16 BIT SYSTEMS</b> DM8100 280A - 8/16 processor, 256k Dynamic RAM from £2,450
<b>FULL 16 BIT SYSTEMS</b> DM8200 8086 processor 256k Dynamic RAM from £2,750	<b>MULTI-USER SYSTEMS</b> from £2,500

### S100 BOARDS

<b>PROCESSOR BOARDS</b> Lightning One 8086 or 8088 CPU 88 280A - 8088 £265 LDP MDE S88M Z80A £189 MDE T-68000 68000 £675 IMP	<b>MEMORY</b> DRAM2 - 256k 64k SRAM - 64k 64k SRAM - 32k LDP 256k T256k DRAM for T-68000 T-1M 1 Megabyte	£555 MDE £295 MDE £225 MDE £795 MDE £775 IMP £3,000 IMP
<b>COMMUNICATIONS</b> COMBO 1 Serial Parallel I/O, Clock Cal £245 MDE Hazrat Serial Parallel I/O, Clock Cal £299 LDP S104 4 channel serial I/O £149 MDE T-58 8 channel serial I/O £875 IMP	<b>DISK I/O</b> FDC up to 4.5" or 5.25" Floppies DAVID JNR (not S100, 5.25" drive, 31000) KONAN W1000 INTERFACE	£175 MDE £295 KDN £85 KDE
<b>ANALOGUE BOARDS</b> 12 A/D 1.32 channel with amp £615 DUL 12 A/D 2 as above without amp £565 DUL 12 A/D 12 bit 4 channel £590 DUL	<b>OTHER BOARDS</b> P & T 488 IEEE 488 Interface TERM 40 Active Termination	£460 P&T £48 KDE

### ANCILLIARIES

<b>MOTHER BOARDS - ASSEMBLED</b> 6 Slot £75 MDE 15 Slot £135 MDE	<b>CARD CAGES - COMPLETE WITH MOTHER BOARD</b> 6 Slot £107 MDE 15 Slot £185 MDE
<b>FRAMES</b> DM8000 15 Slot 2 full height drive cut-outs £495 MDE	<b>BARE DRIVES - HALF HEIGHT</b> Epson FT521 5.25" DS48TPH £185 Epson FT540 5.25" DS48TPH £230 NEC 8" DS DD £370
<b>S100 POWER SUPPLIES</b> from £95 MDE	<b>TAPE STREAMER</b> Ciplex S25CT 5.25" Floppy compatible £550

NOTE: All prices exclude delivery & VAT

FOR DETAILS RING 0908 310896 NOW!

Distributor and Dealer enquiries welcome

**MICRO-DIGITAL Engineering**  
 a division of SOLHURST COMPUTERS LIMITED

5 Castlefields, Bancroft, Milton Keynes, MK13 0PS England Tel National 0908 310896 International +44 908 310896

● Circle No. 183

# Spectrum spreadsheet

COMPUTERS are only a collection of transistors soldered on to a board and connected to a keyboard. They are quite useless without a program to give them life, and the type of program which gave the computer more life than any other was the spreadsheet.

Ever since VisiCalc was written for the Apple way back in 1979, similar programs have been written for practically every breed of computer. The program sent in by A M Tucker of Charminster, Dorset is not the first Spectrum spreadsheet, and he acknowledges that it is based on Brian Low's program for the ZX-81 published in PC in July 1983. However, it includes some

modifications and improvements which take advantage of the additional facilities available on the Spectrum.

The program was supplied by Mr Tucker in a non-running form. An extra line

20 LET f=50: GO TO 2200

must be added so that it runs. The spreadsheet is restricted to 32 rows with columns limited only by available memory.

When using the D or Delete command the specified column must be visible on the screen, but the rows to be deleted need not be. When using the V command to enter a single value the relevant column and row must be visible.

The commands C, S and H can be used

on any column, whether visible or not. In line 2310, A\$ is dimensioned to A\$(NC, 50) to hold the formula. For very long formulae this Dim should be increased.

Pressing M produces the menu and command table which, amongst other things, enables the program to be saved. If the program is already saved on tape with a backup copy, option 5 can be deleted.

A full documentation of this program would take up more space than we can afford, but basic instructions are displayed as the program is being run. As with many programs of this sort, the most effective way to learn its capabilities and limitations is to use it.

```

10 REM SPECTRUM FORMCALC
   By A.M.Tucker, Charminster.
   (From program by Brian Low)
29 REM Enter individual values
30 INPUT "Enter column no. - "
;cn: IF cn>nc THEN GO TO 30
40 LET c=cn: LET v=c-s: FOR r=
1 TO nr: LET rp=r-t: LET a$(c)="
q(r,c)"
50 LET j=(rp>0 AND v>0 AND v<=
cv)
60 IF j AND rp>16 THEN GO SUB
1900
70 IF j THEN PRINT AT rp+2,c(v
);"*"
80 INPUT "Enter value - ";q(r
,c)
90 IF j THEN GO SUB prt
100 NEXT r: LET r=t: GO TO cmd
199 REM Print routines
200 LET r=n: LET rp=18
210 LET i=(INT (q(r,c)*g+.5))*h
220 PRINT AT rp+2,c(v)-(cv>4);T
AB (c(v)+4+(7-cv)*i(cv<5)): IF i=
0 THEN RETURN
230 PRINT AT rp+2,c(v)-(i<0);",
" AND ABS i<1e3;" AND ABS i<10
0;" AND ABS i<10;i
240 RETURN
299 REM Col/row no. printing
300 PRINT AT 0,0;nr;"R";TAB 16;
nc;"C"
310 FOR i=0 TO 31: PRINT "=";:
NEXT i
320 FOR i=1 TO cv: LET c(i)=i*I
NT (24/cv+.83)-12/cv: PRINT AT 1
,c(i)+2;"C";i+5: NEXT i
340 PRINT AT 2,0;"Row": FOR i=1
TO 16: LET r=r+1: PRINT " AND
r<10;r: IF r>nr THEN GO TO 360
350 NEXT i
360 LET r=t: RETURN
399 REM Column headings
400 INPUT "Column no.? - ";c: I
F c>nc THEN GO TO 400
410 INPUT "Heading ? - ";h$(c)
420 LET v=c-s: IF v<1 OR v>cv T
HEN GO TO cmd
430 GO SUB 500: GO TO cmd
499 REM Print headings
500 PRINT AT 2,c(v)+1;h$(c): RE
TURN
599 REM Clear worksheet
600 LET r=0: LET t=0: LET i$=""
: FOR i=1 TO nc: FOR j=1 TO nr:
LET q(j,i)=0: NEXT j: IF q(n,i)<
>0 THEN LET q(n,i)=.1#h
610 NEXT i: GO TO 2320
699 REM Sum value of a column
700 INPUT "Column no. to be sum
med? - ";c: IF c>nc THEN GO TO 7
00
710 LET v=c-s: LET q(n,c)=0
720 FOR i=1 TO nr: LET q(n,c)=q
(n,c)+q(i,c): NEXT i
730 IF v>0 AND v<=cv THEN GO SU
B 200
740 LET r=t: GO TO cmd-570*(i$=
"a")
799 REM No. of cols. visible
800 PRINT #0;AT 0,0;"How many c
ols. seen (max.4/6)?",,,, LET c$
=INKEY$
810 IF c$<"1" OR c$>"6" THEN GO
TO 800
820 IF VAL c$>nc THEN GO TO 800
830 IF VAL c$=cv THEN GO TO cmd
840 LET cv=VAL c$: LET s=0: GO
TO 1320
1099 REM Change/delete value
1100 LET x$="y": INPUT "Enter co
lumn no. - ";c: IF c<=s OR c>cv+
s THEN GO TO 1100
1110 IF a$(c, TO 6)<>"q(r,c)" AN
D a$(c, TO 2)<>" THEN PRINT #
0;"O.K. delete formula? (y/n)-":
PAUSE 0: LET x$=INKEY$
1120 IF x$<>"y" THEN GO TO cmd
1130 LET v=c-s: IF i$="d" THEN G
O TO 1200
1140 INPUT "Enter row no. - ";r:
IF r<=t OR r>t+16 OR r>nr THEN
GO TO 1140
1150 INPUT "New value - ";q(r,c)
1150 LET rp=r-t: LET a$(c)="q(r,
c)"
1170 IF rp<17 THEN GO SUB prt
1180 LET r=t: GO TO cmd-1620*(q(
n,c)<>0)
1199 REM Delete part/whole col.
1200 INPUT "Delete from row - "
;rf;" to - ";rl: IF r>nr OR rl>
nr THEN GO TO 1200
1210 LET a$(c)="q(r,c)": LET i=r
p
1220 FOR r=r TO rl: LET q(r,c)=
0: LET rp=r-t: IF rp<17 THEN GO
SUB prt
1230 NEXT r: LET rp=i
1240 IF q(n,c)<>0 THEN GO TO 710
1250 LET r=t: GO TO cmd
1299 REM Left/right shift
1300 IF (i$="5" AND s)=nc-cv) OR
(i$="8" AND NOT s) OR (NOT t AN
D i$="t") OR ((t)=nr-16 OR nr<17
) AND i$="b") THEN GO TO cmd
1310 LET s=s+(i$="5")-(i$="8")*5
GN s: IF i$="b" OR i$="t" THEN L
ET t=(nr-16)*(i$="b"): LET r=t

```

(continued on next page)

(continued from previous page)

```

1320 LET j=(i$="t" OR i$="b" OR
i$="u")
1330 POKE 65507,22-j: RANDOMIZE
USR 65506: GO SUB 300+40*j
1340 FOR c=s+1 TO s+cv
1350 LET v=c-s: IF h$(c, TO 2)<>
" " AND NOT j THEN GO SUB 500
1360 IF a$(c, TO 2)=" " THEN GO
TO 1400
1370 FOR r=t+1 TO t+16: LET rp=r
-t: IF r>nr THEN GO TO 1400
1380 IF q(r,c)<>0 THEN GO SUB pr
t
1390 NEXT r: IF q(n,c)<>0 THEN G
O SUB 200
1400 LET r=t: NEXT c: GO TO cmd
1499 REM Shift n cols. r/t
1500 INPUT "Enter column to be r
irst - ";cf: IF cf>nc THEN GO TO
1500
1510 IF cf>nc-cv+1 THEN LET cf=nc
-cv+1
1520 IF s=cf-1 THEN GO TO cmd
1530 LET s=cf-1: GO TO 1320
1599 REM Formula entry
1600 INPUT "Enter column no. - "
;c: IF c>nc THEN GO TO 1600
1610 INPUT "Enter formula - ";a$
(c): GO SUB 1800
1620 LET v=c-s: FOR r=1 TO nr: L
ET rp=r-t
1630 LET q(r,c)=VAL a$(c)
1640 IF v>0 AND v<cv AND rp>0 A
ND rp<17 THEN GO SUB prt
1650 NEXT r: LET r=t: IF a$(c,1)
="r" AND a$(c,2)=" " THEN LET a$
(c)="q(r,c)"
1660 IF q(n,c)<>0 THEN GO TO 710
1670 GO TO cmd
1899 REM Recalculation
1700 PRINT #0;AT 0,0,,,,: FOR c=
1 TO nc: LET v=c-s
1710 IF a$(c, TO 6)="q(r,c)" OR
a$(c, TO 2)=" " THEN GO TO 1750
1720 FOR r=1 TO nr: LET rp=r-t:
LET i=q(r,c)
1730 LET q(r,c)=VAL a$(c): IF i<
>q(r,c) AND rp>0 AND rp<17 AND v
>0 AND v<cv THEN GO SUB prt
1740 NEXT r: LET r=t
1750 IF q(n,c)<>0 THEN GO SUB 71
0
1760 NEXT c: GO TO cmd
1799 REM Formula encode
1800 LET i=1: LET b$=a$(c): LET
c$=" "
1810 IF i=LEN b$+1 THEN LET a$(c
)=c$: RETURN
1820 IF b$(i)<="p" THEN LET a$(c)
="q(r,c-1)+(r<>1)*q(r-(r<>1),c)"
: GO TO 1610
1830 IF b$(i)<>"c" AND b$(i)<>"s
" THEN LET c$=c$+b$(i): LET i=i+
1: GO TO 1810
1840 LET x$="r": IF b$(i)<>"c" T
HEN LET x$="n"
1850 LET c$=c$+"q("x$+", "+b$(i+
1)
1860 IF b$(i+2)<>"*" AND b$(i+2)
<>"/" AND b$(i+2)<>"^" AND b$(i+
2)<>"+ " AND b$(i+2)<>"-" THEN LE
T c$=c$+b$(i+2): LET i=i+1
1870 LET c$=c$+")": LET i=i+2: G
O TO 1810
1899 REM Scroll routines
1900 IF t+17>nr THEN GO TO cmd
1910 LET t=t+1: LET r=16+t
1920 PRINT AT 20,0,,#0;AT 0,0,
,,: RANDOMIZE USR 65500: PRINT A
T 18,0,r
1930 FOR c=s+1 TO s+cv: IF a$(c,
TO 2)=" " THEN GO TO 1950
1940 LET v=c-s: LET rp=16: GO SU
B prt: IF (i$="7" OR (r=nr) AND q
(n,c)<>0 THEN GO SUB 200: LET r=
16+t
1950 NEXT c: IF i$="c" THEN LET
v=cn-s: LET c=cn: RETURN
1960 LET r=t: GO TO cmd
1999 REM Shell Metzner sort
2000 INPUT "Enter column to be s
orted - ";c: IF c>nc THEN GO TO
2000
2010 INPUT "Reorder from col. -
";cf;": to - ";cl: IF cf>nc OR c

```

```

) >nc THEN GO TO 2010
2020 LET r=1
2030 IF 2*(r>nr) THEN GO TO 2050
2040 LET r=r+1: GO TO 2030
2050 LET j=2*(r-1)
2060 LET j=INT (j+.5): IF j=0 TH
EN LET r=t: GO TO 1320
2070 LET i=nr-j: LET b=1
2080 LET r=b
2090 LET e=r+j: IF q(r,c)>q(e,c)
THEN GO TO 2110
2100 LET b=b+1: GO TO 2080-20*(b
>i)
2110 FOR w=cf TO cl: LET m=q(r,w
): LET q(r,w)=q(e,w): LET q(e,w)
=m: NEXT w
2120 LET r=r-j: GO TO 2090+10*(r
<1)
2199 REM Initialise
2200 RESTORE : FOR i=65500 TO 65
511: READ a: POKE i,a: NEXT i: L
ET cmd=2330: LET prt=210: DATA 6
,20,205,0,14,201,6,22,205,68,14,
201
2210 CLS: PRINT TAB 5;"FORMCALC
Commands:-" "c - Enter colum
n of data" "v - Change one value
in column" "d - Delete part/who
le col." "n - Change column spac
ing" "h - Enter column heading"
2220 PRINT "f - Enter formula"
s - Sub column" "u - Sort column
(low to high)" "a - Recalculate
; left to right" "7 - Scroll up
(from row 16)"
2230>PRINT "5 - Shift left" "8 -
Shift right" "w - Move n column
s right/left" "b - Bottom 16 row
s" "t - Top 16 rows" "m - Menu a
nd command listing"
2240 GO TO 2250+1
2250 PRINT #0;AT 0,0;"Choose: - 1
.New worksheet.";TAB 9;"2.Old wo
rksheet.";TAB 9;"3. Do ,blank + f
ormulae.";TAB 9;"4.Save program
& data.";TAB 9;"5.Save program o
nly."
2260 IF CODE INKEY$<49 OR CODE I
NKEY$>53 THEN GO TO 2260
2270 LET a=VAL INKEY$: LET i$=" "
: CLS
2280 IF a=2 THEN LET r=t: GO TO
1320
2290 GO TO 2300-1790*(a=3)+210*(
a>3)-10*(a=5)
2300 INPUT "No. of rows reqd.(ma
x.32)? - ";nr:"No. of columns?
- ";nc:"How many to be visible
? - ";cv:"No. of decimal places?
- ";d
2310 LET n=nr+1: DIM a$(nc,50):
DIM h$(nc,7): DIM q(n,nc): DIM c
(nc): LET a=10+d: LET h=12+d
2320 LET f=0: LET r=0: LET t=0:
LET s=0: CLS: GO SUB 300
2330 PRINT #0;AT 0,0;"Command?";
" c-v-d-n-h-f-s-u-a-7-5-8-w-b-t
-m"
2340 IF INKEY$=" " THEN GO TO 234
0
2350 LET i$=INKEY$: IF (i$="t" O
R i$="b") AND nr<17 THEN GO TO c
md
2360 IF i$="5" OR i$="8" OR i$="
b" THEN GO TO 1300
2370 GO TO 2380-1990*(i$="h")-16
00*(i$="s")-1580*(i$="n")-1260*(
i$="v" OR i$="d")-1060*(i$="t")-
680*(i$="w")-780*(i$="f")-680*(i
$="a")-480*(i$="7")-380*(i$="u")
-170*(i$="m")
2380 IF i$<>"c" THEN GO TO cmd
2390 GO TO 30
20499 REM Saving
20500 CLEAR: LET f=50
20510 PRINT AT 11,12; BRIGHT 1;"S
AVING": SAVE "formcalc" LINE 220
0
20520 PRINT AT 11,2;"To verify, r
ewind tape & run."
20530 VERIFY "formcalc"
20540 CLS: PRINT AT 11,0;TAB 7;"
O.K. Switch off tape."

```





# ORYX SYSTEMS (U.K.) LIMITED

## MICROCOMPUTER HARDWARE, SOFTWARE AND ACCESSORIES WITH FULL AFTER SALES SUPPORT

### CP/M SOFTWARE

<b>ASHTON TATE</b>	
D Base II*	£335
Friday*	£170
<b>CAXTON</b>	
Cardbox*	£185
<b>COMPSOFT</b>	
Compsoft DMS*	£190
DMS Delta*	£495
<b>DIGITAL RESEARCH</b>	
Access Manager	£195
Access Manager -86*	£270
Display Manager	£270
Display Manager -86*	£334
C Basic	£100
C Basic -86	£217
C Basic Compiler	£334
C Basic Compiler -86*	£400
Pascal MT+	£235
Pascal MT+ 86	£395
<b>FOX &amp; GELLER</b>	
d Graph*	£170
d Util*	£65
Quickcode*	£170
<b>MICROPRO</b>	
Calcstar*	£95
Infostar*†	£338
Mailmerge*	£120
Wordstar*	£225
Wordstar Professional*	£450
Datastar*	£150
<b>MICROSOFT</b>	
Basic Compiler*	£250
Basic Interpreter*	£259
Fortran Compiler	£369
Multiplan*	£149
<b>PEACHTREE</b>	
Basic Accounting System	
per module	£300
Business Management Systems	
per module	£550
Peachpack*	£300
<b>SORCIM</b>	
Supercalc*	£105
Supercalc 2*	£165
Superwriter*	£255
<b>SAGESOFT</b>	
Sage Accounting*	£350
Sage Executive*	£670

Most popular machine formats are available.

#### HOW TO ORDER

Simply write to Oryx (stating machine format and disk size), or telephone 01-636 0476 to discuss your requirements. Or ring 01-631 4341 without obligation to reach our technical hotline. Callers at our London Office - just off Oxford Street - are very welcome. Orders will be acknowledged by return of post and goods will normally be despatched within 10 days. All products are supplied new and are sealed complete with manufacturer's documentation and factory warranties. All prices exclude VAT and are subject to change without notice.

FREE DELIVERY IN THE UK FOR ORDERS OVER £200.

All major credit cards are accepted.

Oryx Systems (U.K.) Limited, Mappin House, 4 Winsley Street, London W1N 7AR. Telex: 28290 ORYXUK G

### SOFTWARE FOR IBM/PC

Please see CP/M listing. All products with an \* will also run on MS-DOS and PC-DOS and are priced the same.

<b>BLTYHE</b>	
Omnis	£295
<b>DIGITAL RESEARCH</b>	
Concurrent CP/M-86	£225
CP/M-86 + GSX	£40
Pascal MT+	£265
<b>FOX &amp; GELLER</b>	
OZ: Management Control	£320
<b>IUS</b>	
Easy Writer I System	£175
Easy Writer II System	£275
<b>MICROSOFT</b>	
Fortran Compiler	£235
Flight Simulator	£45
Word	£269
<b>MICRORIM</b>	
R: Base 4000	£325
<b>LOTUS</b>	
Lotus 123	£340
<b>SPI</b>	
Open Access	£450
<b>SOFTWARE SYSTEMS</b>	
Multimate	£325
<b>SORCIM</b>	
Supercalc 3	£265

### BOARDS FOR IBM/PC

<b>AST RESEARCH</b>	
Mega Plus 64K	£275
Six Pack Plus 64K	£275
64K Chip kit	£73
<b>MICROSOFT</b>	
64K RAM Card	£199
256K RAM Card	£315
Mouse	£130
<b>QUADRAM</b>	
Quadboard II 64K	£280
Quadlink	£495
<b>HERCULES</b>	
Graphic Card	£350

### MONITORS

(One year warranty)

KAGA RGB Vision-III 12"	£369
MICROVITEC CLUB 653 14"	£395
SANYO SCM 14" VHR	£425

### PRINTERS

(One year warranty)

BROTHER HR15	£445
BROTHER HR25	£750
CANON 1080A	£319
EPSON RX-80 FT	£262
EPSON FX-80	£379
JUKI 6100	£399
MT 80	£225
MT 160	£449



**TeleVideo**  
Business Computers

**AUTHORISED DEALER**

All products subject to availability. CP/M is a registered trademark of Digital Research, IBM is the registered trademark of International Business Machines.

We cannot list all the products we carry - please call 01-636 0476 for further details.

ORYX - U.S. LEADERS IN TECHNOLOGY - NOW IN THE U.K.



• Circle No. 184

# DISKING means business

SEE US ON STANDS 526 AND 528 AT THE COMPUTER FAIR, EARLS COURT ON 14-17 JUNE FOR YOUR FREE GOODIES

## DISKING MEANS BUSINESS

\*FREE PEN for ALL Computer Users\*  
 or call (24hr answering) for our General Price List. Name this magazine and you will get your pen.  
 OUR business is here to serve YOUR business, and if you don't find us the slickest and most reliable UK disk supplier - we'll refund your monies in full. UK P&P is free, if we can't ship inside 4 working hours!

## FREE WITH EVERY TEN-PACK OF DISKETTES FROM DISKING

1. SEE 10 LIBRARY BOX  
 The Superb See 10 library box for storing and displaying ten diskettes. Available individually at £2 50 exc VAT, see under 'Diskette storage'



## PLUS 2. Disking 'COLOUR CODERS'

A multicoloured pack of ten fibre tipped pens for colour coding your diskette labels. Available individually at 49p exc VAT per pack of ten

## MEMOREX



### MEMORY EXCELLENCE

Memorex diskettes will work well in ANY computer - they have a reputation which is second to none

### 5 1/4" DISKETTES

Certified for single OR double density and with hub ring reinforcement

### PRICES EXC VAT

	10-40	50-90	100 -
3481 S S 48 tpi	21.90	20.90	19.90
3491 D S 48 tpi	27.90	26.90	25.90
3504 S S 96 tpi	27.90	26.90	25.90
3501 D S 96 tpi	35.90	34.90	33.90

48 tpi suitable for 35 or 40 track  
 96 tpi suitable for 77 or 80 track  
 10 & 16 Hard Sector at same prices

## 3 1/2" MICRODISKS

from

## MEMOREX

	10-40	50-90	100+
6100.....	39.90	38.90	37.90

Auto shutter 0.5MByte rating

## DISKING 'SHATTERING' OFFER



To prove just how good MEMOREX are, we at Disking are packing a FREE MEMOREX C-90 Cassette tape with every ten-pack of MEMOREX floppies until June 30th 1984. This offer does not affect any of our other promotions, and is in addition to them.

## maxell



### MAXELL - The Gold Standard

Maxell's newly packaged diskettes, consistently meet or exceed all standards. A quality to match the best.

### 5 1/4" DISKETTES

Certified for Single OR Double Density 48 tpi media with hub ring

### PRICES EXC VAT

	10-40	50-90	100+
MD1-D S S 48 tpi	24.90	23.90	22.90
MD2-D D S 48 tpi	32.90	31.90	30.90
MD1-DD S S 96 tpi	32.90	31.90	30.90
MD2-DD D S 96 tpi	42.90	41.90	40.90

48 tpi suitable for 35 or 40 track  
 96 tpi suitable for 77 or 80 track  
 10 & 16 Hard Sector at same prices

### 8" DISKETTES

### PRICES EXC VAT

	10-40	50-90	100+
FD1-128 S S S D.....	29.90	28.90	27.90
FD1-XD S S D D.....	34.90	33.90	32.90
FD2-XD D S D D.....	39.90	38.90	37.90

32 Hard Sector available at same price

## Dysan



Dysan Quality maintained - prices reduced

### DYSAN

With new lower prices Dysan's impeccable reputation is now a bargain. Go on, spoil yourself!

### 5 1/4" DISKETTES

Certified for Single OR Double Density, and all with Hub Ring reinforcement

### PRICES EXC VAT

	10-40	50-90	100+
104 1D S S 48 tpi	23.90	22.90	21.90
104 2D D S 48 tpi	34.90	33.90	32.90
204 1D S S 96 tpi	34.90	33.90	32.90
204 2D D S 96 tpi	42.90	41.90	40.90

48 tpi suitable for 35 or 40 track  
 96 tpi suitable for 77 or 80 track  
 10 & 16 Hard Sector at same prices

### 8" DISKETTES

### PRICES EXC VAT

	10-40	50-90	100+
3740 1 S S S D.....	29.90	28.90	27.90
3740 1D S S D D.....	32.90	31.90	30.90
3740 2D D S D D.....	40.90	39.90	38.90

32 Hard Sector available at same price

## DISKETTE ACCESSORIES

### 'PERFECT DATA' CLEANING KIT

In our experience the only cleaning kit that really works, and works reliably.

Part No:	Description	Price
CK5	For 5 1/4" Drives	14.90
CK8	For 8" Drives	14.90

### 5 1/4" DISKING SUPERMAILERS

Will mail up to 4 diskettes in their envelopes, and very rigid due to copyright design. Packed in 100's.

Part No:	Desc.	100	200	300
DSM	Mailers	24.90	22.90	19.90

## DISKETTE STORAGE

### Disking Swing Lid Box NEW Product! STORES 60 MINIDISKS

Keep your lid on with the new superior anti-static Disking lockable swing-lid box with convenient hinged smoked perspex lid dividers and two keys. Always keeps your disks in perfect condition and even has concealed carrying handles front and rear for your convenience.

RRP is 21 50. Our price exc. VAT is just

Part No:	Description	1-3	4
DSL8	60 Minidisk capacity	17.90	15.90

Packed individually and 4 to an outer carton



**How To Contact DISKING:**

By Telephone:

(0428) 722563

By Telex:

858623 Telbur G

By PRESTEL:

Page 2477310 - Please allow 5 days for the order to reach us.

By FAX:

(0252) 721521

**DISKING INTERNATIONAL**

FREEPOST

LIPHOOK

HAMPSHIRE

GU30 7BR

UNITED KINGDOM

**U.K. SHIPPING RATES INC. INS. BUT EXC. VAT**

**1/4" DISKETTES**

2 PACKS each pack @ 95p  
5 PACKS each pack @ 75p  
9 PACKS each pack @ 60p  
10+ PACKS \* POST FREE \*

**1/4" CLEANING KITS**

Same postal rate as packs of 5 1/4" diskettes. 10+ POST FREE

**8" DISKETTES**

1-2 PACKS each pack @ 1.60  
3-5 PACKS each pack @ 1.20  
6-9 PACKS each pack @ 90p  
10+ PACKS \* POST FREE \*

**8" CLEANING KITS**

Same postal rate as packs of 5 1/4" diskettes. 10+ POST FREE

**5 1/4" NEW 'SEE 10' LIBRARY BOXES**

SEE 10 5-9 off @ 30p  
SEE 10 1-4 off @ 40p  
SEE 10 10+ @ 20p

**8" LIBRARY BOXES**

LB8 1-4 off @ 60p  
LB8 5-9 off @ 45p  
LB8 10+ @ 30p

**DISKING SUPERMAILERS (5 1/4" only)**

100-PACK 3.00

**DISKING COLOUR CODERS**

10-Pack Multicolours 25p

**LOCKABLE DISKETTE STORAGE**

All versions: 1 off 2.00, 2-7 off 1.30 each, 8+ post free

**Verbatim®**



**Datalife - Five Year Warranty**

It's easy to see why they're the world market leaders. Perfect data retention everytime - for a lifetime - Datalife.

**1/4" DISKETTES**

certified for Single OR Double Density. and all with Hub Ring reinforcement

**PRICES EXC VAT**

	10-40	50-90	100+
ID525 S S 48 tpi	22.90	21.90	20.90
ID550 D S 48 tpi	29.90	28.90	27.90
ID577 S S 96 tpi	28.90	27.90	26.90
ID557 D S 96 tpi	36.90	35.90	34.90

8 tpi suitable for 35 or 40 track

6 tpi suitable for 77 or 80 track

0 & 16 Hard Sector at same prices

**8" DISKETTES**

**PRICES EXC VAT**

	10-40	50-90	100+
D34-9000 S S S Dens	31.90	30.90	29.90
D34-8000 S S D Dens	31.90	30.90	29.90
D34-4001 D S D Dens	36.90	35.90	34.90

2 Hard Sector available at same price

**NORMAL ORDERS - WE NOW WELCOME ALL OFFICIAL GOVERNMENT ORDERS**

We welcome orders from all Government Bodies including Schools Universities Colleges Hospitals the Utilities Research Establishments Armed Forces the Ministries and local Authorities etc We will despatch within 4 working hours from receipt of your official order number received either by post or over the telephone

Everyone else cheques with order please payable to DISKING If you are a large establishment and cannot raise cheques without an invoice please post or telephone us with your order and we will send a pro-forma invoice by return for your accounts department to pay against! Also bear in mind that you do have to pay VAT which will be added to these prices If you are in any doubt please telephone us for assistance

**CREDIT CARD ORDERS**

We welcome Access (Mastercharge) Barclaycard (VISA) & Diners Club International. & there is NO credit card surcharge You may write your C Card No on your order or telephone the order day or night 365 days a year You may speak for as long as you like (but please speak up and don't leave long gaps otherwise our machine thinks you've gone home) and don't forget to give the following details

- 1 Day time telephone number
- 2 Cardholder Name & Address
- 3 Delivery Invoice Address if different
- 4 Your Credit Card Number
- 5 Part Nos and quantity of what you wish to order
- 6 Normal First Class or Special Post

YOU MAY LEAVE THE REST TO US!

**URGENT ORDERS**

If you're posting your order. omit the word FREEPOST from our address, and use our normal postcode GU30 7EJ and do not forget to stamp it FIRST CLASS. If you are a Government body as defined under 'NORMAL ORDERS' and are telephoning your official order OR are an individual or company using your Credit Card No. please make it clear that you wish to pay for your goods to be sent to you by FIRST CLASS POST.

**FIRST CLASS RATES**

EXC VAT	5 1/4"	8"
First TEN-PACK	2.00	2.50
Second & subsequent TEN-PACK	1.50	2.00

**DESPERATE ORDERS U.K.**

Your options are:  
DA? APOST Next day U.K. - order by 3.00pm or:  
EXPRESSPOST Same day (ENGLAND) - order by 10.30am

Please telephone for further information.

PRICES SUBJECT TO EXCHANGE RATES & AVAILABILITY

**HARD DISKS FOR YOUR MICRO**



They come in four sizes, and there's one for YOUR machine:-

Part No:	5MB DS505	10MB DS510	15MB DS515	20MB DS520
APPLE II	1190.00	1290.00	1390.00	1490.00
IBM-PC	1290.00	1390.00	1490.00	1590.00
SIRIUS/VICT.	1190.00	1290.00	1390.00	1490.00
EPSON QX10	1190.00	1290.00	1390.00	1490.00
DEC LSI 11	1390.00	1490.00	1590.00	1690.00
Z80 System	1190.00	1290.00	1390.00	1490.00
S100 System	1290.00	1390.00	1490.00	1590.00

ONE slaves may be added at these lower prices

Slaves 990.00 1090.00 1190.00 1290.00

Complete with intelligent controller, host adaptor power supply unit, fan, cabling, software and User Manual. Free delivery in the UK.

**TRADE CORNER**

**\*\* FREE AEROPLANE \*\***

Being in the micro trade means you're dynamic and energetic but probably sit in front of your VDU too long like we do. So we've devised a way of getting you out into the fresh air - an aeroplane that flies. Just call and ask for your flier and of

course we'll send you our 1984 trade price list. We'll include your FREE sample unlabelled diskette and supermailer AND an application form for a DPC card to enable you to buy at our 10,000 prices yet order only in '50s.

**DISKETTE STORAGE**

**SEE 10 LIBRARY BOXES**

stores 10 Minidisks AND when open displays them all at the same time - Quite simply the best library box there is!

**PRICES EXC VAT**

Part No:	Description	1-49	50-
EE 10	Library Box	2.50	2.20
B8	Library Box	3.00	3.00

**LOCKABLE DISKETTE STORAGE**

These storage boxes come in four sizes, two for mini disks and two for 8" disks.

They hold 40 or 80 diskettes and come complete with keys and spindlers.

**PRICES EXC VAT**

Part No:	Description	Price
135	40 minidisk capacity	14.90
185	80 minidisk capacity	18.90
40	40 8" diskette capacity	18.90
80	80 8" diskette capacity	27.90

BARCLAYCARD

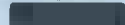

VISA

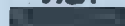

Access

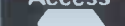

DINERS CLUB INTERNATIONAL

(0428) 722563

**£££ NO LIMIT VOUCHER**

Return this voucher with your next order and take £2.00 off ANY of these ten-pack prices.

Buy 2 ten-packs and save £4.00 and so on.

Conditions: (Please deduct the £2.00 before VAT : Offer ends July 31 1984 .

This voucher MUST accompany the order.)

Call Joan or Roger for Instant Response

● Circle No. 115

# G. W. COMPUTERS LTD

London's West End — Nationwide overnite service — More product ranges —  
Probably the widest selection of networks/micros/and printers

WE OFFER ONE OF THE BEST 'SYSTEM DEALS' IN THE U.K. (save 1500.00 +)  
THE NEW DBMS III.7 (series III of the world's first 'task-robot-programs')

G.W. COMPUTERS LTD — Tel: 01-631-4818

## .....FEATURES.....

<p>Mbasic &amp; word-star compatible 1400 character record sizes mathematical scratchpad, record relational indexes, translatable to any language User-definable reporting field protection/classification, either-or, same as, greater, smaller sorts alpha/numeric any window 12 online file architectures. 240 fields using cross-referencing cross-record calculations. 'Jump-to' any record in 12 files. User-define files/field words/sizes. "purchase/sales-analysis", "personnel-file"</p>	<p>32000 records per filename 20 main/200 sub fields per record. field and record related formulae. 'Jump-to' any of 3200 records per file. random/binary/key/multiple field search. 'if-then' questioning file protection/password entry, range match, not match, integer match, sort speed 500 records per 20 seconds endless 'either-or' matching formulate/recall on selection criteria. 13 interrogation question types short filing output/audit trails. "sale-mail-shots"; "production-process- "purchase/sales-analysis", "personnel-file"</p>
--	--

DBMS III 7 new switch mode facility enables you to cross up to 12 different files (32000 records per file) pre-selecting any of up to 20 fields per record/file for display/print output (240 fields) in all. One massive enquiry can pass through 384,000 records

You might have two files whose records are directly related to each other, so that the first file (say containing names and addresses) refers to the second file (say financial and other information relating to the same record numbers in the first file) directly. Then you can simply choose that in file 1 you are interested in just the name and telephone numbers, whereas in file two, you are interested in the income, trading period and number of branches, information. Your enquiry can then pass through both files highlighting that information only. Actually there doesn't need to be a strict correlation between the same record numbers in different files, and you can also just on JUMP command go to any record in any of the 32000 records in any one of the twelve files and carry on cross-referencing from there onwards

## DBMS'S MACROS WORK FROM THE MOMENT YOU INSERT THE 'TASK DISK' IN THE COMPUTER

Simply design your file, give its fields your words, set up your report mask, and then enter your records. Switch to 'automatic drive' and formulate any task you wish the program to fulfil, the task is stored as a macro. Take a copy of the program on another 'task disk' and from then on, the task disc will function without a single key-stroke. Think of a number of such 'task disks' such as "stock-re-order reports", "stock-valuation reports", analysis, "patient history analysis", "research-analysis", "budgeting", "plus more?"

Not only does this program surpass most of its kind that you might buy elsewhere, but if you buy the hardware from us, then you get it — FREE . . . . DBMS II (WITHOUT MACROS) AND DBMS III ARE FULLY IMPLEMENTED UNDER CPM-86 (tm) AND MS-DOS (tm) ie: < SIRIUS/VICTOR/IBM > DBMS II IS 395.00 (or 250.00 by mail order ex. training). DBMS II IS 575.00 (or 295.00 by mail order ex. training).

Contains the highest state of the art software available today

FORMS/TEXT/CALC/DBMS IV — ALL IN ONE PROGRAM THE —"KEY" — @ 575.00.

When you budget for a complete system of software you eventually end up with a host of packages like, Sales, Purchases, Nominal Data, Text, Calc, Mailshot, Invoice, Order, Workflow, Personnel, and so on. The list is endless and the outlay several thousands of pounds.

**Features** Design a form as wide as a window of 250 characters, long as needed. Cursor movements are 'left, right, up, down, delete left, delete right, tab right, left-up-down'. Paint your form as you like directly on the screen.  
**Text, Calc.** Write a letter as you see it on the screen, edit it then simply enter P to print. Set into the form, your data fields, "#####" and specific file-related activities, formulae and validation checks. Enter values and see the spreadsheet calculate itself.  
**Database.** Search files for data to be inserted to fields specified. All the features of DBMS III, explained elsewhere in our ad.

Here's an example of an invoice you might design for your stationery . . . . You could design your own spreadsheet, order form, statement, wage docket, or any other kind of form that is required to fit your existing stationery.

INVOICE					
To # <1> #####	From: G. W. Ltd				
# <2> #####	55 Bedford Court Mans.				
# <3> #####	Bedford Avenue				
# <4> #####	London W.C.1.				
# <5> #####	Tel: 01-636-8210				
Date <6> ###,##	Tax point <7> ###,##		Agent <8> ###		
Quantity	Description	Cost	Tax	Total	
<9> ###	<10> #####	<11> ###	<12> ###	<13> ###	
<14> ###	<15> #####	<16> ###	<17> ###	<18> ###	
Total . . . . <19> #####				Tax . . . . <20> #####	

<??> items <1> to <5> internal command to request name, input, and then search an address file for details.  
<??> items <6> to <7> request date input and validate.  
<??> item <8> request agent number and validate range.  
<??> item <9> request quantity, validate range.  
<??> item <10> request description, search file, accept, and calculate fields <11> <12> <13> if finished invoice then calculate fields <19> and <20>

Now comes the more valuable facility. You can provide the 'FORM' with file-related instructions, not only to request a 'console' input for file search against names, and stock, but after the invoice is finished, the fields you have selected may be passed to related files.

EG: Send fields <0>, <1>, <06>, <07>, <11>, <12>, <13>, <19>, <20>, to a sales ledger.  
Then send fields <9>, <10>, <11> to product analysis file.  
Then send fields <0>, <1>, <7>, <19>, <20> to V.A.T. file.  
Then send fields <10>, <11>, <12>, <13> to Nominal ledger. Do you see?

## POPULAR BRANDS OF EQUIPMENT WE SELL

**MICROS** —Sirius/Victor/I.B.M./Dec/Epson/North-star  
—Sanyo/Superbrain/CompuStar/Altos/Apple/Lisa  
—Televideo/Corona/Compaq/Eagle

**PRINTERS** —Nec/Qume/Diablo/Okii/Epson/Olympia/Ricoh  
—Texas/Dre/Anadex/Others

**OTHERS** —Corvus/CompuStar/Syquest  
—hand disks networks and multiplexors  
—Spoolers/Modems/Buffers  
—most of the best known brands of software

Syquest 5.6MS cartridge drives on I.B.M. PC.

Remember! the software is the 'key' & the hardware less important.

## TERMS & ETC

G.W. Computers Ltd (Grama (Winter) Ltd)  
43/55 Bedford Court Mansions  
Bedford Avenue  
London: W.C.1 England  
Telex 892031 TWC G

Telephones:  
01-636-8210  
01-631-4818  
Boston office tx 94-0890

24 hour answerphones; leave address for 'intopacks'. We do not operate a reader's reply card service. Terms: C.W.O. or C.O.D. Prices exclude V.A.T., but include all non-credit discounts available. No dealers! The above lists are not exhaustive. Please call at our showroom only by prior appointment. Unless expressly agreed, all warranties are commercial 90 days return to base for parts and labour. Annual warranties and maintenance facilities available nationwide through closely related third parties.

## The new BUSINESS SYSTEM DEAL only from G.W. Ltd

**\*\*COMPUTER\*\*TAVA PC features\*\*\*\***  
IBM(tm) compatible system with:  
128k ram  
2" double sided h/height 360k floppies  
2" 5.6mb hard disk same enclosure  
2" serial interfaces  
1" parallel interface  
1" pc-compatible keyboard  
1" monitor & adapter 2995.00

**\*\*PRINTER\*\* EPSON FX80** 435.00  
Cables/setup and testing 85.00  
50 diskettes 150.00  
Box listing paper 15.00  
Dos 2.00 60.00  
Various books/manuals 25.00

**\*\*SOFTWARE\*\***  
DBMS 111.7 575.00  
The KEY relational databases/text formatter/calc 975.00  
Word-plus 195.00  
Super-calc 195.00  
Games/utilities/communications 125.00  
5830.00

OUR PRICE \*\*\*\* 3695.00 plus v.a.t. \*\*\*\*

Please note that the COMPUTER and PRINTER is transferrable to any other model that we stock, EG: IBM/TXAS/CORONA/SIRIUS/ETC Also: delivery & training extra

# Spectrum legion

Bill Bennett wades through the plethora of books covering Sinclair's book-sized micro and selects some of those worth reading.

SO MUCH FOR the paperless society. As computers find their way into more and more homes so do computer books. Their numbers are legion: my sagging bookshelf currently holds over 25 titles covering the Spectrum alone. At this rate it will not be acid rain that poses the biggest threat to the forests of British Columbia, but Sinclair's book-sized micro and its attendant literature.

Before the explosion in home-computer use, micro books were published by tiny companies. They were high on raw information, but awfully difficult for the person on the Clapham omnibus to read on their way home. Now a number of the larger publishing empires have got in on the act, offering contracts that would make even Harold Robbins's well-paid eyes bulge.

They do not come much bigger than Penguin, so you would expect the giant publisher's efforts in the micro sphere to be impressive. *Getting the Most From Your Sinclair Spectrum* by Anne Sparrowhawk is anything but. If it is typical of the Penguin Personal Computer Collection, then Penguin may be in for a rude shock.

It is not a bad little book in itself, but Anne Sparrowhawk has not actually added anything to the fund of human knowledge. In fact the majority of information to be found in this £4.95 lightweight can be found in a much easier to digest form in the manual that comes free with the micro. What is more the manual has better cover artwork.

As you would expect, the Penguin book is nicely put together but I cannot see why anyone would want to part with just under a fiver for it. Still, there is a classic chapter called "The World of Software", and it was while poring over this that I came across the amazing revelation that there is some software available for the Spectrum. Well I never!

Not to be outdone, Pan Books has a whole range of titles produced in conjunction with another micro magazine. *Instant Arcade Games for the Sinclair ZX Spectrum* by Jean Frost might not be the snappiest of titles, but the book is an excellent collection of programs to type into your Spectrum.



Strangely enough for one supposedly devoted to arcade games, Jean Frost's book turns out to be very good when describing how to write adventure games. As an adventure-loathing arcade addict, I am glad I didn't have to part with a hard-earned £3.95 for the book. However, it is excellent value if your idea of fun is entering listings.

In a similar vein is *Sixty Programs for the Sinclair ZX Spectrum*, by a whole bunch of distinguished names. There is nothing to the book but programs, programs and more programs. I have to confess that I would rather fork out the money for a cassette than enter programs, but doing so is an excellent way of learning more about your computer.

Fontana is yet another publisher to cash in on the micro boom. Like the other major book companies, Fontana's contribution to the computer world is that it has managed to publish books of a similar quality to the established competition but at a much lower price. But after looking at over 25 Spectrum books, I can report that there is no correlation between a book's price and its worth.

*Better Programming for your Spectrum and ZX81* by S Robert Speel costs only £2.95, yet it contains over 40 programs. The programs are jolly good, certainly higher than average in the other books reviewed here. It is aimed at those who might not yet be able to run, but are certainly able to walk fairly briskly as far as Basic programming is concerned.

On the negative side, it is deceptive to

lump the Spectrum and ZX-81 together in the same book. They are totally different animals. It is almost like selling a book about lion taming and house training your cat. Most of the programs are centred around the character-definition facilities of the Spectrum.

However, the book is a source of fresh ideas, a veritable treasure-trove including some useful programs and games. I liked the Gothic nature of the games, which include an adventure, a three-dimensional maze and an arcade-style medieval joust.

Also from Fontana is *The Good Software Guide*. Egon Ronay should sue since, unlike the good food guides, this potentially useful paperback lacks any real criticism. I realise that the authors only wish to point out the good software, but a true good software guide would be a lot thinner. What is more, the book is out of date, and would have been within weeks of being published. If you would like to know which Spectrum programs are worth buying go and ask someone else.

In fact a large percentage of the books available cannot justify their existence. All too often the same old material is printed again and again in different guises. The amount of duplication among the books is amazing.

For instance there are two, possibly more, books dealing with the Sinclair Microdrives. One from Sunshine, and the other from Melbourne House. The second book, by Dr Ian Logan, is packed full of useful information and is a great

(continued on next page)

(continued from previous page)

improvement on his earlier books, although I do feel uneasy when I see typeset program listings because they are liable to cause all sorts of errors. Despite that misgiving, it's thumbs up for Ian Logan. At £5.95 he has provided an intelligent add-on to the Microdrive manual.

On first impressions, the Sunshine book, by Andrew Pennell is much the same. So what could justify the extra £1 over its rival? About 25 percent more pages is the easy answer — never mind the quality feel the width. To be fair it is a useful adjunct to the official manual. It is much more use if you are not a machine-code programmer, while Logan's book is for the more dedicated Microdrive hacker.

Unfortunately the other Melbourne House book in this survey cannot be recommended. *Super Charge Your Spectrum* by David Webb is yet another good idea which has been thrown away. The theory behind the book is that it will "extend your Spectrum with ready-made machine-code routines". Just what the doctor ordered.

Opening the cover I was confronted with a list of corrections to the rest of the book, which filled two pages. Worse still, I managed to find a number of other errors. While this may not be good, especially in a book that costs £5.95, the book still might have been worth buying if it was not for the rather heavy warning that you are not actually allowed to use the routines in the book as they are copyrighted. If that is the case then pages 177 to 182 are the most useful in the book — they are blank with the word "Notes" printed on them.

A book which should particularly appeal to *Practical Computing* readers is *Advanced Graphics with the Sinclair ZX Spectrum* by I O Angell and B J Jones. It is not cheap at £9.95, but is worth its weight in silicon. Although it does make the inevitable excursion into games graphics, it also includes some sophisticated techniques for all sorts of graphics. And to please the analytically minded there is a section on diagrams and data graphs.

*Programming Arcade Games for your Spectrum* by Adrian Jones is just the kind of book to buy a youngster for a birthday or Christmas present. Well laid out, logically thought out and packed with games and ideas this book is definitely one for the younger user. Well worth the £4.75.

*Drive your Spectrum* is a sister publication to the games book and both hail from the Foulsham presses. It has some pleasing colour photos and costs a bit more at £5.95. Its main claim to fame is the word-processor program included within. It is not as good as its companion.

*Machine-code Applications* by David Laine is a rare bird indeed, a book about machine code written by a literary adept. This is similar in concept to the Melbourne House "Super Charge" book, but without the masses of errors and there is no dire warning about the copyright of the little

*Advanced Graphics with the Sinclair ZX Spectrum* by I O Angell and B J Jones. Published by Macmillan Press, £9.95. ISBN 0 33 35050 2

*Spectrum Graphics and Sound* by Steve Money. Published by Granada Publishers, £6.95. ISBN 0 246 12192 0

*Assembly Language for Arcade Games and other Fast Spectrum Programs* by Stuart Nicholls. Published by McGraw-Hill, £7.95. ISBN 07 084729 0

*Spectrum Magic* by Steve Betts. Published by Foulsham, £5.50. ISBN 0 572 01233 0

*Machine-code Applications* by David Laine. Published by Sunshine, £6.95. ISBN 0 946408 173

*Very Basic Basic* by Derek Ellershaw and Peter Schofield. Published by Century, £2.95. ISBN 0 7126 0410 3

*Getting Started on your Spectrum* by Tim Hartnell. Published by Futura Books, £2.95. ISBN 0 7088 2442 0

*Spectrum Micro Drive Book* by Ian Logan. Published by Melbourne House, £5.95. ISBN 0 86161 127 6

*Master Your ZX Microdrive* by Andrew Pennell. Published by Sunshine Books, £6.95. ISBN 0 946408 19 X

*Better Programming for your Spectrum and ZX81* by S Robert Speel. Published by Fontana Paperbacks, £2.95. ISBN 0 00 636610 4

*Super Charge Your Spectrum* by David Webb. Published by Melbourne House, £5.95. ISBN 0 86161 112 8

*Spectacular Games for Your ZX Spectrum* by Hal Renko and Sam Edwards. Published by Addison Wesley, £3.95. ISBN 0 201 14667 3

*Introducing Z-80 Assembly Language Programming* by Ian Sinclair. Published by Newnes Microcomputer Books, £6.50. ISBN 0 408 01338 9

*The Spectrum Pocket Book* by Trevor Toms. Published by Phipps Associates. ISBN 0 950 730 289

*Instant Spectrum Programming* by Tim Hartnell. Published by Interface, £4.95. ISBN 0 907563 22 8

*Learning to Use the ZX Spectrum* by Robin Bradbeer. Published by Gower, £4.95. ISBN 0 566 03481 6

*Delving Deeper into Your ZX Spectrum* by Dilwyn Jones. Published by Interface, £7.95. ISBN 0 907563 24 4

*The Sinclair Spectrum in Focus* by Mark Harrison. Published by Sigma Technical Press, £6.25. ISBN 0 905104 28 5

*Sixty Programs for the Sinclair ZX Spectrum* by R Erskine, et al. Published by Pan, £4.95. ISBN 0 330 28260 3

*15 Graphic Games for The Spectrum* by Richard Hurley. Published by Micro Press, £5.95. ISBN 0 7447 0002 7

*Instant Arcade Games for the Sinclair ZX Spectrum* by Jean Frost. Published by Pan, £3.95. ISBN 0 330 28265 4

*30 Hour Basic* by Clive Prigmore. Published by BBC, £5.95. ISBN 0 86082 394 6

*Getting the Most From Your Sinclair Spectrum* by Anne Sparrowhawk. Published by Penguin, £4.95. ISBN 0 14 00 7802 9

*Drive your Spectrum* by Anthony Camacho. Published by Foulsham, £5.95. ISBN 0 572 01211 X

*Programming Arcade Games for your Spectrum* by Adrian Jones. Published by Foulsham, £4.75. ISBN 0 572 01235 7

*The Good Software Guide* by Roger Bilboul, John Durrant and Matthew Spencer. Published by Fontana Paperbacks, £3.85. ISBN 0 00 636772 0

programs. The diagrams look a bit of a mess, but otherwise I have no reservations about recommending this book. Machine code is not for beginners, and neither is this, but any book that manages to quote from Francis Bacon and Lewis Carroll cannot be entirely bad.

Finally, for £2.95 you could do a lot worse than buy *Very Basic Basic* by Derek Ellershaw and Peter Schofield. This well designed beginners' guide should put even the most recalcitrant computer naif on the right track. Definitely one for the younger reader.

TOP VALUE from **NEC...**



2.4Mb!

the **ADVANCED Personal Computer (APC)** from  
only **£1,735 + vat**  
including free NEC dot printer or software package

### STANDARD FEATURES

- **SPEED:** full 5 MHz 8086 16 bit processor (true 16 bit data).
- **CAPACITY:** One or two ONE MEGABYTE 8" disks (1.2 Mb each under MSDOS)
- **MEMORY:** 129k user RAM + screen RAM + system ROM + battery-backed CMOS non-volatile RAM & clock/calendar.
- **OPERATING SYSTEMS:** MSDOS or CPM-86 or CONCURRENT DOS (CPM).
- **HIGH RESOLUTION:** 8 x 19 dot character screen definition, (25 lines of 80 characters + 26th system status line), 12 inch green screen.
- **AWARD WINNING NEC 7220** graphic chip in character mode. 256 standard character set includes maths/greek & graphic symbols. ADDITIONAL 256 USER-PROGRAMMABLE shape character set(s).
- **DETACHABLE KEYBOARD:** Fast buffered 61 key + 25 key numeric/cursor pad + 22 dual mode function keys with labelling facility (16 of which will each hold two 15 character user-defined strings).
- **SERIAL RS-232:** Up to 19,200 baud synch/asynch. PARALLEL printer.
- **SUPERB MANUALS:** operating level to full technical spec (US written).
- **COMPACTNESS:** 19 inches wide, 24 inches deep, 14 inches high.
- **PRICE:** unbelievable for the quality of this product from the mini-computer division of NEC (world's 3rd largest micro manufacturer).

### OPTIONAL EXTRA FEATURES

- **EXPANDABLE USER MEMORY:** in 128k units to 6540k RAM.
- **HARD DISKS:** one/two (10-20 MB formatted), floppies ideal for backup.
- **8 COLOUR SCREEN:** (standard software uses colour optionally).
- **VERY HIGH RESOLUTION GRAPHICS:** 640 x 475 x 8 colour screen from 1024 x 1024 x 3 bit mapped array (384k extra RAM!). Hardware draw, pan & zoom using 2nd NEC 7220 controller. Fast! Macro shape generation etc.
- **32 BIT HARDWARE ARITHMETIC PROCESSOR:** 8087.
- **CONCURRENT CPM NOW AVAILABLE.**
- **8 BIT Z80 CARD NOW AVAILABLE** for dual standard 8 & 16 bit.

### SOFTWARE

CUSTOMISED software packages to your requirements for less than the price of a typical inflexible standard package — details on request.  
**ACCOUNTS:** Own bespoke packages at two levels, SYSTEMATICS, PEACHTREE.  
**WORD PROCESSING:** NEC Benchmark, Spellbinder, Wordstar, etc.  
**DATABASE:** DBASE II, Rescue, Datastar, Friday! etc.  
**LANGUAGES:** C, CB-86, CBASIC-86, Microsoft BASIC, COBOL, FORTRAN, PASCAL, PL1.  
**COMMUNICATIONS:** Asynch, IBM: Bsync 3780, 3270, HASP.

# Brighton Computer Centre

130 Lewes Road, Brighton BN2 3LG  
(0273) 673114 Mon-Sat 10am-6pm

Please send me further details of the NEC APC.

Name .....

Company .....

Address .....

..... Tel.....

Application ..... PC/1/84

# THIS MONTH'S AURORA PACKAGE

## STOCKFLOW

### STOCK CONTROL SYSTEM

This package is readily understood by a busy storeman, whilst providing management with comprehensive reports to answer their most sophisticated requirements. May be used "Stand Alone" or as part of an integrated business control system. Runs on any CP/M or CP/M-86 based computer and is suitable for organisations ranging from one man businesses to giants like British Telecom.

FOR FURTHER DETAILS, COMPLETE THE COUPON AND SEND TO:  
**GREAT NORTHERN COMPUTER SERVICES LTD,**  
 16 TOWN STREET, HORSFORTH, LEEDS LS18 4RJ  
 TEL: (0532) 589780.

NAME .....

ADDRESS .....

.....

.....

PLEASE SEND ME DETAILS OF:

STOCKFLOW  OTHER AURORA PACKAGES.

# As well as giving a superb service, we will still better any genuine discounts that you are offered Ring 01-206 0440.....Now !!

COMMODORE 64		RECOMMENDED PRICE
Commodore 64	64K Ram 40 Col	199.13
SX-64 Portable	64K Ram +Disk & Monitor	778.26 *
CBM 1541	Single Disk Drive 170K	199.13 **
CBM 1701	Colour Monitor	200.00
CBM 1520	Printer Plotter	147.81
CBM MPS-801	50 CPS Matrix Printer	200.00
CBM 1526	60 CPS Letter Qual. Matrix	300.00

COMMODORE BUSINESS MACHINES		
CBM 4032	40 Col 32K Ram	495.00
CBM 8032	80 Col 32K Ram	675.00
CBM 8096	80 Col 96K Ram	795.00
CBM 710	80 Col 128K Ram	995.00
CBM 715	80 Col 256K Ram	1195.00

COMMODORE DISK DRIVES		
CBM 2031	Single Drive 170K	295.00
CBM 1001	Single Drive 1Mb (8250 Disk)	495.00
CBM 4040	Dual Drive 170K per Drive	N/A USE 2031
CBM 8050	Dual Drive 500K per Drive	895.00
CBM 8250	Dual Drive 1Mb per Drive	895.00

COMMODORE PRINTERS		
CBM 4023	Matrix 80 Col 60 cps	345.00
CBM 8023	Matrix 132/256 Col 160 cps	625.00
CBM 6400	Daisy Wheel 132 Col 45cps	995.00

ROMS & CHIPSWITCHES		
Chipswitch: Basic 2+4 together (excl. ROMs)		57.50
RAM/ROMS (4 K/b Ram in Rom....1)		39.09
Audible disk error warning		13.00
Rom expansion (2 roms in 1 socket!)		25.00
Upgrade ROMs: Basic 1 to 2 or 2&3 to 4		50.00

SIRIUS/VICTOR		RECOMMENDED PRICE
Double Sided 128K (2.4Mb)		2695.00
Double Sided 256K (2.4Mb)		2895.00
Integral Mini 256K (10Mb +1.2Mb Floppy)		3995.00
Memory Expansion Boards		

OTHER PRINTERS		
CP80	Matrix 80 col 50 cps	199.00
FX-80	Matrix 80/132 col 80cps	438.00
FX-100	Matrix 132/256 col 160cps	569.00
DP1515	Matrix 132/256 col 130cps	219.00
GP700A	Matrix 80 Col 35 cps 4 Colour	495.00
MCP-40	Printer Plotter 4 colour	113.00
Juki 6100	Daisy Wheel 132 Col 20cps	399.00

Miscellaneous		
Dust Covers (All Machines)		4.00
Cable PET to IEEE (2 Metre)		30.00
Cable IEEE to IEEE (2 Metre Stackable)		35.00
Cable IEEE to IEEE (2 Metre Non Stack)		17.50
Cassettes (C12) with Case (10)		4.80
CENTRONIC, IEEE, RS232 CONNECTIONS from		1.00

Computer Stationery		
Paper (1 to 4 prt all sizes)		
Labels (1 across to 4 various sizes)		
Forms (Standard & to order)		

Ribbons & Disks		
Ribbons (CBM QUME DIABLO etc)		
Disks (Various Brands all types)		
Disk Cleaning Kits & refills		
Dais, Wheels (Qume Diablo etc)		

## commodore COMPUTER

\* THE NEW SX-64 PORTABLE COMES WITH £225.00 WORTH OF SOFTWARE FREE!!!  
EASY SCRIPT, FUTURE FINANCE, EASY STOCK

\*\* COMMODORE 1541 DISK DRIVE FOR THE COMMODORE 64 COMES COMPLETE WITH EASY SCRIPT!!  
30th APRIL 1984 OR UNTIL STOCKS ARE EXHAUSTED.

### SOFTWARE PRICE LIST

Accounting Systems & Financial Planning		
Anagram Integrated Accounting Systems		
IAS/1 CBM 8032 Only	999.00	
IAS/2 CBM 8096/700 with Product File	999.00	
IAS/3 CBM 8096/700 with Stock Control	1299.00	
Multi User price per additional terminal.	100.00	
Visicalc (3032/4032/8032)	125.00	
Visicalc (8096)	195.00	
Financial Director	250.00	
Superpay	400.00	
Database Management		
DMS 8000	195.00	
DMS Diamond	395.00	
Administrator	495.00	
Silicon Office (CBM 8096 ONLY)	790.00	
Superbase (CBM 8096 & 700)	400.00	

Word Processing Systems		
Wordcraft (4032/8032/8096/Sirius)	400.00	
Wordpro (4032/8032/8096)	395.00	
Microscript (8032/8096)	425.00	
Superscript (3032/4032/8032/8096)	250.00	
Superspell for Superscript & Wordpro	150.00	
Superscript & Superspell combined.	380.00	
Superscript II (CBM 700)	400.00	

Small Business Programs		
Cashbook	from £50.00 to £120.00	
Stock Control 3000 item	60.00	
Bar Stock Records	295.00	

**CP/M & MSDOS**  
We carry a large & comprehensive stock of  
CP/M & MSDOS software for Sirius Systems.

ALL PRICES EXCLUDE VAT



## L & J COMPUTERS

192 HONEYPOT LANE, QUEENSBURY, STANMORE, MIDDX HA7 1EE. 01-204 7525



PERSONAL SHOPPERS WELCOME  
Phone & Mail Orders accepted.

ALL GOODS SENT SAME DAY WHEREVER  
POSSIBLE LARGE S.A.E. FOR LISTS ETC.



• Circle No. 244



# Superbase 64

TRANSFORMS THE COMMODORE 64 INTO A FULL-FEATURED AND PROFESSIONAL DATABASE SYSTEM! WITH UP TO 1000 CHARACTERS PER RECORD ON UP TO 4 SCREENS... AND UP TO 128 ITEMS PER RECORD, DEFINABLE AS KEY, TEXT,

NUMERIC, CONSTANT, RESULT OR DATE... IN FILES OF UP TO 164 CHARACTERS! SUPERBASE 64 EVEN HAS SPREADSHEET AND CALCULATOR CAPABILITY, CALENDAR FUNCTIONS, EASY INPUT FROM WORDPROCESSOR/DATA FILES, BOTH MENU-DRIVEN AND PROGRAM OPTIONS, SORTING/SEARCHING, FULLY DEFINABLE OUTPUTS... SUPERBASE 64 IS ESSENTIAL IF YOU WANT THE MOST FROM YOUR 64! SUPPLIED ON CBM 1541 DISK WITH EXCELLENT TUTORIAL/REFERENCE MANUAL. ~~OUR PRICE £99.95~~ £88.00!

## VIZAWRITE 64

VIZAWRITE 64 IS A HIGH-PERFORMANCE, LOW-COST WORD PROCESSOR, WITH ON-SCREEN FORMATTING, THAT TAKES FULL

ADVANTAGE OF THE 64'S COLOUR, GRAPHICS AND MEMORY FEATURES... AND SUPPORTS VIRTUALLY ANY PRINTER! WITH A COMPREHENSIVE AND EASY-TO-FOLLOW USER MANUAL, VIZAWRITE IS THE ULTIMATE PERSONAL COMPUTER WORD PROCESSOR! AVAILABLE ON CARTRIDGE (~~£89.95~~ £75!), DISK (~~£79.95~~ £68!) OR WITH VIZASPELL (~~£99.95~~ £85!)

## Master 64

MASTER 64 IS A TOTALLY NEW CONCEPT... A COMPLETE PROGRAM DEVELOPMENT PACKAGE, THAT'S AVAILABLE NOW FOR THE CBM 64.

MASTER HAS 85 NEW COMMANDS... AND BASIC IV TOO! PLUS PROGRAMMER'S TOOLKIT, MACHINE CODE MONITOR, BUSINESS BASIC, KEYED DISK ACCESS, MULTIPLE SCREENS, USER-DEFINABLE INPUT ZONES, REPORT GENERATOR, 22-PLACE ARITHMETIC, DISK DATA COMPRESSION, DATE CONTROL, SCREEN PLOT, SCREEN DUMP, AND MORE... EVERYTHING YOU NEED TO PROGRAM YOUR 64 TO TOP PROFESSIONAL STANDARDS! (~~£149.95~~ £115!)

\*\*\* WANT IT TOMORROW? \*\*\* CALL US TODAY! \*\*\* ON 01-546-7256

VIZASPELL (DISK) .....	£59.95	£49.95	DTL COMPILER 64 (DISK) ..	£114.95	£109.00
EASYRIP (DISK) .....	£75.00	£69.00	SUPERBASE (CBM 700) .....	£112.50	£425.00
EASYSPELL (DISK) .....	£50.00	£48.00	SUPERSCRIPT (CBM 700) .....	£112.50	£425.00
SIMON'S BASIC (CARTRIDGE) ..	£50.00	£48.00	SUPEROFFICE (8096/8296) ..	£150.00	£650.00
ASSEMBLER 64 (DISK) .....	£24.99	£23.00	SUPERBASE (8096/8296) ..	£150.00	£375.00
TOOL 64 (CARTRIDGE) .....	£49.99	£46.95	SUPERSCRIPT (8096/8296) ..	£150.00	£375.00
PRACTICALC (DISK/TAPE) .....	£44.95	£41.50	SUPERSCRIPT (3000-8000) ..	£124.95	£225.00
MULTIPLAN (DISK) .....	£79.95	£75.00	MASTER (4000-8296) .....	£150.00	£225.00

PRICES INCLUDE 15% VAT AND ARE CORRECT ON GOING TO PRESS. ORDER BY POST OR PHONE, USING CHEQUE, ACCESS/BARCLAY CARD OR OFFICIAL ORDER. DESPATCH IS BY SAME-DAY 1ST CLASS POST, PREPAID ORDERS FREE. PRODUCT DATA AVAILABLE ON REQUEST. REF A28



# Calco Software

LAKESIDE HOUSE, KINGSTON HILL, SURREY, KT2 7QT. TEL 01-546-7256

• Circle No. 185

## MAIL ORDER PROTECTION SCHEME

If you order goods from Mail Order advertisements in this magazine and pay by post in advance of delivery, Practical Computing will consider you for compensation if the Advertiser should become insolvent or bankrupt, provided that:

- (1) You have not received the goods or had your money returned; and
- (2) You write to the Publisher of (name of magazine) summarising the situation not earlier than 28 days from the day you sent your order and not later than two months from that day.

Please do not wait until the last moment to inform us. When you write, we will tell you how to make your claims and what evidence of payment is required.

We guarantee to meet claims from readers made in accordance with the above procedure as soon as possible after the Advertiser has been declared bankrupt or insolvent.

This guarantee covers only advance payment sent in direct response to an advertisement in this magazine not, for example, payment made in response to catalogues etc., received as a result of answering such advertisements. Classified advertisements are excluded.

## >NEXT MONTH

### >INTERESTING INPUTS

Mice have awakened people to the fact that a keyboard is not the only way to talk to a microcomputer. In the August issue special section we look at some of the options such as voice input and touch screens, to see how far they represent a practical alternative.

### >REVIEWS

Triple test — IBM look-alikes from three countries are put through their paces: the Taiwanese-designed Aviette PC-16, the American-designed ITT Xtra, and the British PCi from Future Technologies. Plus reviews of the new Tandy Model 2000, Dragon software running under OS-9, more about Open Access and Atari games.

## >AND MUCH MORE!

Now for 3-D on the BBC! This remarkable feat is promised for next month, though you do have to don the dreaded red and green spectacles. Plus structured programming on a Commodore 64 — possible with the machine-code Commentator program, see the full listing next month. Meanwhile Chris Naylor brings a whole new meaning to clean machine as he dons his rubber gloves to scrub down the old motherboard. There will also be the usual full range of features to keep you in touch with what's happening in the wide world of microcomputers. News, reviews, free software in Open File, and much, much more.

Make sure you don't miss the August issue of

# Practical Computing

On sale at W H Smith and all good newsagents after 11 July

Contents may vary due to circumstances beyond our control and are subject to change without notice.

# PREPARE TO MEET YOUR MARKET

**A**t the Northern Computer Fair you can be certain of meeting your market. Thousands of visitors will be drawn to the show by the extensive promotional activity planned prior to the exhibition.

You could be there to meet them when the doors of the show open on November 22, 1984 – just in time for the pre-Christmas spending spree.

And the exhibition is also a cost-effective way of making important trade contacts in the lucrative northern market.

So prepare to meet your market now by returning the coupon for further details – or call Chris O’Hea on 01-661 3125 right away.

## THE Northern Computer Fair

*Personal computers  
Home computing  
Small business systems*

Belle Vue, Manchester. November 22-24 1984.

Sponsored by:  
Practical Computing,  
Your Computer,  
Micro Business.

Please send me further information on exhibiting at the Northern Computer Fair.

Name \_\_\_\_\_  
Position \_\_\_\_\_  
Company \_\_\_\_\_  
Address \_\_\_\_\_  
Telephone No. \_\_\_\_\_

Return to: The Exhibition Sales Manager,  
The Northern Computer Fair, Room L310,  
Quadrant House, The Quadrant House, Sutton,  
Surrey SM2 5AS.

# MS 21/23

**LOW COST COMPACT MODEM  
CAPABLE OF BOTH V21 AND V23 OPERATION**



The MS 21/23 will access computers, terminals and various data bases such as Prestel, Miconet 800, etc., as well as electronic mail services from Telecom Gold. Link is by cable from an RS232 outlet.

- Fully BT APPROVED
- User selectable modes of operation:
  - V21 (0-300bps) answer/originate
  - V23 (0-1200bps) half duplex
  - V23 (75/1200bps) duplex
  - V23 (1200/75bps) duplex
- Bell 103 and 202 frequency
- Automatic Disconnection
- 620 Cable Connection to BT Jack Plug Supplied
- Self Test. Analogue loop in each operational mode
- CCITT V25 answer sequence

**£199**  
INC. VAT

*For further information cut out or call  
Dept. P.C., Master Systems.*

**0276-685385**

**DEALER ENQUIRIES  
WELCOME!**

Please supply the name and address of my nearest MS21/23 dealer

Name \_\_\_\_\_

Address \_\_\_\_\_

Tel No \_\_\_\_\_

**MASTER SYSTEMS  
(Data Products) LTD**

100 Park Street, Camberley, Surrey

PC7/84

● Circle No. 252

If you want it tomorrow . . .  
call us today  
01-455 9823

**COMPUTERS/CALCULATORS/PLOTTERS**

<b>HEWLETT PACKARD</b>		CE 159 8K Add on mem with BATE	£79.00
HP 4 1CV (SCI Comp/Cal)	£176.00	CE 152 Cassette	£36.00
HP 4 1CX (Computer)	£220.00	MZ-711 Computer	£199.00
HP 4 1C (Card Reader)	£129.95	MZ-711 Printer Plotter	£110.00
HP 4 1C Printer B2 143A	£230.00	MZ-8080AEU Exp Unit	£86.00
HP 4 1C Printer B2 162A	£300.00	PC 1251 (Computer)	£69.00
HP 4 1C Cassette drive	£290.00	New HP 150 personal office computer terminal unit or upgradable with disc drives to 14.7M bytes £2300.00	
HP 16C (Hex Con)	£84.00	Epson QX-10 (desk top comp)	£1700.00
HP 15C (Adv Sci)	£84.00	EPSON HX20 Briefcase computer. 16K expandable. Serial and RS232 interface.	£375
HP 71C (portable computer)	£410.00	EPSON PX-8 (portable 64K Computer/Word Processor)	£775.00
HP Plotter 7470A RS232 or HP1B	£799.00	EPSON DX 100 (new low cost daisywheel) (BCPS-5K buffer)	£399.00
<b>SHARP</b>			
PC 1500 Pocket Computer	£130.00		
CE 158 RS232 and Cent I F	£130.00		
CE 150 printer cassette I F	£130.00		

**WORD PROCESSING PRINTERS/MONITORS**

<b>NEC 2000</b>		<b>BROTHER* "Highly Recommended"</b>	
(RS232 or Centronics)	£650.00	HR1	£598.00
7710 RS232/7730 Centronics	£1650.00	Serial or Centronics -	
<b>SILVER REED</b>		HR15 (3K Buffer 18 CPS)	£399.00
EXP 500 (12CPS)	£299.00	HR25 (3K Buffer 25 CPS)	£715.00
EXP 770 (31CPS-2K Buffer)	£850.00	<b>DIABLO 630*</b>	
Low cost daisywheel	£375.00	620(RO)	£650.00
<b>QUME</b>		630(ECS)	£1850.00
9/45 RO-FFP	£1650.00	630(API) (IBM COM)	£1400.00
9/55 RO-FFP	£1999.00	630(KSR)	£1136.00
11/40 RO (Also IBM-PC)	£1225.00	Tractor (B...)	
<b>TEC STARWRITER*</b>		FU... HEEL	
F10-55 CPS (serial/parallel)	£13...	<b>RUTISHAUSER</b>	
Tractor (Bi-Di)		Sheet Feeders and Tractors for: Qume, Diablo, NEC, Ricoh, TEC Starwriter, Olivetti, etc. From £99.00	
Sheet Feeder		<b>RICOH*</b>	
Mechanical Sheet F...		Model RP 1300 (S) (4K Buffer)	£990.00
<b>OLYMPIA*</b>		Flowriter (8K) PR 1600	£1450.00
ESW 103	£899.00	IBM-PC Version	£1500.00
<b>TOSHIBA</b>		Mechanical Sheet Feeder	£475.00
The all... need - Word Processing/draft/Data Processing printer using a - 24 wire printhead to give exceptionally high letter quality output		Tractor Feed	£175.00
<b>COLOUR MONITORS from £220</b>			
Monochrome Monitors from £54.00			

**PHONE US FOR BEST DEAL**

**DOT MATRIX PRINTERS**

<b>OKI*</b>		<b>SEIKOSHA GP700A Colour</b>	
M82A (120 CPS)	£262.00	GP-100A	£210
M92P (160 CPS)	£425.00	GP-100 (VIC 20)	£175.00
Tractor	£50.00	<b>MANNESMAN TALLY</b>	
M83A (12 CPS)	£420	MT80 (80 CPS)	£198.00
(120cps Friction, removable Tractor and RS232 and Centre/Par standard)		MT160 (160 CPS)	£417.00
M84P (200 CPS)	£650	MT180 (160 CPS-132 Col)	£600.00
<b>ANADIX*</b>		<b>EPSON</b>	
DP-9000 B/(180 CPS)	£850.00	Epson RX80T (100cps)	£224.00
DP-9500 B/(180 CPS)	£893.00	Epson FX80 (160cps)	£340.00
DP-9625 B/(240 CPS)	£1155.00	Epson RX80FT	£256.00
<b>BROTHER</b>		Keyboard	£210.00
EP22 Portable (Ideal for Atari/Commodore 64/Vic Nec PC8201/Sharp PC1500 Etc.)		Epson FX100FT 160cps)	£480.00
Printer/Typewriter/Calculator	£130.00	Epson RX100FT (100cps-136 col.)	£399.00
EP44 (16 CPS)	£189.00	Epson LQ 1500 (200cps)	£960.00
HR 5 (30 CPS)	£145.00	Epson I/F and accessories from	£29.50

**TECHNICAL ADVICE**

If you require help in selecting correct PRINTER/SHEETFEEDER/MONITOR or even I/F CABLE for your existing computer Tel our HOT LINE 01-455 9824

**DIGITEK ACCESSORIES FOR APPLE COMPUTERS**

64K RAM CARD	£149.00	RS232 High Speed Ser I/F card	£85.00
128K RAM CARD	£299.00	Screen master 80	£129.00
PAL Colour Encoder	£78.00	I/F Cards for Epson/Nez/Tec Microline	£98.00
Z80 Expander card	£89.00		

**SOFTWARE**

<b>Word Processing APPLE</b>		<b>Word Processing IBM</b>	
Applewriter 1.1	£55.00	Wordstar	£285.00
Applewriter 2	£85.00	Easywriter II	£230.00
Wordstar	£245.00	Volkwriter	£149.00
Applewriter Ite	£105.00	Mailmerge	£140.00
<b>Word Processing SIRIUS</b>		EasySpeller	£115.00
Supr Calc	£140.00	Superwriter	£230.00
Multiplan	£149.00	Epson HX20	£115.00
Wordstar	£289.00	Word Processing	£85.00
Select	£285.00	M Iist (cassette)	£30.00
Mail Merge	£85.00		

**GOODS FULLY GUARANTEED PRICES EXCLUDING VAT AND P + P.**

Company and Government orders accepted by phone. Barclaycard Access Viss accepted by phone. Tel.: 01-455 9823

**MOUNTAINDENE**  
22 Cowper Street London EC2

**CONVERT YOUR 80-BUS SYSTEM TO 16 BIT WITH A COSTGOLD ADD-ON PROCESSOR BOARD.**

Run CP/M-86. Read/Write IBM PC compatible discs.

**CA802** £525  
8MHz 8088 Processor  
256K Bytes RAM  
serial port and real time clock  
EPROM based monitor  
Supports CP/M-86, concurrent CP/M-86 and MP/M-86

**CA801** £375  
8MHz 8088 Processor  
128K Bytes RAM  
EPROM based monitor  
Supports CP/M-86  
Can be expanded later to CA802 spec

CP/M-86 for CA801/CA802, including utilities £199

**SPECIAL OFFER... CA802 and CP/M-86** £695

Either 80-bus format board enables retention of the Z80 card to run your existing software. Both cards will read or write IBM PC compatible discs & all Gemini formats. A 8088 bus expansion connector is also provided.

All prices include p&p but exclude VAT at 15%.

CA801 & CA802 are available now. Orders to Costgold Research, The Old School, Strettham, Cambridge CB6 3LD. Tel (035 389) 282/3.

Coming soon Concurrent CP/M-86.

**COSTGOLD RESEARCH, THE OLD SCHOOL, STRETTHAM, CAMBRIDGE CB6 3LC.**

Tel: (035 389) 600

● Circle No. 157

**UNIVERSAL COMPUTER PRODUCTS**

**EPROM PROGRAMMER** for 2716, 2732, 2764, 27128, 2532 EPROMS. This programmer can be very easily connected to almost any microcomputer, e.g.: OSIXP, PET, CBM, TRS 80, EXDUD, SWTPC, EXORCISER, NASCOM, MAXBOARD, AMICOS, ACORN ATOM, VIC 20, APPLE, JUNIOR, SYM, DAI, AIM, EXPLORER, HEALTHKIT, ZX 81, ABC and CBM 64. Control software in EPROM £ 6.50. **35.95**

**EPROM ERASER** erases 4 EPROMS simultaneously. **74.95**

**MONITOR** very professional, 12" **69.95** when purchasing also a 80-card

**PRODUCTS for the CBM64!**

**80-COLUMN/GRAFICCARD**

- Digital clock
- Mispossibility of 80-column screen with Hires CBM64-screen (also in colour)
- Grafic pictures; can be switched to background
- Upper line can be locked (for comments)
- Adjustable line spacing for greater clarity on text screens

**FREE ADDED!** wordprocessor + calculation program

**82.50**

**both CBM64 & VIC20**

**EPROM CARD**

two 2k/4 k EPROM sockets. Addresses are changeable. **9.15**

**EXPANSION UNITS**

with 2 slots with 5 slots, fully buffered, switches for deselection slots, and on-board power supply. **9.15**

VIC 20 \$445 \* CBM64 \$250

**PRODUCTS for the VIC20!**

- 32 kBytes
- switchable
- cased
- low power consumption
- goldplated connector
- unbeatable price from ZERO!

**39.95**

HOME- AND BUSINESS SOFTWARE AVAILABLE FOR RAM- AND COLUMN CARD!

**40/80 COLUMN CARD**

Turn your VIC 20 into a professional computer. 40 or 80 columns instead of 22, very sharp and stable picture. **24.35**

**64 k RAM + 2 k EPROM**

With software for RAM-files. Easily connected. other ZERO products: ●Printerbuffers, RS232 & cent. ●Epromcopiers. ●More is coming..... **33.50**

**zero**  
**ELECTRONICS**  
149 KINGSTREET  
GT. YARMOUTH NR30 2/L  
TELEPHONE:(0493)-842023

- All prices include VAT. Shipping costs £ 1.50
- Supplier to schools, universities and government departments.
- We have good documentation of all our products, free of charge.

Dealer inquiries invited

ZERO Companies: The Netherlands: Tel. 01892 - 5333 - Germany: Tel. 02821 - 28926 Sweden: Tel. 0382 - 40037

● Circle No. 156

● Circle No. 158

# Learning the micro way

Lorraine Boyce asserts that the use of microcomputers in education could alter learning processes in ways previously unanticipated.

PARENTS AND TEACHERS who already strive to keep up with technological developments affecting their children are usually painfully aware that the effects are also relevant to the whole planet. All kinds of prejudices and misapprehensions have their roots in the early nurturing and conditioning of children. Maybe the advent of microtechnology into education allows us a last chance to counteract some of our previous errors.

Daniel Chandler's book *Young Learners and the Microcomputer*, available from Open University Press, presents a challenge to conventional assumptions about the educational use of microcomputers which has implications for anyone concerned about the future. He looks forward to the golden age which might emerge in the 21st century should we explore the true potential of home and school micros for learning. His research with children in Europe and North America leads to the questioning or rejection of many common uses of micros in education.

## Self-expression

The notion of computer literacy could be replaced by a true literacy: fluent self-expression which may be enhanced by early use of the micro. Restrictive drill-and-practice software hinders a child's development of independent and logical thought. They need an immediacy and relevance of response similar to that experienced when using the spoken word with other children or adults. Surely the last thing we really want is for children to associate the marvel of the micro with software such as the kid-proof spelling program which, at the end of a session, "summarises the things you have done wrong"?

Instead of being replaced with a derisive error message the bogey of the red cross can fade away for ever as a child plays with Logo, with adventure games such as Granny's Garden, with databases and with word processing. Word processing has proved a route to salvation for many young would-be writers struggling with spelling and syntax as well as with handwriting.

Daniel Chandler claims not to be an evangelist, and those looking more for information than inspiration will also find it in his book. Besides indices of topics and of names, and the best and fullest glossary I have seen yet, there are copious notes on the text and no less than six appendices. A beginner in the field will find useful basic information and the more experienced will probably be able to pick up several fresh ideas.

## Carpet-baggers

Unfortunately Appendix 1 gives a software check list against which few of the programs currently found in schools will stand up well. Dare we hope that the flourishing carpet-baggers of educational software will take note? At present far too many of their wares will flounder on points such as: "Is the program likely to stimulate creativity?", or: "Would it be worth using many times?", not to mention: "Is the use of language appropriate for the intended users?"

Both within and beyond the teaching profession there is a feeling that schools are failing in their purpose and that within the next few decades radical changes will be seen. Chandler argues that whether we see basic education as a formal training to take place in schools, or prefer the viewpoint of those who want learning to return to the home, the micro is certain to play a major part. The important thing is to make sure that the micro strikes the right balance when used by the child, whatever the environment.

## One between two

Many teachers hold with the idea that even when schools can afford single hands-on experience for all pupils the minimum number at a machine should still be two. Seymour Papert goes further in considering the possibility of certain kinds of software intruding into and atrophying family relationships and emotional and social development. Lack of cuddling and loving attention in early infancy is now recognised

as a potential cause of physical stunting. Papert warns that lack of friendly personal contact later may result in "a generation of psychotic children".

Both Papert and Chandler emphasise that the aims of educational micro-computing should be to have children use technology to aid and extend their thinking, their decision making and their problem solving. Children must be in control of their micros, never the other way round. Software should promote discussion with their peers, not stunt speech or relegate it to a mere means of gaining assistance from an adult. The computer should enhance the work of both teachers and children. How could a class arrive at and test criteria for the "strongest conker in the world" save with an information-retrieval program?

## Concerned parents

Let us explore flexi-schooling as a way of involving concerned parents in the education of their children. Only the blinkered could see this as a threat to hard-pressed teachers. Most must recognise it as a complementary contribution from the person who originally produced the child and who can therefore be assumed to have a continuing interest in the child's welfare.

Learning has for too long been allowed to shrink into something separable from living. Can we not try to elevate learning once again to a proud process lasting from the cradle to the grave, or the maternity ward to the crematorium? We certainly have the necessary knowledge and technology, can we not muster the will?

Perhaps *Young Learners and the Microcomputer* could point the way, although it has the drawback of any printed word: now it is fossilised. The author records that as soon as he completed the final revision the book became "a map of the past". He would be delighted to hear that you are already using micros in creative work with children, enabling them to approach the future with confidence in themselves and their ability to solve problems, confirming for them the value of collaboration and play. If you are, please let him know.

## Telephone Claire Notley on 01-661 8163

### ADVERTISEMENT RATES

<b>Display Rates</b>	
£15.00 per single	
Column Centimetre	
Minimum 5cm x 1col	
One Insertion	£15.00 per scc
Three Insertions	£14.25 per scc
Six Insertions	£14.00 per scc
Nine Insertions	£13.50 per scc
Twelve Insertions	£13.00 per scc

**Micro Ads.**  
 Linage 25p per word minimum of 15 words.  
 Prepayable.

### Copy Date

Shopwindow advertisements for the August edition will be accepted up to 20th July, subject to space being available.

Post to  
 Practical Computing, Classified  
 Department, Room H211, Quadrant House,  
 The Quadrant, Sutton, Surrey SM2 5AS.

## Superbrains



MICROMODS LTD.,  
 53 ACTON RD., LONGEATON, NOTTINGHAM  
 NG10 1FR. Tel: 0602-724264

• Circle No. 190

## : GO FORTH & \* ; THE LANGUAGE OF TOTAL CONTROL

Laboratory Microsystems FORTHS — the professional FORTHS complete with editors, assemblers, turn-key compiler, many system utilities, multi-tasking, and extensive documentation. These FORTHS are available for 8080, Z80, 8086/88, and 68000 processors using CPM-80, CPM-86, MSDOS/PCDOS, or CPM-68K.  
 CPM-80 £60 CPM-86 £105  
 MSDOS/PCDOS £105 CPM-68K £190  
 NEW — FORTH+ packages have 32-bit stacks and can access the processor's full address space for both program and data. CPM-86/MSDOS/PCDOS £190  
 CPM-68K £290

Nautilus Systems Cross-compilers — transport FORTH to different processors, generate ROMmable code, these compilers will run on any of the FORTHS above. The complete development system — a real time saver. Choose targets from — 6502, 8080, 8086/88, Z80, 6800, 6301/6801, 6809, 68000, 1802, Z8, 8070, 9995/99000, Z8000, LSI-11. First compiler from £290, additional targets from £95.

NEWBRAIN FORTH in PROM — includes screen editor, full integration to NEWBRAIN i/o handlers, complete Z80 macro-assembler, floating point, graphics, decompiler, utilities, and manual — £55 + VAT

DIY FORTH kits Installation manual — How to do it, model, definitions, editor £7 Source code listing for one processor — choose from 6502, 6800, 6809, 8080, Z80, 8086/8088, 9900, 1802, 68000, Z8000, VAX, Apple II, LSI-11, Eclipse £7

Comprehensive range of FORTH books includes —  
 'Starting FORTH' by Brodley — the classic £16.25  
 'Systems Guide to f/g-FORTH' by Ting £22  
 'FORTH Programming' by Scanlon £13.50  
 'Threaded Interpretive Languages' by Loelger £20.75

**JPE** MicroProcessor Engineering Ltd  
 21 Mantley Road Shirley  
 Southampton SO1 5AP  
 Tel: 0703 750084



• Circle No. 191

## REPAIRS & SERVICE

- \* COMPUTERS (Business & Personal)
- \* DISC DRIVES (5¼ & 8")
- \* VDU's
- \* MONITORS
- \* PRINTERS
- \* S100 BOARDS
- \* EPROM PROGRAMMING
- \* MAINTENANCE CONTACTS

48 hour service for alignment and test of disc drives

### A.N. ELECTRONIC & COMPUTER SERVICES LTD

1308 North Lane, Aldershot, Hants  
 Tel: Aldershot (0252) 25608

• Circle No. 192

## OPEN HOUSE FOR NOVICES AND BEYOND

Choose your time — day or evening.  
 Learn at your own pace on OSBORNE, RAIR or BBC BASIC, D BASE II, SUPERCALC, WORDSTAR, Graphics  
 Introductory Course £45  
 Also evening club

Brochure from:  
**MICROCOMPUTER ADVISORY CENTRE**

Polytechnic of the South Bank  
 Borough Road,  
 London SE1 0AA

or ring: 01-928 8989 ext. 2468

• Circle No. 193

## TELEVIDEO EQUIPMENT

As new and under maintenance contract

TS816/40 £5550. TRS 806/20 £3000.  
 TS 806/10 £2500. TS 800A £900

VAT extra

Contact Mr Lando on

01-580 1654.

• Circle No. 194

## Every computer needs CHATTERBOX II

"Listen creep, I am the leader..."



**NEW! EXCLUSIVE!** PITCH CONTROL

## CHATTERBOX II™ can say anything!

Genuine phoneme synthesis - not just recorded speech - hence unlimited vocabulary. Programmable pitch for more natural intonation (exclusive to Wm Stuart Systems) - solid tone cabinet for quality sound - integral beep/music amplifier. PLUS expansion socket for BIG EARS voice recognition system. Full instructions technical notes and software supplied with this outstanding educational unit.  
 DEALER ENQUIRIES WELCOME

As seen on BBC TV "Computer Programme"

## \*BIG EARS\*

SPEECH INPUT FOR ANY COMPUTER



Hugely successful Speech Recognition System, complete with microphone, software and full instructions.

**BUILT TESTED & GUARANTEED**  
 PLEASE STATE COMPUTER: UK101, SPECTRUM, ATOM, NASCOM2, Vic 20, Micron, ZX80/81, PET, TRS80, M280K, APPLE II, BBC MICRO

## ZX81/SPECTRUM

MUSIC SYNTHESISER (Stereo) + 16 LINE CONTROL PORT

Play 3-part music: sound effects, drums etc. Full control of attack, decay and frequency. Input/Output lines provide control and monitor facility for Home Security, Robot Control, Model Railway etc. etc. Works with or without 16K RAM.

Full instructions/software included. Add keyboard to make a live performance polyphonic synthesiser!  
 Note: up to 3 units can be used simultaneously, giving 9 music channels & 48 I/O lines

## SOFTWARE

**THE COMPOSER** Synthesiser Music Programme. Enter & play 3-part harmony. Includes demonstrations (Spectrum ZX81 recommended) £7

**TALKING HANGMAN** For Chatterbox! The classic game claims its victims with a dry vocal accompaniment (Spectrum) £6

**ZX ARP/DRUM/SEO** Fascinating synthesiser demonstrations. Generates automatic sequences and plays from keyboard. Some weird effects (Spectrum) £6

**CHROMACODE?????** Can you defuse the bomb by cracking the secret combination before time runs out? With Chatterbox voice output (Spectrum) £6

**COLOUR MODULATOR** RGB in, PAL/UFH out (not for ZX)

Please add VAT at 15% to prices. Barclay/Access orders accepted by telephone

**WILLIAM STUART SYSTEMS Ltd**  
 Quarley Down House  
 Cholderton  
 Nr. Salisbury  
 Wiltshire, SP4 0DZ  
 Tel: 098 064 235

Kit £16 BUILT £22  
 All enquiries S.A.E. please

• Circle No. 195

## KINGSLEY ENTERPRISES

Mail Order Discs  
Prices are for boxes of 10 discs

Soft Sector	Nashua	Xerox	Dysan	Centech
5.25" Diskettes				
SS/SD 48	15.00	22.00	22.00	25.00
SS/DD 48	17.00	19.00	23.00	25.00
DS/DD 48	19.00	24.00	31.00	31.00
SS/DD 96	24.00	25.00	32.00	35.00
DS/DD 96	25.00	31.00	40.00	40.00
8" Diskettes				
SS/SD 48	20.00	26.00	-	-
SS/DD 48	21.00	23.00	30.00	30.00
DS/DD 48	22.00	27.00	35.00	37.00

Sony 3.5" (Apricot) Diskettes £40.00

Add carriage (£1 per box) and V.A.T. (15%)  
Prices correct at time of going to press  
Please write for full-range price list

**KINGSLEY ENTERPRISES**  
87 Whitefield Road  
Stockton Heath  
Warrington  
WA4 6NB

**Organise your files on  
Centech Colour  
discs**

● Circle No. 196

### PCALC—The Spreadsheet for the NEC PC-8201A, Olivetti M109 Tandy 100.

Now your portable computer can be a complete system — with PCALC, a powerful spreadsheet program specially designed to make the most of your NEC PC-8201A, Tandy Model 100 or Olivetti M-10 (16K RAM required). Supplied on cassette, complete with an easy-to-understand manual. Priced at only £25.00, PCALC is the low cost alternative to expensive ROM based software.

**CAPRA-CINDERSTAN ASSOCIATES**  
5 OLIVER COURT  
SOUTH HILL PARK GARDENS  
HAMPSTEAD, LONDON NW3 2TE

● Circle No. 197

### SCIENTIFIC SUBROUTINE LIBRARY

#### VOLUME 1 — STATISTICS AND FITTING FUNCTIONS

Mean, SD, normal distribution, partial expectation, Chauvenets criterion, least squares fit to polynomial and arbitrary function, repetitive least squares fits, covariance matrix, chi-squared statistic, matrix inversion, solution of linear simultaneous equations.

#### VOLUME 2 — LINEAR PROGRAMMING

Reduction of a simplex tableau, integer programming, parital integer programming, conversational linear programming systems, least cost mix problem.

#### VOLUME 3 — FURTHER STATISTICS

Ranking, quantiles, frequency, correlation coefficient, T, chi-squared and F distributions and their inverses, T test, chi-squared test, Wilcoxon test, linear and multiple regression, ANOVA 1-way and 2-way.

#### VOLUME 4 — TRANSFORMATIONS AND SORTING ALGORITHMS

Fourier and Fast Fourier transforms, numerical integration and differentiation, harmonic analysis, interpolation, coordinate transformations. Exchange sort, Quicksort, Shellsort, Tree sort.

All routines are written in BASIC for easy implementation on any machine.

Machine readable source code £75 + VAT per volume (Most disk formats now available)

Manuals including full source listings with implementation notes and documentation £25 per volume

#### CP/M TO DEC FILE TRANSFER

Software to read and write RT-11 format RX01 diskettes under CP/M. Supplied on 8" SSSD diskette - £25 + VAT.

#### ACT APRICOT VT100 TERMINAL EMULATOR

Allows the APRICOT to act as a terminal with file transmission and reception £50 + VAT  
Write or phone for further information on any of our products.

**MICRO LOGIC CONSULTANTS LTD.**  
57, Station Rd., Southwater, Horsham,  
W. Sussex RH13 7HQ  
Telephone 0403 731818

● Circle No. 198



Flip'n'File 15 illustrated  
Available for 10, 15, 25, 50 disks

## EXCITING NEW

Disk Storage from **£3.99**

WABASH DISKETTES

from **£1.13**

Price list from

Disk Direct  
Freeport  
Woking GU22 9BR  
Tel: 04862 26626



● Circle No. 202

### Build Your Own PC

PC/XT compatible mother board (blank).....£99.95  
B&T with 128K Bytes of RAM.....£599

Full range of PC compatible boards available.

Strip Unit.....£1499.00  
PC/XT compatible mother board with 128K bytes RAM (expandable on board to 256K), eight expansion slots, keyboard, case and power supply.

Basic Unit.....£1899.00  
As strip unit, plus one 320K disc and colour/graphics card.

Upgraded Unit.....£3499.00  
As basic unit, plus 10M byte hard disc.

\* FREE delivery within UK \* All prices fully inclusive \*  
Dealer enquiries welcome.

#### CONQUIN SOFTWARE

14 GOOOWOOD CLOSE, MORDEN, SURREY, SM4 5AW  
NO CALLERS PLEASE. PHONE 0524 381423

● Circle No. 199

### MICROCOMPUTER INSURANCE

Comprehensive cover at a reasonable premium:

- All Risks Cover (incl. Transit) — up to £8,000 for £20
- Increased Cost of Working — to reinstate lost data
- Breakdown & Derangement — alternative to maintenance agreement

Write with details of equipment to:

**Geoffrey Hoodless & Associates**  
Freeport (no stamp required)  
Woking  
Surrey GU21 3BR  
Tel: Woking (04862) 61082 (24 hrs)

● Circle No. 200

## Enhance your Superbrain

Compartar Chaining  
Adaptors

13 Megabyte Tape  
Back Up Unit

S100 Bus Adaptor  
Supervid/Superbios

8" Drive Interface Kit  
Graphics Boards

Plastic Cover

Complete Add-on Boxes:  
2 Floppy Drives, Cables  
& Bios:

QD (Double Sided) or  
DT (Double Tracking) or  
8" (IBM Format) plus  
Cable with female socket

Winchester Add-on  
Boxes: 5, 10 or 30 MB

For further  
details  
contact

**SUPERBRAIN  
ICARUS**  
Computer Systems Ltd.  
39-51 Highgate Road, London NW5 1RT  
Tel: 01-267 0177/7581  
Telex: 264209

51

● Circle No. 201

### DYSAN DISKS

from **£1.47**

VERBATIM

DATALIFE

from **£1.51**

Ribbons for

MX100 £5.98/ea

IBM 82C £9.50/doz

Lift off tapes £5.98/doz

Price List From

Disk Direct  
Freeport  
Woking GU22 9BR  
Tel: 04862-26626



● Circle No. 203

### DISKETTES

VERBATIM 5 1/4"	VERBATIM 8"
SSDD BOX 10 £21.80	SSDD BOX 10 £30.60
DSDD BOX 10 £31.00	SSDD BOX 10 £30.90
	DSDD BOX 10 £36.10

Prices include delivery but exclude VAT

SPECIAL OFFER — COMPUTER TABLE FOR HOME OR OFFICE. 2 TIER FULLY ADJUSTABLE IN TEAK OAK OR WHITE MELAMINE.

**£36.50**  
+ VAT

For full price list phone  
or write



### COBRA

Office & Data Products Ltd.,  
Lichfield House,  
21, High Street,  
Amblecote,  
Stourbridge, DY8 4DE  
Tel: 03843 74880

● Circle No. 204

### MJ MICRO SUPPLIERS

Disks Wabash — Box of Ten Dysan — Box of Ten	
SSSD 5.25"	15.10 SSSD 5.25" 19.50
SSDD	19.16 SSDD 21.50
DSDD	21.60 DSDD 21.50
Samsom Data Binder	Disk Storage Box 5"
9.5" x 12" ea.	1.15 ABA 30/40 16.00
14.5" x 11" ea.	1.22 ABA 60/80 22.00
Listing Paper 2000	Labels 1000
12" x 8"	13.50 3.5" x 1.5" 4.95
11" x 9.5"	11.95 4" x 1.5" 5.25
11" x 14.5"	14.25 5" x 1.5" 5.50
A4 Clean Edge	24.95
Printer Ribbons	Scotch Data Cartridge
Anadex DP9500	7.28 DC300A 19.00
Epson MX/RX/FX80	4.50 DC300A-HD 21.00
Epson MX/RX100	6.95 DC300XL 25.00
MT120/40/60/80	5.25 DC300XL-HD 27.00

Full range of disks, stationery & ribbons available

Prices excl. P&P and VAT.

Cash with order. Add P&P & 15% VAT to prices.

For all your supplies, write for full price list

**MJ MICRO SUPPLIES, FREEPOST (BS3661),**

Nailsea, BRISTOL BS19 2BR.

No stamp required

Tel: Nailsea (0272) 857354 24 hr. Answer Phone

● Circle No. 205

# SHOP WINDOW

compare northern computers... considerate, competitive and committed!

THE Showroom for all the leading micros

- ◆ BBC ◆ Electron ◆ Sinclair ◆ VIC64
- ◆ Dragon ◆ Printers ◆ Disk Drives
- ◆ Plenty of Software
- ◆ Books/Games ◆ Help & Advice
- ◆ Secondhand Computers

Churchfield Rd FRODSHAM Ches WA6 6RD Telephone: FRODSHAM 0928 35110

THE computer centre of the NORTH

● Circle No. 206

## The Incredible HULK (£25 + VAT)

HULK is the poor man's knowledge engineer. Knowledge engineering is the new approach to software design which underlies the success of recent knowledge-based expert systems.

The HULK package (so called because it Help Uncover Latent Knowledge) offers users of the BBC and Torch microcomputers a low-cost route into knowledge engineering. It will enable you to build up and test a set of decision rules which can be used for prediction or classification.

Thus HULK takes the donkey work out of developing a 'knowledge base'. Think of it as a research assistant.

This is what the Practical Computing software review said about HULK:

"It is very quick and interactive and justifies its name — it does help uncover latent knowledge."

"It can genuinely help people to make sound decisions — and bad decisions are extremely costly in many enterprises." (March 1984 issue.)

HULK is available at £28.75 including VAT for BBC/B (preferably with disks) or Torch microcomputers. We will also make it available for the QL as soon as Uncle Clive lets us have one! Cheque/PO with order from:

Warm Boot Limited  
40 Bowling Green Lane  
London EC1R 0NE

(Also distributed by Brainstorm Computer Solutions, London N7)

● Circle No. 207

## IS YOUR MAINS BUGGING YOU?

Mains-borne interference causes annoying data corruption and program crashes. Voltage spikes and power surges can cause permanent damage. Protect YOUR equipment:-

**PROTECT-ADAPTA** with 3 13Amp sockets, absorbs power-line spikes and surges. £13.95 for 1st, £9.95 for 2nd. (p&p 85p)

**4-WAY SUPPRESSOR UNIT (13A)** with 4 sockets, spike absorber and suppressors. £23.95 for 1st, £19.95 for 2nd. (p&p £1.50)

**PROFESSIONAL SUPPRESSOR UNIT(3A)** Multi-stage filter networks, high power spike absorbers, and earth-line choke — the best! £34.95 for 1st, £29.95 for 2nd. (p&p £2)

All units to BS613, also for hi-fi, videos, office equip. etc.

VAX Co, Hogarth House(F), Porchester Rd., Nottingham. NG3 6LE

● Circle No. 208



DIGITAL DRAWINGS is C.A.D. using the BBC microcomputer and a dot-matrix printer. powerful but easy single-key mnemonic commands. drawing storage on disc or cassette. accurate scale drawings to almost any scale. arcs, circles, dimensioning, grids, hatching, ellipses, polygons, rectangles, curve-splicing, macros, symbols, text, shading, measurement, repetition, etc. 68-page user guide. available on disc: £75; EPROM: £95; or cassette: £65



3-D VIEW allows wire-frame perspectives to be generated, viewed from any angle of distance, saved on disc or cassette, and printed using a dot-matrix printer. view displayed while entering data. unlimited viewpoints



available on disc: £35; or cassette: £30

Now available for Walters WM80 as well as Epson, Star and NEC printers: state printer make & model and media & filing system with order or write for more details. add £2.00 p&p and VAT. price rise 1st June — write now to **IBBOTSONS DESIGN SOFTWARE "The Byre"** Ecclesbourne Lane Idrighay Derbyshire DE4 4JB

● Circle No. 209

**dBASE II** — by Ashton Tate is the top selling database package. But it from **AQUA Computing Ltd**, the dBASE specialists.

<b>dBASE II</b>	£375.00
<b>DBPlus</b>	£125.00
<b>DBFLIST</b>	£30.00
<b>DBAccel</b>	£50.00
<b>dBASE II User's Guide</b>	£22.00
<b>Everyman's Database Primer</b>	£12.00

Any one of the last 4 items is **FREE** if you buy your copy of **dBASE II** from **AQUA** by July 1.

**DBPlus COMPRESSES/DECOMPRESSES dBASE II** files to 30/40% of original size; **SORTS** any dBASE II file up to 15 times faster; **MODIFIES** structures easily — complete with manual. Pays for itself in a few weeks.

Are your files scattered over several disks? **DBFLIST** compiles a master catalogue of all your dBASE files. Can save you hours of searching for that 'Lost file'.

**DBAccel** converts dBASE II. CMD file(s) into a single level format for much faster execution; **Overlay** control can be selective. Program size is limited only by available memory. Reduces running times by up to 50%.

**dBASE II User's Guide** is one of the best manuals on dBASE II; Has sold over 17,000 copies in the US; Written by Arthur Green, a leading US expert on dBASE courses. In stock now.

**dBASE II Beginner's Guide**, published by Ashton Tate, is essential for every serious dBASE II user.

For software products (dBASE II, DBPlus, DBFLIST, and DBAccel) add VAT to prices. Specify machine and diskette format (SD/DD, 5.25" or 8"). No extras for packing or postage in UK; add £5.00 for overseas. Further details available on all products. Pay by Cheque, PO, Access or VISA. Send to:

**AQUA COMPUTING LTD** (Dept PC5), 10 Barley Mow Passage, London W4 4PH (Phone: 01-994 6477).

● Circle No. 210

## HAVE YOU CONSIDERED BAR CODES



Bar-codes give a speedy and error free means of data entry and provide a foolproof method of identification for any item or document. Typical uses include stock control, libraries, filing systems, security & checkpoint verification, point of sale terminals, spare parts identification, etc. etc. Already most grocery products are bar-coded at source and many other areas of industry and commerce are following. Bar-codes will soon be commonplace.

### APPLE 2 PET BBC micro

A complete low cost bar-code identification system is available for these micros. It contains all the hardware, software and documentation needed to read and print bar-codes (using an Epson dot matrix printer). Most bar-code formats may be read and the system may easily be patched into an existing applications program.

£199.00 + VAT

\*\*\* NEW \*\*\* RS232 bar-code reader

This new stand-alone unit decodes the bar-code and converts it into ASCII for transmission to the host computer via a RS232 port. Complete with scanning wand, power supply & cables. Works with virtually any computer.

£385.00 + VAT

More information on these products is available on request. Please state your micro & area of interest. The decoder board is available separately to OEMs.

### DOT MATRIX & DAISYWHEEL PRINTERS LOWEST PRICES GUARANTEED!

EPSON FX80 RX80  
NEC 8023 STAR  
SHINWA CP80  
BROTHER TEC etc. etc. etc.

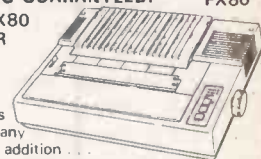

Our pricing policy is to match or better any other advertiser. In addition... enthusiastic and knowledgeable technical advice and backup is available to all our customers. Delivery is from stock to your door, often within 24 hours. Phone for a quote or write for full lists.

**ALTEK (PC) 1 GREEN LANE WALTON ON THAMES SURREY**  
please phone before calling  
(0932) 244110

**IBMPC 256K, 2x320K drives, VDU, UK keyboard, 60 day warranty. New dot matrix printer 140cps and near letter quality Fully integrated software. Full support available. Purchase sales nominal ledgers, payroll, ssp, fast data entry, word processor, mail list, modeller, stock control, cost £6195 price £3500 including vat. Near Oxford 099-386-345 Ad No.52M**

**TRS-80 Level II 48K RAM, lower case conversion green screen monitor, line printer VII, many books, £200 worth software, cost £1100, sell for £500 o.n.o. telephone 0908 318782 Ad No.53M**

**NEWBRAIN software specialist. Wordrite II word-processing £70.00. Mailmann / Wordritel for personalised mail / shots, £100.00. SS Software, 18 Fernbank Drive, Sheffield S31 9HG Ad No.53M**

**CORVUS 10MB Hard Disc with mirror option plus hardbox, suitable for Commodore IEEE interface. £850 + VAT Doncaster 69137 working hours. Ad No.49M**

**DUST COVERS TOP Quality, Made to measure. Printers, Drives, Keyboards £4.50. V.D.U.'s £5.50 inc. p+p Colours Olive or Navy. S&C Textiles Brookside, Diseworth, Derby. Telephone (0332) 810099 Ad No.50M**

**ROBUST purpose built stands for your micro, TV monitor, cassette, disk drive, Joystick, Etc. Phone or write for details. 2 Dolforgan View, Kerry, Newtown, Powsy. SY16 4DZ. phone 068 688 611. Ad No.45M**



# SHOP WINDOW

**PRINTER** for BBC. RS232 interface 180 CPS Bidirectional. Dot matrix 7x9. True descenders. Buffered. Various band rates. Adjustable traktors ideal for users requiring fast continuous printing. Phone. Crowthorne (0344) 776894. Ad No.35M

ZX81 owners' cassette based programme allows loading, editing and step by step debugging of machine code for 16K ZX81. Cassette and instructions £5 or S.A.E. for information Ben Thompson, 16 Tremlett Grove. London N19. Ad No.36M

**DBASE 2** expert offers to write your application program or help you write your own. Reasonable Rates R.Smith (0342) 313883 Sussex. Ad No.37M

**SHARP MZ80B** software masters including MBasic CBasic Sharp basic CP/M2.2 supercalc wordstar WdPro Mailpro sirs database pws more. worth over £1200 accept £200 Tel. 0222 552228. Ad No.38M

Exchange MotoGuzzi V50H 6700mls for disc and printer system compatible with BBC(B) phone 029-13-2298 6pm. Ad No.39M

**APPLE IIe**, 3 Disk IIs, 2 Controllers, Monitor III, extended 80 column card and 32K Microbuffer printer card for sale. Bought Nov 83, upgrading to Apricot. Offers 03596 669. Ad No.40M

**ANIMATED MUSICAL** Flashcard and Spelling Program for Commodore 64. Developed in collaboration with school and educational Psychologist. Suitable 1½ - 7 years. Cassette £4.50 disc £7.00. Toddlersoft, 1 Cat Lane, Ewelme Oxon OX9 6HX. Ad No.48

**SOFTWARE PURCHASE.** We require software in the areas of statistics, graphics, and spread sheet modelling for both micro and main-frame computers. Preferred language is FORTRAN but alternatives would be considered. If you have something even if only in subroutine form, please send a short description and an indication of the required price. Ad No.41M

**FOR SALE:** TRS-80 model 3 48K 1-disk high-res graphics including dot matrix printer; colour plotter and software. £1800 ono. Tel: (0966) 33441 after 7pm. Ad No.42M

**SINGLE CHIP 6803/6303** Processors fast macro assembler on BBC Operates from disc or tape. Easy to use. Line Editor included. Tape £15. Send for specification. M.J. Tyler, 2 Parkview, Cashes green, Stroud, Glos. 045-36-77257. Ad No.43M

**EPSON RX80** Printer, as new, under manufacturer's warranty, plus telewriter WP-Programme suit dragon, £195 (0843) 43793. Ad No.44M

**APPLE IIplus** 48K dual disks language card, 8088 co-processor, videx card, various software. £550 Bitton 5040 after 6pm. Ad No.46M

**APPLE IIe**, disk drive, green zenith monitor, printer interface, cables and manuals. Virtually unused £850 video genie, many games, editors, manuals £100 ono 051-430-7848 (Evenings). Ad No.47M

**BBC KEYPAD** 25-key add-on. S.A.E. for details to extron 16 Priory Park Bradford on Avon. Ad No.48M

## DISK COPYING SERVICE

Moving data and program files from one machine to another is often made difficult because different manufacturers have adopted different disk format standards.

We can copy your files to and from over 250 disk formats including CP/M, CP/M-86, MS-DOS, PC-DOS, ISIS, APPLE, SIRIUS, TORCH, APRICOT, HP150, DEC RT-11, and IBM BFF.

Disks are normally despatched on the day they are received.

Our charge is £10.00 + disk + VAT. Special prices for quantities.

For more information call us.

## GREY MATTER

4 Prigg Meadow, Ashburton, Devon TQ13 7DF. TEL. (0364) 53499

● Circle No. 211

**When replying to Classified advertisements, readers are recommended to take steps to protect their interests before sending money.**

**SELL IT WITH**

# Practical Computing

# SHOP WINDOW

# MICRO ADS. Order Form

**Classified Rates**  
 Linage 25p per word  
 Minimum 15 words prepayable.

**Display Adverts.**  
 Rate per single column  
 Centimetre: £15.00  
 Minimum 5 cm  
**SERIES** Discounts  
 Available on request.  
 Contact: Claire Nolley on  
 01-661 8163.

**Method of Payment**  
 Cheques etc should be made payable to BUSINESS PRESS INTERNATIONAL LTD. and crossed. I enclose herewith cheque/PO for

£.....

**Post to:**  
 Cut out the order form and return together with your remittance to: Classified Department, Practical Computing, Room H211, Quadrant House, The Quadrant, Sutton, Surrey SM2 5AS.

**Conditions of Acceptance**  
 Micro Ads are accepted from Private readers only and must be submitted on (or a photocopy of) this order form. All Advertisements must be prepaid.

Please insert the following advertisement in Practical Computing				LINAGE	
				Cost per insertions	
				1 Ins. ✓	2 Ins. ✓
				£3.75	£3.25
				£5.00	£4.50
				£6.25	£5.75
				£7.50	£7.00
				£8.75	£8.25
				£10.00	£9.50
				£11.25	£10.75
				£12.50	£12.00

**Box No. Required YES/NO**

NAME (Please include initials) \_\_\_\_\_

ADDRESS \_\_\_\_\_

✓ tick number of insertions required

**THIS FORM SHOULD BE RETURNED BY 20TH MAY FOR THE JULY ISSUE**

Company Registered Number: 151537 (ENGLAND). Registered Office: Quadrant House, The Quadrant, Sutton, Surrey SM2 5AS.

# Advertisement Index

<b>A</b>		<b>E</b>		<b>M</b>		<b>S</b>	
ACT Micromail	4	ESS Consultants	56	Marketing Micro Software	6,22,23,47	Sagesoft	85
ACT Pulsar	28			Master Systems	179	Sanyo Marubeni	1FC
ACT Software	18,19	<b>F</b>		Mercator Manage Consult	166	SCI (UK)	108
Aculab Ltd	25	Fraser Associates	32	Microdigital	166	Simmons Magee	88
Aculab Ltd	160			Microfast	46	Sinclair Research	60
Adda Computers	134	<b>G</b>		MicroMiracles	164	Smith W.H.	38,39
AKHter Instruments	40	GCC Cambridge	140	Micropacs	114	Software Ltd	B.C.
Acacia Computers	133	Gemini Marketing	154	Micro Peripherals Ltd	113C	Spectravideo	49
A-Line Computers	48	Gemini Micros	52,53	Microprocessor Eng. Ltd	150	Statacom Distrib Ltd	150
Appropriate Technology Ltd	139	Gt Northern Comp Serv Ltd	175	Micropute	142,143	S.T.C.	10,11
A.S.C.	48	GW Computers	172	Microsec	156	Sun Comp Services	79
ATA Ltd	51			Microvitec	138	Sunshine Books	164
Audio Genic	50	<b>H</b>		Microware	31,33	Swan Packaging	47
		Hisoft	75	Moore Paragon	35		
<b>B</b>		HMSystems	135	Moutaindene	180	<b>T</b>	
Barlismow Workspace	156	Hadene	147	MPI Ltd	34	Telesystems Ltd	95
Bee Bug	140					Thorn EMI	115
Brighton Computer Centre	175	<b>I</b>		<b>N</b>		Torch Computers Ltd	148,149
Bromcom	12,13	Institution of Analysts & Progs	166	Nationwide Dealer Group	178	Transam	89
				Northern Computer Fair			
<b>C</b>		Intec	9	<b>O</b>		<b>V</b>	
Calco Software	177	Interam Comp Systems	30	OKI Electric Europe	141	Vector International	36
Casio Electronics	42,43	Interface Systems	153	Opus Supplies	158	Vega Computers Ltd	75
Centralex	160	into Touch Ltd	53	Oryx	169	Verwood Systems	158
Civco Acre	114					Virgin Games	32
Computech	132	<b>J</b>		<b>P</b>		<b>W</b>	
Compsort	26,27	Jarogate	16	Page Plus	40	Wordsworth	150
Costgold Research	180	Jessop Microcomputers	131	Pinner Wordpro	47	Worldwide Computers	158
Cord Design Ltd	144			Powertran Cybernetics	11		
		<b>K</b>		Procom Technology	156	<b>X</b>	
<b>D</b>		KGB Micros	14	<b>Q</b>		X-Data	17
Data Design	186	Kingsley Enterprises	131	Qubie Distributing Ltd	20		
Data Efficiency	66					<b>Z</b>	
Dataproducts	44	<b>L</b>		<b>R</b>		Zero Electronics	180
Direct Disk Supplies	57	L&J Computers	176	Rair	41		
Disking International	170,171	London Computer Centre	54	Rosco Ltd	75		
Dragon Data	100,101	Longman	24				
Duplex (South) Ltd	48						
Dynatech Microsoft	114						



## DATA DESIGN TECHNIQUES LTD SPRING/SUMMER '84

# CATALOGUE

**ENHANCE YOUR MICRO COMPUTER  
SYSTEMS FROM A WIDE RANGE  
OF HARDWARE · SOFTWARE  
MICRO ADD-ONS.**

**Don't be without the DDT Catalogue.**

**Clip the coupon, write or 'phone for your copy NOW!**

DATA DESIGN TECHNIQUES LTD.  
Unit 16B, Norman Way,  
Severn Bridge Industrial Estate,  
Portskewett, Newport, Gwent NP6 4YS

**TEL: 0291 423781**

TLX: 497576

DATA DESIGN TECHNIQUES LTD.  
Please send catalogue to:

Name: \_\_\_\_\_

Company: \_\_\_\_\_

Address: \_\_\_\_\_

Tel: \_\_\_\_\_

Position: \_\_\_\_\_

I wish to be added to your  
mailing list — YES/NO  
Send to: DDT LTD.  
Unit 16B, Norman Way,  
Severn Bridge Ind. Est.,  
Newport,  
Gwent

# JUKI

## The Art of Daisywheel Printing



The new Juki Model 6100 letter quality daisy wheel printer, has full features you'd expect to find on a more expensive printer.

It can support word processing and graphic functions, print 20 CPS and use a simple drop-in daisy wheel.

The 6100 has 10/12/15 pitch, proportional spacing, utilizes IBM standard Selectric ribbons, has 2K buffer memory, parallel interface both tractor feed and serial interface are available as options.

That's only the beginning - Best of all, the low-noise Juki 6100 is extremely reliable.

Your can pay more, but you can't buy better than the Juki 6100.

### FEATURES:

- \*20 CPS (max.) print speed
- \*Bold and shadow printing
- \*Subscripts and superscripts
- \*Wordstar compatible
- \*Diablo protocols
- \*Auto Underlining
- \*Standard 2K buffer
- \*1 year parts and labour warranty
- \*Comprehensive user friendly manual



## Micro Peripherals Ltd

'THE POWER BEHIND THE PRINTED WORD'

69 The Street, Basing, Basingstoke, Hampshire RG24 0BY  
Telephone: 0256 3232 (12 lines) Telex: 859669 MICROP G

Call your local dealer NOW for full information on the Juki 6100 Daisywheel Printer or clip this coupon and we'll send you brochures and print samples.

Name.....

Address.....

187

..... Tel. No.....

PC7

# THE BOOK OF REVELATIONS

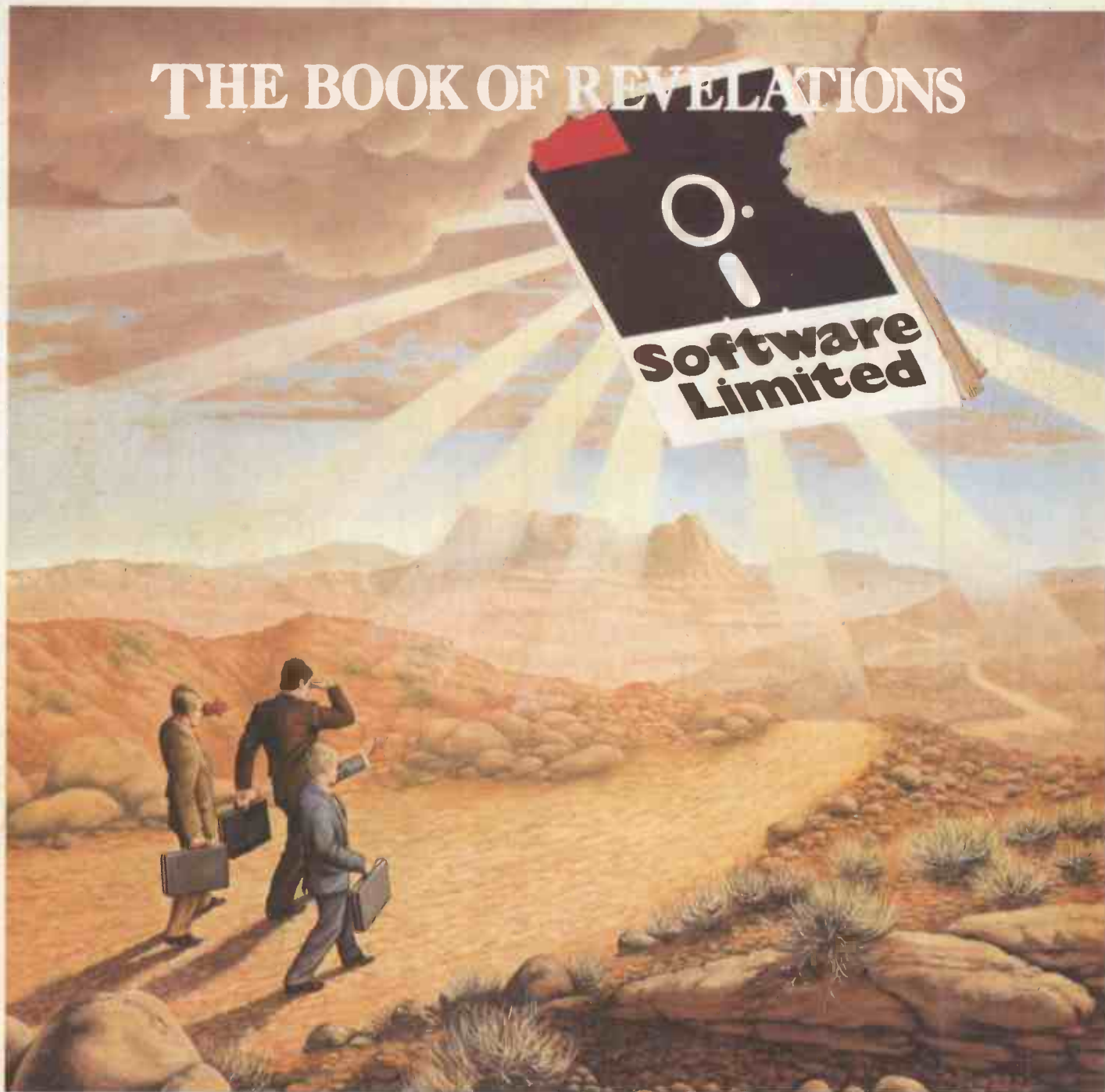

How do you see the role of the software you buy? Could your view be perhaps too narrow? If so, your business may not be benefitting fully from your hardware investment.

At Software Limited, we publish a catalogue that will shine a bright, broad light on the possibilities open to you.

We believe it's the most comprehensive and detailed catalogue available. In short, the state of the art today.

Armed with this information, and with the expert individual guidance Software personnel can offer, you've got a winning combination to set your business on the right road.

And that could be a revelation.

**More to choose from  
The only choice to make**

Telephone 01 833 1173/6  
01 833 2601/2 01 278 1371/2

No 2 Alice Owen Technology Centre  
251 Goswell Road, London EC1N 7JQ



Operating Systems: CP/M 80, CP/M 86, MS DOS & PC DOS